

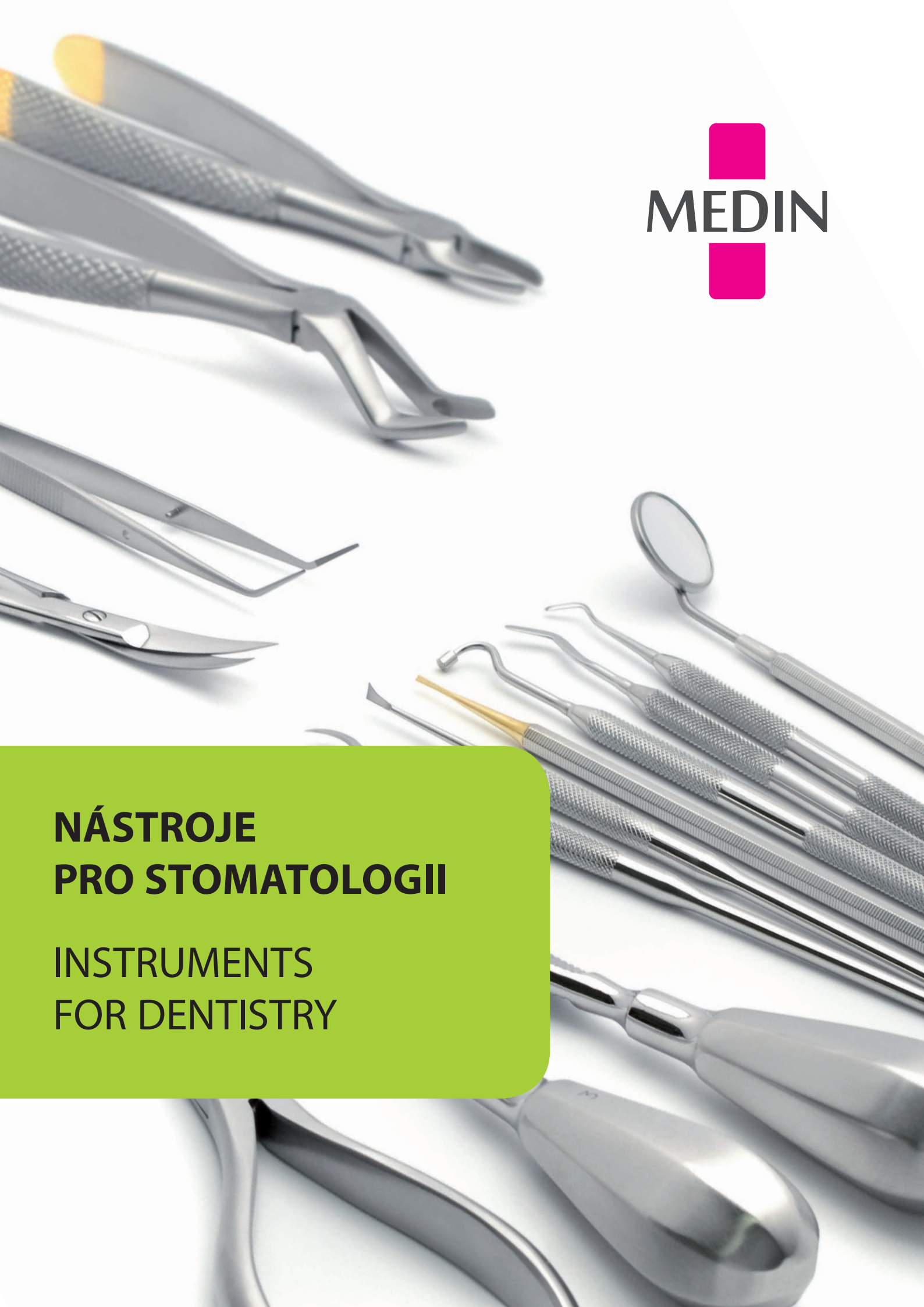

# **NÁSTROJE PRO STOMATOLOGII**

**INSTRUMENTS  
FOR DENTISTRY**

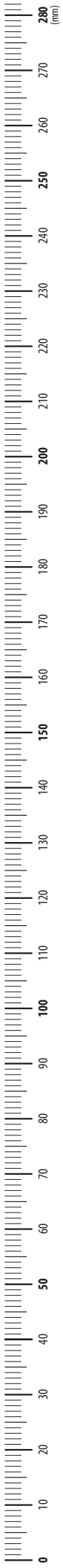





MEDIN, a.s.  
Vlachovická 619  
Nové Město na Moravě  
CZ 592 31  
Czech Republic  
IČO 43378030  
DIČ CZ43378030

**PRODEJ ČESKÁ REPUBLIKA**  
tel.: 566 684 327  
fax: 566 684 384  
e-mail: prodej@medin.cz

**EXPORT**  
phone: +420 566 684 336  
fax: +420 566 684 385  
e-mail: export@medin.cz

**[www.medin.cz](http://www.medin.cz)**  
**[www.medin.eu](http://www.medin.eu)**

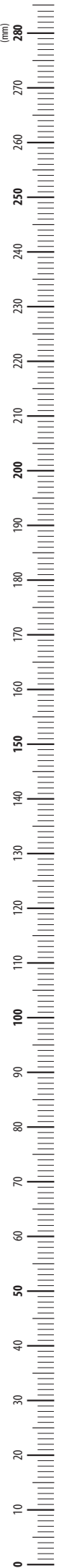

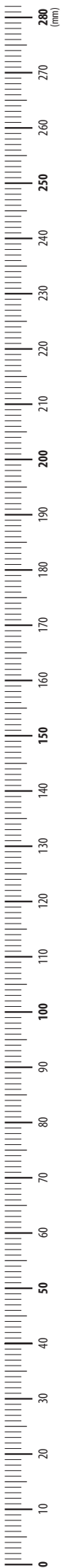

© 2012 MEDIN, a.s.; Všechna práva vyhrazena.

Dokument je určen pro obchodní účely MEDIN, a.s., údaje zde uvedené jsou informativního charakteru.

Žádná část tohoto dokumentu nesmí být reprodukována nebo publikována v jakékoliv formě bez předchozího souhlasu MEDIN, a.s. Zobrazení produktů odpovídá aktuálnímu stavu v době vydání tohoto dokumentu. Změny technických parametrů z důvodu dalšího vývoje jsou vyhrazeny.

Tiskové a typografické chyby jsou vyhrazeny.

© 2012 MEDIN, a.s.; All rights reserved.

This document should be used for commercial purposes of MEDIN, a.s.; the data mentioned in the document has informative character. No part of this document can be copied or published in any form without approval of MEDIN, a.s.

The product design may differ from those depicted in these illustrations at the date of issue. Adjustments, made from the reason of further developments of technical parameters, are reserved.

Printing and typographical errors are reserved.

# Od zubních vrtáčků po špičkové traumatologické implantáty – příběh firmy MEDIN

Dnes je MEDIN společností, která své produkty vyvážá do desítek zemí celého světa. Kdo a co všechno stálo za jejím úspěchem v posledních více než 60 letech?

## Zahájení výroby

Dne 29. srpna 1948 byl v Novém Městě na Moravě položen základní kámen podniku Chirana. Tak se začala psát budoucnost jedné z předních společností České republiky. V roce 1949 byla zahájena výroba zubních vrtáčků a fréz pro zubní laboratoře. Bývalý konstruktér Chirana Brno, pan Oldřich Truksa, se stal prvním ředitelem vznikajícího novoměstského závodu.

Už od roku 1956 se Chirana ve spolupráci s lékaři podílela na vývojových úkolech, které vyplývaly z **rozvoje lékařské vědy a nových operačních postupů**. Jedním z prvních úkolů se stal výzkum nástrojů pro cévní, hrudní a srdeční chirurgii, během kterého byly navrhovány například svorky na cévy, srdeční a cévní nůžky a další. Následující projekty se týkaly pohybového ústrojí (šrouby ke spojování zlomenin krčku kosti stehenní aj.) a zkoušek materiálů pro osteospektické pomůcky a kloubní náhrady (ramenní, loketní a kolenní kloub, kyčel). Pokračoval vývoj a výroba nástrojů pro neurochirurgii, plastikou a oční chirurgii.



Roku 1957 byl podnik rozšířen začleněním firmy Diamantrob, která se zabývala **patentově chráněnou výrobou diamantových nástrojů** pro zubní lékaře. Historie výroby těchto nástrojů v původním závodě v Berlíně sahá do let 1926–1950. Dalšími firmami, které vzala Chirana pod své vedení, se staly Pelc-Tyrolka a firma Koutný, produkující **speciální nástroje pro chirurgii**.

Vzhledem ke specifickému výrobnímu programu a vysokému podílu přesné manuální práce trvalo novým zaměstnancům vždy nejméně půl roku, než získali alespoň základní „cvik“ a zručnost. Proto na začátku 50. let vzniká nové učiliště s oborem chirurgický mechanik.



Prvními zahraničními zeměmi, kam Chirana exportovala své výrobky, se staly v roce **1950 Bulharsko, Rumunsko a Německo**. V roce 1958 se firma Chirana účastnila světové výstavy v Bruselu a získala zde stříbrnou medaili za soubor očních nástrojů. Následující rok obdržela Chirana Nové Město uznání 3. stupně na výstavě v Moskvě.

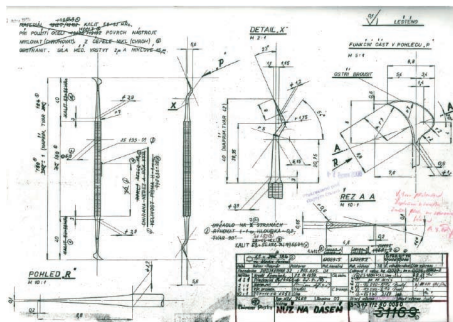

## Budování podniku

V roce 1968 byl zřízen holding Chirana Nové Město.

V 70. letech dominovala snaha o **rozšíření výroby**, což se odrazilo mj. i v počtu vyrobených vrtáčků – počátkem 70. let 5 milionů kusů a koncem 80. let už 9 milionů kusů. I díky stálému programu a monopolnímu postavení mohl podnik v té době vyrábět přes **4 tisíce druhů chirurgických nástrojů**, tedy množství, které se blížilo celosvětové potřebě.

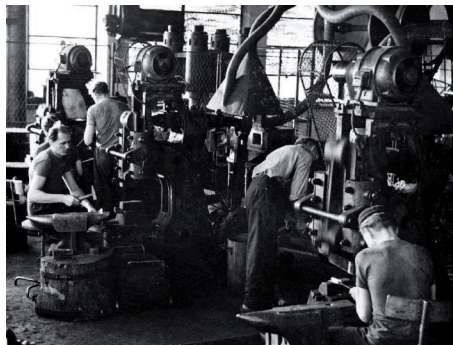

**Specialitou závodu byly jednoúčelové stroje**, které si podnik vyráběl sám v racionalizační skupině útvaru technického rozvoje.

Nově vznikající obor plastických hmot v 70. letech s sebou přinesl inovace i do výroby nástrojů. V rámci projektu vznikaly například skalpely s držáky z plastických hmot, zkumavky a antikoncepční tělíska.

V roce 1970 se začala slibně rozvíjet i spolupráce s předními nemocničními zařízeními. Roku 1972 požádal MUDr. Otto Gotfrýd z Fakultní nemocnice Brno o opravu některých strojů a zařízení. Výsledkem byla úprava geometrie břitů frézky na trepanaci lebky, díky které se podařilo o 30 minut zkrátit dobu nutnou pro operační zákrok. **Řada nástrojů byla pro svoje unikátní řešení patentována** a to samé platilo i pro zařízení a implantáty – například zařízení k lisování závěsů chirurgických nástrojů za studena či hřeb pro spojování krčků kosti stehenní.

Podniku Chirana se podařilo navázat dlouhodobou spolupráci s Vsesvazovým vědecko-výzkumným a zkušebním ústavem lékařské techniky v Moskvě. Kooperace zahrnovala například projekt výroby vybraných stomatologických a chirurgických nástrojů z titanu (do té doby se používala pouze nerezová ocel) a dále řešení technologie difuzního chromování uhlíkatých ocelí a korozní odolnosti lékařských nástrojů.

Výrobky byly **přísně kvalitativně posuzovány** podle zahraničních (západních) produktů, dle prototypových zkoušek a také ve zkušebním ústavu v Brně a na základě oponentních posudků z lékařských pracovišť.

## Privatizace

Na základě privatizačního projektu č. 2815 schválila Hospodářská rada vlády České republiky dne 24. března 1992 transformaci státního podniku Chirana Nové Město. **Vzniká tak firma MEDIN**, vlastněná 154 zaměstnanci podniku.



V 90. letech dochází k silnému rozvoji vývoje a výroby traumatologických implantátů. V roce 2006 MEDIN, akciová společnost, kupuje společnost WALTER Medica (firma vzniklá z projektu zdravotnické známého výrobce leteckých motorů WALTER), a vstupuje tak i do oboru kvalitních ortopedických implantátů.

*Dnes je MEDIN moderní českou firmou s kvalitním lidským potenciálem a s mnohaletým know-how ve výrobě lékařských implantátů a nástrojů.*



# Jaké hodnoty vám předáváme společně s výrobky?



Každý nástroj či implantát projde během zpracování rukama řady lidí a jeho výroba trvá až několik hodin. Nese tak s sebou i kus naší filozofie a základních hodnot.

## Zákazník

Našimi konečnými zákazníky jsou lékaři a zdravotní sestry z oborů chirurgie, traumatologie, ortopedie a stomatology. Snažíme se, aby řešení, která zákazníkům přinášíme, co nejvíce kopírovala jejich potřeby.

### Testování nového instrumentária



## Zkoušky tvrdosti výrobku

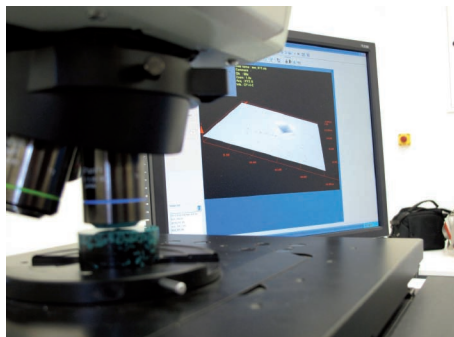

## Užitná hodnota výrobku

Celá cesta výrobku, od vlastního vývoje po distribuci, má jediný cíl. Dát lékařům do rukou kvalitní nástroj, který usnadní operační zákrok a pomůže při jejich vlastní práci.

## Naše okolí

Uvědomujeme si, že každá lidská činnost přináší změny v životním prostředí. Proto aplikujeme systém environmentálního managementu EMS. V rámci modelu Plan – Do – Check – Act Cycle neustále zkoumáme jednotlivé postupy ve firmě a hledáme ekologicky šetrnější varianty.

Sídlo naší společnosti se nachází v Novém Městě na Moravě, v dějišti řady sportovních událostí



## Profil společnosti

MEDIN je předním českým výrobcem lékařských nástrojů a implantátů. Čtyřmi hlavními produktovými pilíři firmy jsou chirurgie, traumatologie, ortopedie a stomatology.

Založení  
1949 – společnost Chirana

Sídlo  
Nové Město na Moravě

Tržby 2011  
300 mil. Kč

Certifikáty  
ISO 13485, ISO 9001, ISO 14001, CE značka

## Prodej

Prodej v rámci produktového segmentu:

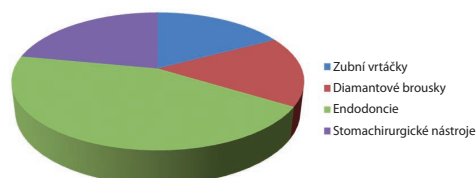

Prodeje v rámci jednotlivých exportních teritorií:

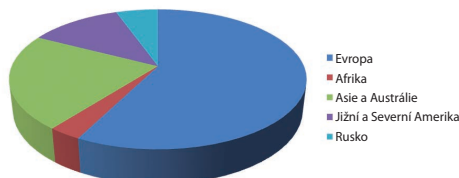

Podíl produktových skupin na celkových tržbách:

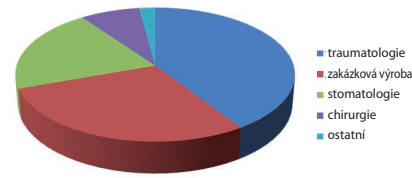

## Certifikáty

**DNV**  
**DET NORSKE VERITAS**  
**CERTIFIKÁT SYSTÉMU ŘÍZENÍ**  
Certifikát č. 98707-2011-AQ-CZS-NA  
Tímto se potvrzuje, že systém řízení ve společnosti  
**MEDIN**  
**MEDIN, a.s.**  
Vlachovická 619, 592 31 Nové Město na Moravě, Česká republika  
byl shledán shodným s požadavky normy dle:  
**ISO 13485:2003**  
Certifikát je platný pro následující rozsah činnosti a služeb:  
Návrh, vývoj, výroba, nákup, servis a prodej zdravotnických prostředků pro chirurgii, ortopedii, traumatologii a stomatology.  
Datum původní certifikace: 4. června 2005  
Místo a datum systematického auditu: Havík, 17. června 2011  
Za akreditovanou stranu: DET NORSKE VERITAS CERTIFICATION AS, NORWAY  
Auditor: Axel Loken Eiklid  
Evangelos Tavantzis  
Podatel auditor

**DNV**  
**DET NORSKE VERITAS**  
**CERTIFIKÁT SYSTÉMU ŘÍZENÍ**  
Certifikát č. 98706-2011-AQ-CZS-NA  
Tímto se potvrzuje, že systém řízení ve společnosti  
**MEDIN**  
**MEDIN, a.s.**  
Vlachovická 619, 592 31 Nové Město na Moravě, Česká republika  
byl shledán shodným s požadavky normy dle:  
**ISO 9001:2008**  
Certifikát je platný pro následující rozsah činnosti a služeb:  
Návrh, vývoj, výroba a prodej technických fréz, diamantových kotoučů a zpracování materiálů.  
Datum původní certifikace: 2. května 2005  
Místo a datum systematického auditu: Havík, 17. června 2011  
Za akreditovanou stranu: DET NORSKE VERITAS CERTIFICATION AS, NORWAY  
Auditor: Axel Loken Eiklid  
Evangelos Tavantzis  
Podatel auditor

**DNV**  
**DET NORSKE VERITAS**  
**CERTIFIKÁT SYSTÉMU ŘÍZENÍ**  
Certifikát č. 97607-2011-AE-CZS-RvA  
Tímto se potvrzuje, že systém řízení ve společnosti  
**MEDIN**  
**MEDIN, a.s.**  
Vlachovická 619, 592 31 Nové Město na Moravě, Česká republika  
byl shledán shodným s požadavky normy dle:  
**ISO 14001:2004**  
Certifikát je platný pro následující rozsah činnosti a služeb:  
Návrh, vývoj, výroba, nákup, servis a prodej zdravotnických prostředků pro chirurgii, ortopedii, traumatologii a stomatology. Návrh, vývoj, výroba a prodej technických fréz, diamantových kotoučů a zpracování materiálů.  
Datum původní certifikace: 14. července 2008  
Místo a datum systematického auditu: Praha, 20. května 2011  
Za akreditovanou stranu: DET NORSKE VERITAS CERTIFICATION B.V., THE NETHERLANDS  
Auditor: Jaroslav Maslowski  
Podatel auditor  
Tomas Urban  
Podatel auditor

# From tooth drills to top-class traumatology implants – the story of MEDIN

Nowadays MEDIN is a company which exports its products to dozens of countries across the world. Who and what is behind their success over the past 60 years?

## Launch of production

On 29<sup>th</sup> August 1948 in Nové Město na Moravě the foundation stone of the Chirana company was laid down. As such the future of one of the leading companies in the Czech Republic was set in motion. In 1949 came the launch tooth drill and laboratory cutters manufacturing. The former constructor, Chirana Brno, Mr Oldřich Truksa was made the first director of the emerging plant located in Nové Město.

Already back in 1956 Chirana started contributing to development tasks alongside doctors ensuing from **development in medical science and new operational procedures**. One of the first tasks focused on researching tools for vascular, chest and heart surgery, during which clamps for vessels, heart and vascular scissors as well as others were designed. Subsequent projects dealt with the locomotor apparatus (screws for joining stem femoral fractures etc.) as well as testing materials for osteopathic aids and joint replacements (shoulder, elbow and knee joints, the hip). The development and manufacturing of tools for neuro-surgery as well as plastic and eye surgery continued.



In 1957 the company grew by means of incorporation with Diamantrob, a company dealing with the **patent-protected manufacturing of diamant tools** for dentists. The history of manufacturing these tools in the original Berlin-based plant dates back to 1926–1950. Other companies which Chirana acquired under its management were Pelc-Tyrolka and Koutný, producing **special instruments for surgery**.

Due to the specific manufacturing programme and the high proportion of precise manual work



required, it always took new employees at least half a year before they acquired the basic “knack” and skill for the job in hand. For this reason at the start of the 50’s, a new vocational college was set up focusing on surgical mechanics.

The first foreign countries Chirana exported its products to were Bulgaria, Romania and Germany in 1950. In 1958 Chirana took part in a world exhibition taking place in Brussels and came away with a silver medal for its range of eye instruments. The following year Chirana Nové Město obtained 3<sup>rd</sup> grade recognition at an exhibition in Moscow.

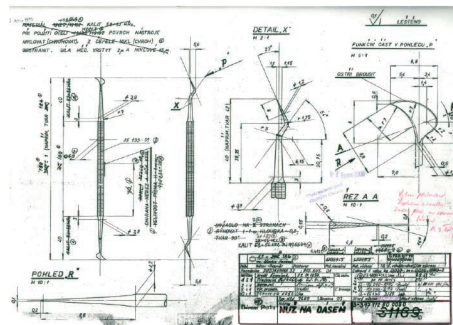

## Building the company

Chirana Nové Město holding was established in 1968.

During the 70’s an attempt to expand production prevailed which was reflected, among others, in the number of drills manufactured – at the start of the 70’s, 5 million pieces and at the end of the 80’s already 9 million pieces. Due to its continuous programme and monopoly position on the market, the company was able to manufacture **over 4 thousand types of surgical instruments**, in other words, an amount which came close to worldwide needs.

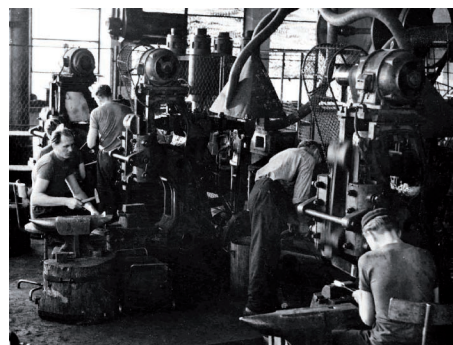

**Single purpose machines were a speciality of the plant**, with the company producing these itself in the rationalisation group department for technical development.

The newly emerging field of plastic materials in the 70’s was also accompanied by innovation in the manufacturing of instruments. Resulting from this project came scalpels with plastic holders as well as test-tubes and contraceptive coils.

In 1970 cooperation with leading hospital facilities also began to develop. In 1972 Gotfrýd MD from the Faculty Hospital in Brno put in a request for several machines and equipment to be repaired. The outcome of this was modification in

terms of the geometry for milling machine blades for drilling into the cranium thanks to which it was possible to curtail the required operating time by 30 minutes. **A number of instruments were patented for this unique solution** and the same applied for equipment and implants – for instance equipment for compressing hinges on surgical instruments cold drawn or on a nail for joining stem femoral fractures.

The Chirana company succeeded in establishing longstanding cooperation with the Union-wide Science – Research and Trial Institute of Medical Technology in Moscow. The cooperation incorporated a manufacturing project for selected dental and surgical instruments made from titanium (until this time stainless steel had been the norm) as well as a solution using diffuse chroming from carbon steel technology and corrosive resistance of medical instruments.

The products were **assessed strictly and qualitatively** in accordance with foreign (western) products, according to prototype tests as well as in a trial institute in Brno plus on the basis of opponent appraisals from medical centres.

## Privatisation

On the basis of privatisation project Nr 2815, on 24<sup>th</sup> March 1992, the Economic Board for the government of the Czech Republic approved the transformation of state company Chirana Nové Město. **As such the company name, MEDIN** comes to light, created by 154 company employees.



The 90’s are characterised by strong expansion developments and the manufacturing of traumatological implants. In 2006 MEDIN, now a Public Limited Company, purchases WALTER Medica (successor to Medical Department of the well-known aircraft engines producer WALTER) and as such enters the world of quality orthopaedic implants.

**These days MEDIN ranks as a modern Czech company with first-rate human potential and furnished with many years of know-how in the manufacturing of medical implants and instruments.**



# What is the added value we offer with our products?



During processing, each instrument or implant passes through the hands of a number of people and takes up to several hours to produce. As such it carries a part of our philosophy and basic principles with it.

## Customer

Our end customers are doctors and nurses from the fields of surgery, traumatology, orthopaedics and stomatology. We try to ensure that the solutions we deliver to customers match their needs as closely as possible.

### Testing of new instrumentaria



### Tests on product hardness

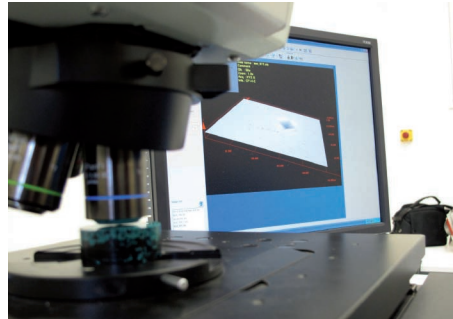

### Useful product value

Throughout the journey of making a product, from actual development right up until distribution, there is only one goal – to provide doctors with a quality instrument which will facilitate the operation procedure and assist them in their own work.

## Our surroundings

We are aware that all human activity is accompanied by changes in our environment. For this reason we have put in place a system of environmental management called EMS. As part of our Plan – Do – Check – Act Cycle model, we are constantly exploring individual processes in the company and looking for options which demonstrate greater consideration to the environment.

Our head offices are located in Nové Město na Moravě, venue of sporting events



## Company profile

MEDIN is a leading Czech manufacturer of medical instruments and implants. The four core product categories for the company are surgery, traumatology, orthopaedics and dentistry.

Established  
1949 – Chirana

Head offices  
Nové Město na Moravě

Turnover 2011  
CZK 300 mil.

Certificates  
ISO 13485, ISO 9001, ISO 14001, CE

## Sales

### Sales within products families:

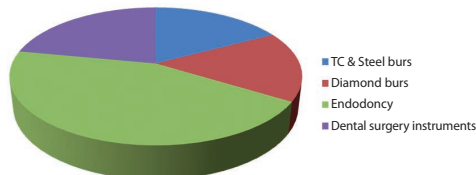

### Sales within individual export territories:

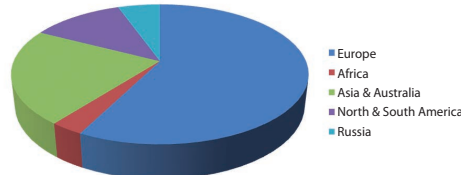

### Share of product groups in terms of overall turnover:

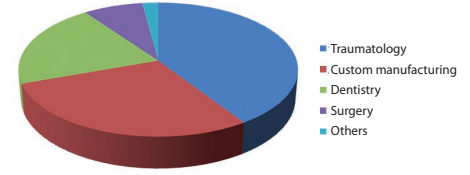

## Certificates



<b>A</b>	<b>Extrakce a chirurgie</b>	Extraction and Surgery	9–70
<b>B</b>	<b>Diagnostika</b>	Diagnostics	71–76
<b>C</b>	<b>Záchovná stomatologie</b>	Restorative	77–98
<b>D</b>	<b>Parodontologie</b>	Periodontia	99–112
<b>E</b>	<b>Ortodoncie</b>	Orthodontics	113–118
<b>F</b>	<b>Laboratoř</b>	Laboratory	119–134
<b>G</b>	<b>Sterilizace a pomocné vybavení</b>	Sterilization and Accessories	135–148
	<b>Číselný rejstřík</b>	Numerical Index	149–168
	<b>Jmenný rejstřík</b>	Alphabetical Index	169–174



A

**EXTRAKCE A CHIRURGIE**  
**EXTRACTION AND SURGERY**



<b>Kleště extrakční</b>	Extraction Forceps	11–15
<b>Kleště štípací</b>	Bone Rongeurs	16–18
<b>Kleště úchopné</b>	Grasping Forceps	19
<b>Páčidla</b>	Elevators	20
<b>Páky extrakční</b>	Root Elevators	21–25
<b>Škrabky</b>	Raspatories	26
<b>Pilníky</b>	Rasps	27
<b>Dláta</b>	Chisels	28–29
<b>Kladívka</b>	Mallets	30
<b>Háky</b>	Hooks, Retractors	31–36
<b>Chrániče prstu</b>	Finger Protectors	36
<b>Rozvěrače úst</b>	Mouth Retractors	37
<b>Lžičky</b>	Bone Curettes, Spoons	38–40
<b>Nástroje řezné</b>	Cutting Instruments	40–41
<b>Držátka skalpelových čepelí</b>	Scalpel Handles	42
<b>Skalpelové čepelky</b>	Scalpel Blades	43
<b>Svorky</b>	Clamps, Forceps	44–49
<b>Jehelce</b>	Needle Holders	50–53
<b>Zavaděče</b>	Introducers	54
<b>Dlahy dentální</b>	Dental Plates	54
<b>Nůžky</b>	Scissors	55–63
<b>Pinzety</b>	Forceps	64–70

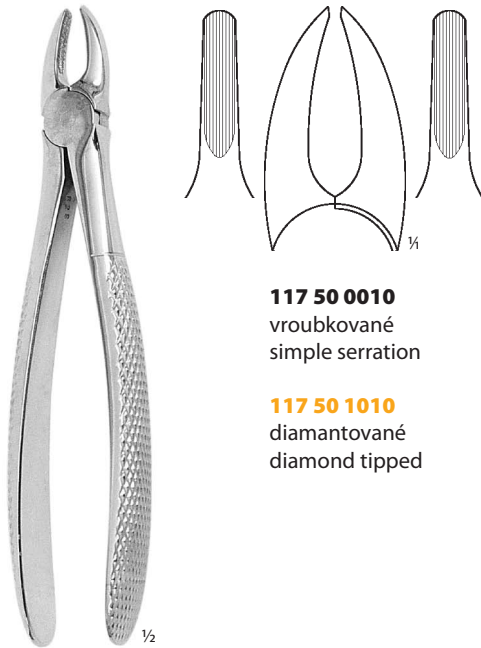

**117 50 0010**  
vroubkované  
simple serration

**117 50 1010**  
diamantované  
diamond tipped

**D2**  
na horní malé řezáky  
for upper laterals  
16,8 cm



**117 50 0020**  
vroubkované  
simple serration

**117 50 1020**  
diamantované  
diamond tipped

**D7**  
na horní premoláry  
for upper premolars  
16,4 cm



**117 50 0150**  
vroubkované  
simple serration

**117 50 1150**  
diamantované  
diamond tipped

**D13**  
na dolní premoláry  
for lower premolars  
15,0 cm



**117 50 0030**  
vroubkované  
simple serration

**117 50 1030**  
diamantované  
diamond tipped

**D17**  
na horní moláry pravé  
for right upper molars  
17,2 cm



**D18**  
na horní moláry levé  
for left upper molars  
17,2 cm

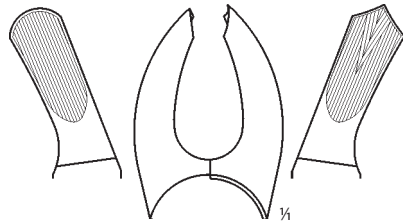

**117 50 0040**  
vroubkované  
simple serration

**117 50 1040**  
diamantované  
diamond tipped



**D22**  
na dolní moláry  
for lower molars  
15,0 cm

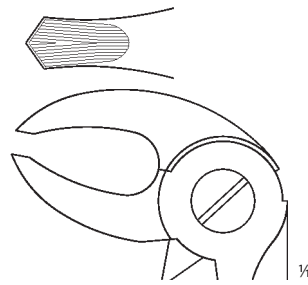

**117 50 0160**  
vroubkované  
simple serration

**117 50 1160**  
diamantované  
diamond tipped



**D30S**  
na horní kořeny  
for upper roots  
15,0 cm

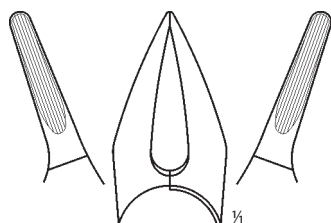

**117 50 0060**  
vroubkované  
simple serration

**117 50 1060**  
diamantované  
diamond tipped



**D33**  
na dolní kořeny široké  
for lower roots broad  
14,8 cm

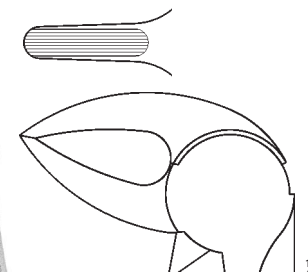

**117 50 0200**  
vroubkované  
simple serration

**117 50 1200**  
diamantované  
diamond tipped



**117 50 0190**  
vroubkované  
simple serration

**117 50 1190**  
diamantované  
diamond tipped

**D33A**  
na dolní kořeny úzké  
for lower roots  
14,8 cm

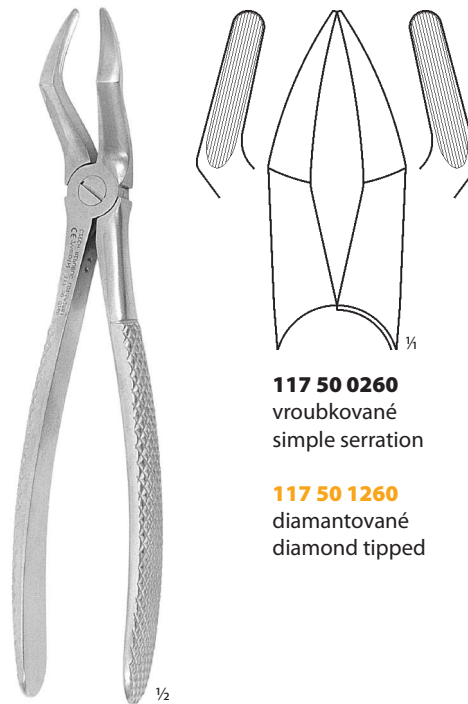

**117 50 0260**  
vroubkované  
simple serration

**117 50 1260**  
diamantované  
diamond tipped

**D51**  
bajonetové široké  
for upper roots broad  
18,2 cm

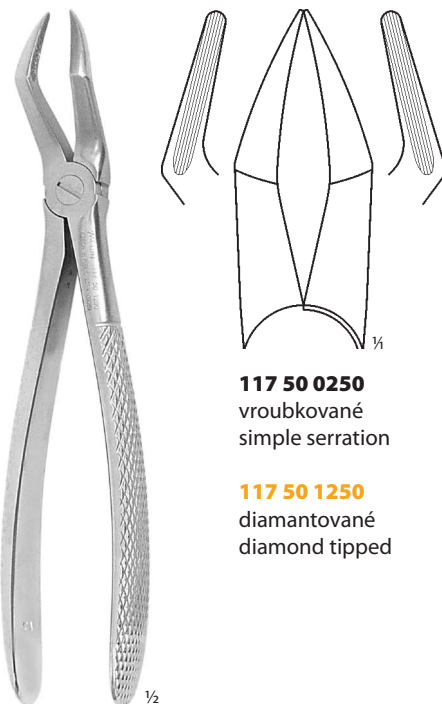

**117 50 0250**  
vroubkované  
simple serration

**117 50 1250**  
diamantované  
diamond tipped

**D51A**  
bajonetové úzké  
for upper roots narrow  
18,2 cm

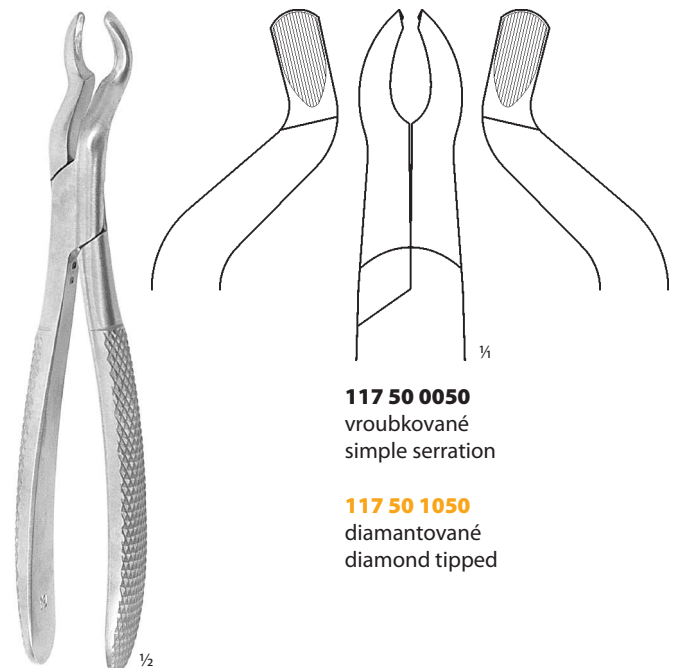

**117 50 0050**  
vroubkované  
simple serration

**117 50 1050**  
diamantované  
diamond tipped

**D67**  
na horní 3. moláry  
for upper wisdoms  
17,4 cm

KLEŠTĚ EXTRAKČNÍ  
EXTRACTION FORCEPS

**117 50 0170**  
vroubkované  
simple serration

**117 50 1170**  
diamantované  
diamond tipped

**D73**  
na dolní moláry  
for lower molars  
15,0 cm



**117 50 0350**  
vroubkované  
simple serration

**117 50 1350**  
diamantované  
diamond tipped

**D74**  
na dolní kořeny  
for lower roots  
15,0 cm

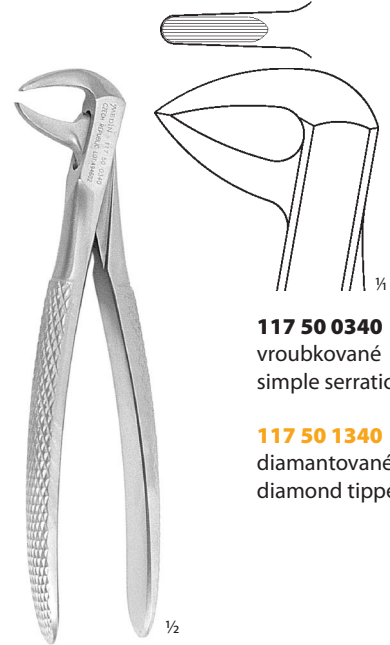

**117 50 0340**  
vroubkované  
simple serration

**117 50 1340**  
diamantované  
diamond tipped

**D74M**  
na dolní kořeny  
for lower roots  
15,0 cm



**117 50 0330**  
vroubkované  
simple serration

**117 50 1330**  
diamantované  
diamond tipped

**D74N**  
na dolní kořeny  
for lower roots  
15,0 cm

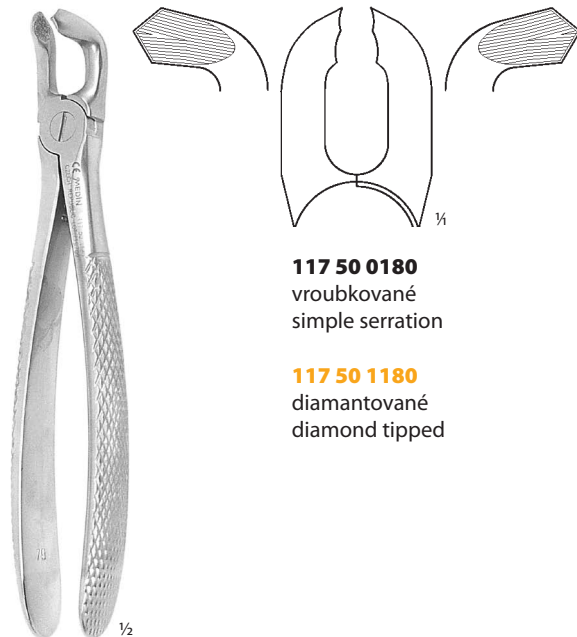

**117 50 0180**  
vroubkované  
simple serration

**117 50 1180**  
diamantované  
diamond tipped

**D79**  
na dolní 3. moláry  
for lower wisdoms  
16,5 cm



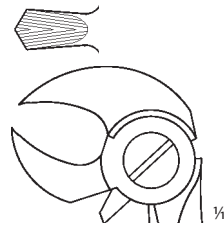

**117 50 0310**  
vroubkované  
simple serration

**117 50 1310**  
diamantované  
diamond tipped

**D339**  
na dolní moláry  
for lower molars  
10,7 cm

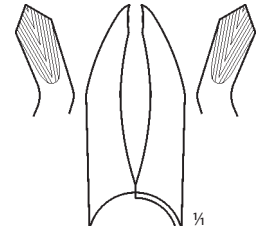

**117 50 0300**  
vroubkované  
simple serration

**117 50 1300**  
diamantované  
diamond tipped

**D342**  
na horní moláry  
for upper molars  
11,7 cm

KLEŠTĚ K ODSTRANĚNÍ KOŘENOVÝCH NÁSTROJŮ  
FORCEPS FOR EXTRACTION OF ROOT INSTRUMENTS



**117 51 0600**  
rovné  
straight  
13,5 cm



**117 51 1600**  
rovné, diamantované  
straight, diamond tipped  
13,5 cm

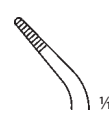

**117 51 0610**  
zahnuté  
curved  
13,5 cm

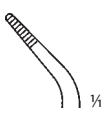

**117 51 1610**  
zahnuté, diamantované  
curved, diamond tipped  
13,5 cm

KLEŠTĚ ŠTÍPACÍ  
BONE RONGEURS

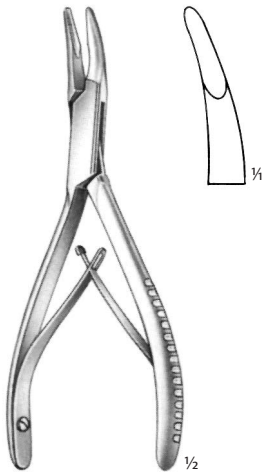

**MINI-FRIEDMAN**  
**116 91 0017**  
12,0 cm

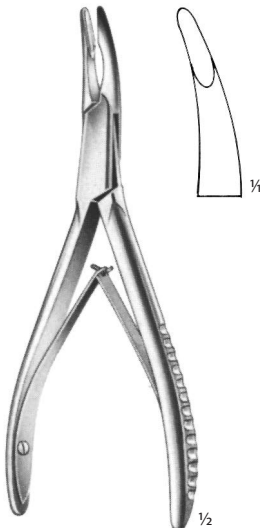

**FRIEDMAN**  
**116 91 0514**  
14,0 cm

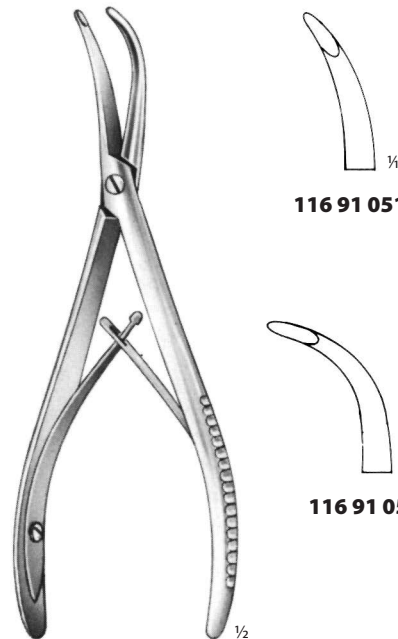

**STELLBRINK**  
17,0 cm

**116 91 0515**

**116 91 0516**

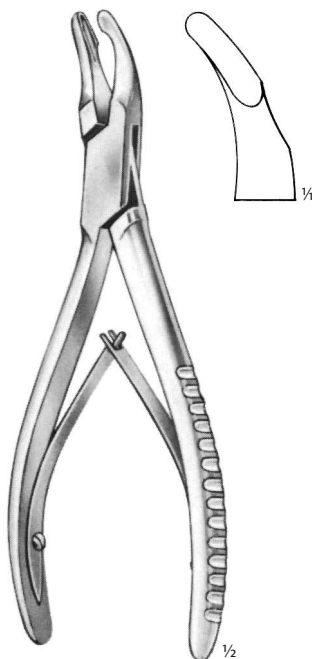

**CLEVELAND**  
**116 91 0518**  
17,0 cm

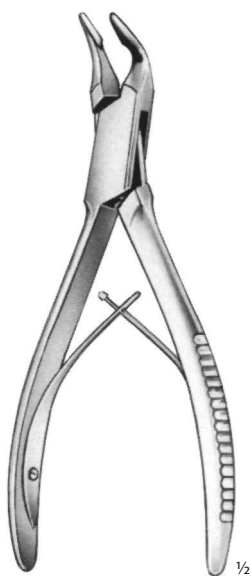

**BLUMENTHAL**  
15,5 cm

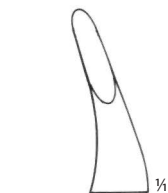

**116 91 0522**



**116 91 0523**

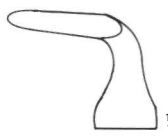

**116 91 0524**



**LUER**  
15,0 cm



**116 91 0527**

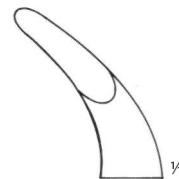

**116 91 0528**

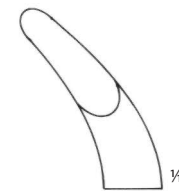

**116 91 0529**

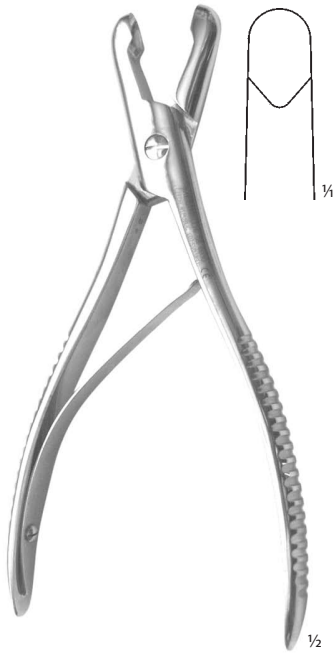

**LUER**  
**116 08 0030**  
rovné  
straight  
17,0 cm

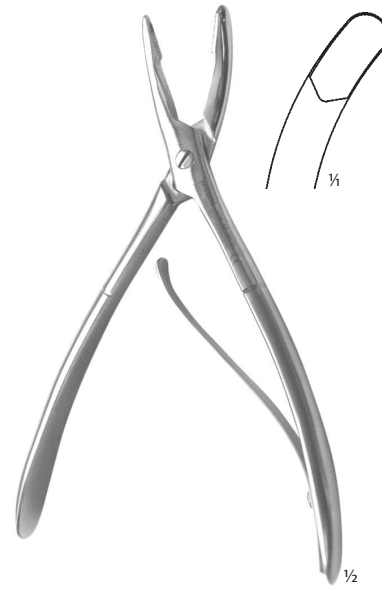

**LUER**  
**116 08 0070**  
zahnuté  
curved  
15,0 cm

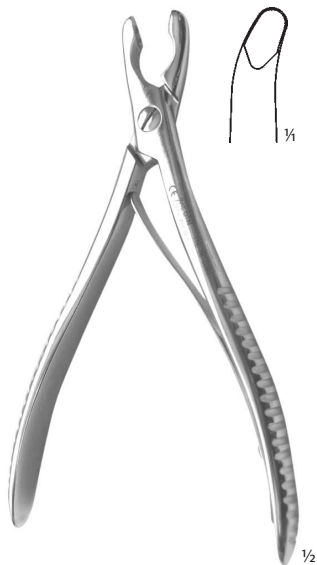

**LUER**  
**116 08 0080**  
zahnuté  
curved  
14,5 cm

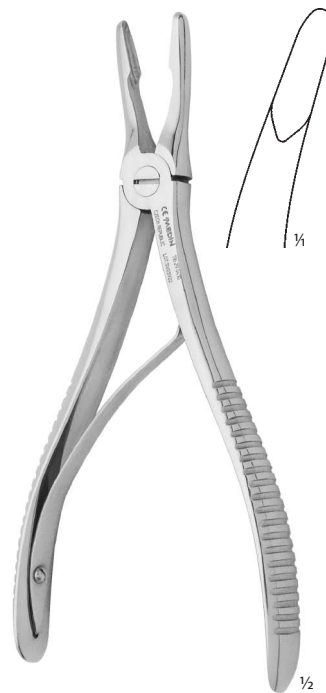

**JANSEN**  
**116 29 0410**  
zahnuté  
curved  
18,0 cm  
Fig. 2

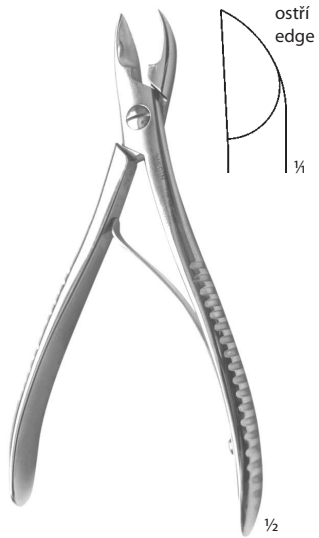

**116 08 0280**  
rovné  
straight  
14,0 cm

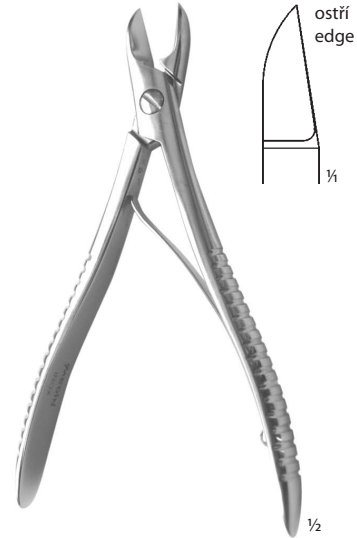

**LISTON**  
**116 08 0410**  
rovné  
straight  
14,0 cm

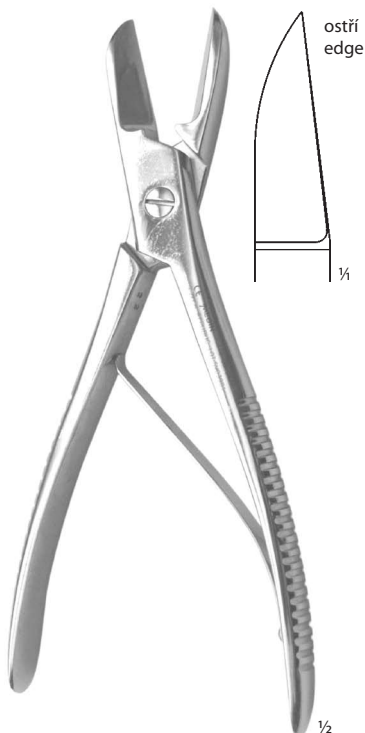

**LISTON**  
**116 08 0440**  
rovné  
straight  
19,0 cm

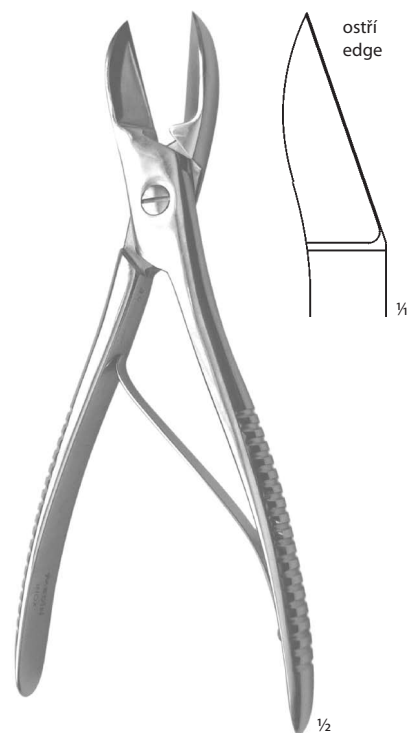

**LISTON**  
**116 08 0450**  
zahnuté  
curved  
19,0 cm

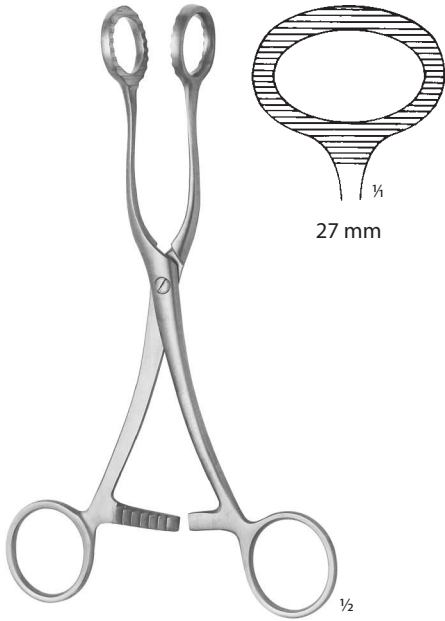

**COLLIN**  
**117 31 0010**  
16,7 cm

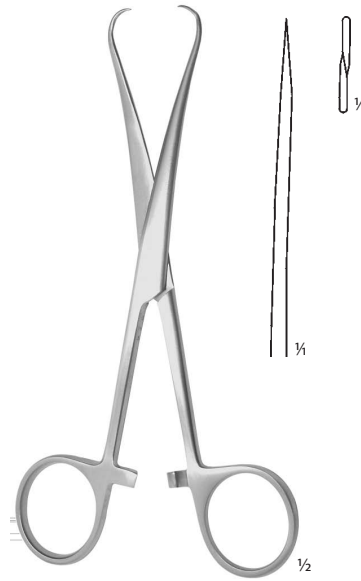

**LÖBKER**  
**117 31 0030**  
15,0 cm

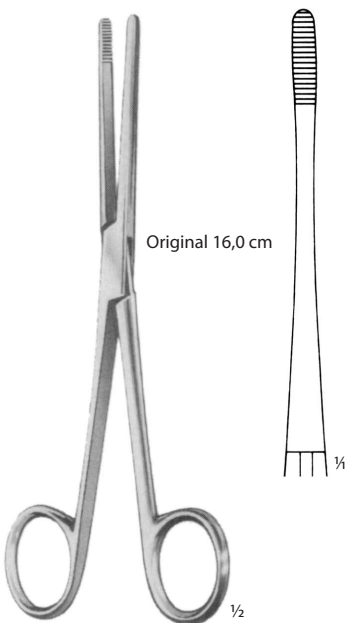

**LISTER**  
**117 91 0001** 13,0 cm  
**117 91 0002** 16,0 cm  
**117 91 0003** 18,0 cm

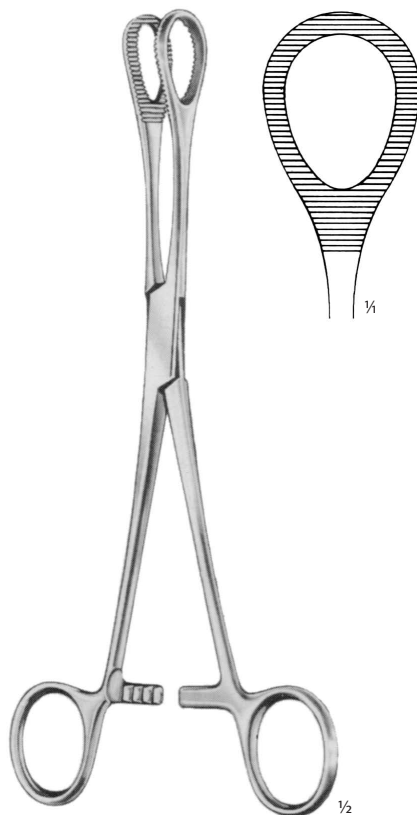

**HEYWOOD-SMITH**  
**117 91 0038**  
21,0 cm



**HEYWOOD-SMITH**  
**117 91 0039**  
25,0 cm

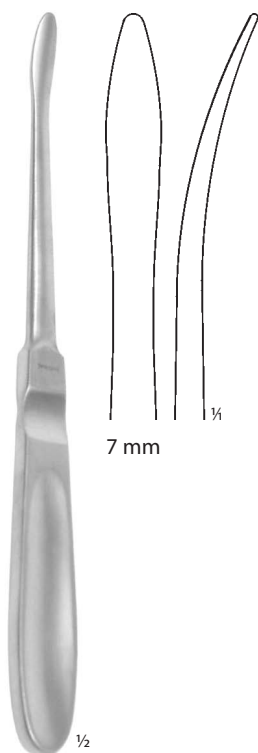

**LANGENBECK**  
**123 08 0010**  
19,5 cm  
Fig. 1

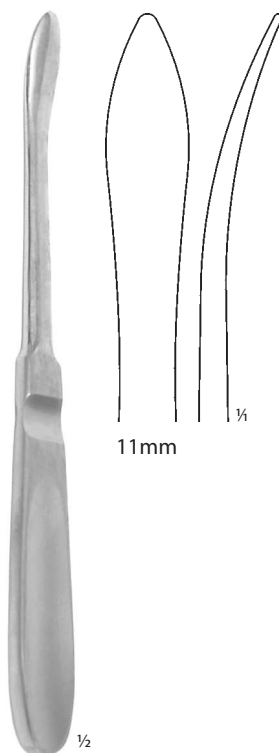

**LANGENBECK**  
**123 08 0020**  
19,5 cm  
Fig. 2

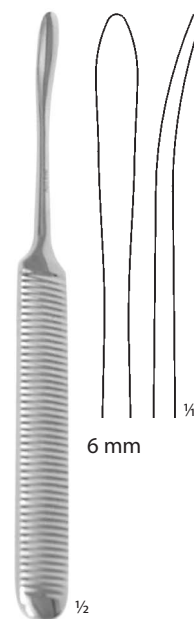

**WILLIGER**  
**123 08 0030**  
16,0 cm  
Fig. 1

PÁČIDLA NOSNÍ  
NASAL ELEVATORS

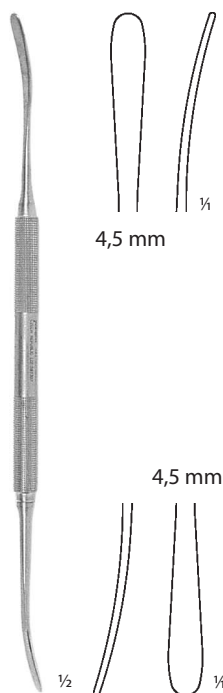

**FREER**  
**123 30 0030**  
17,9 cm

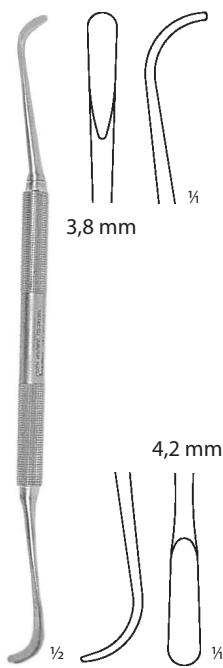

**123 99 0084**  
17,0 cm

4,5 mm

3,8 mm

4,2 mm

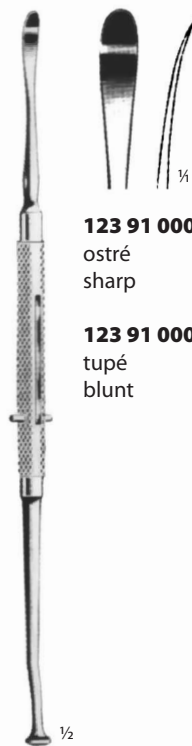

**FREER**  
19,0 cm

**123 91 0006**  
ostré  
sharp

**123 91 0007**  
tupé  
blunt

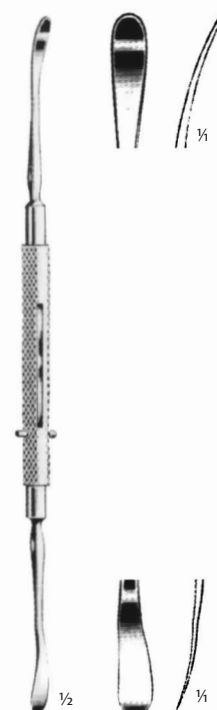

**FREER**  
**123 91 0008**  
18,0 cm

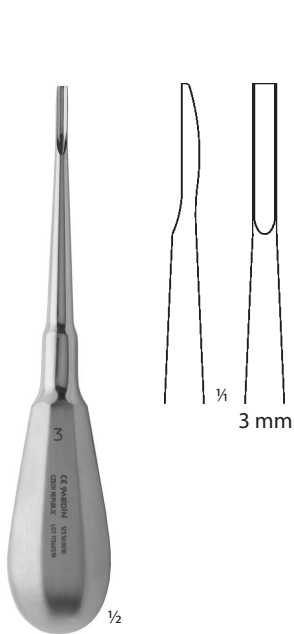

**BEIN**  
**123 50 0010**  
rovná  
straight  
14,5 cm



**BEIN**  
**123 50 0011**  
rovná  
straight  
16,5 cm

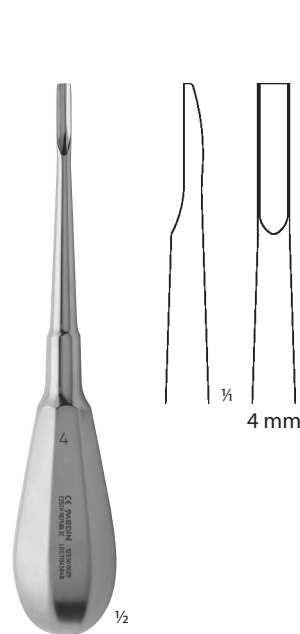

**BEIN**  
**123 50 0020**  
rovná  
straight  
14,5 cm



**BEIN**  
**123 50 0021**  
rovná  
straight  
16,5 cm

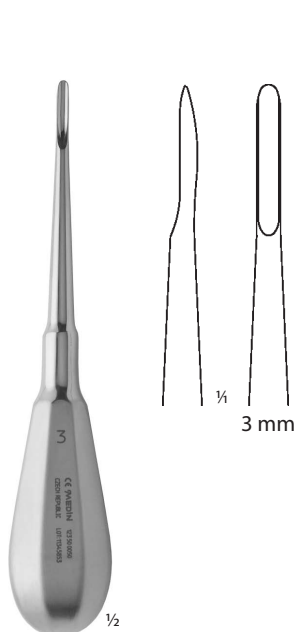

**BEIN**  
**123 50 0050**  
oblouková  
embowed  
14,5 cm



**BEIN**  
**123 50 0051**  
oblouková  
embowed  
16,5 cm

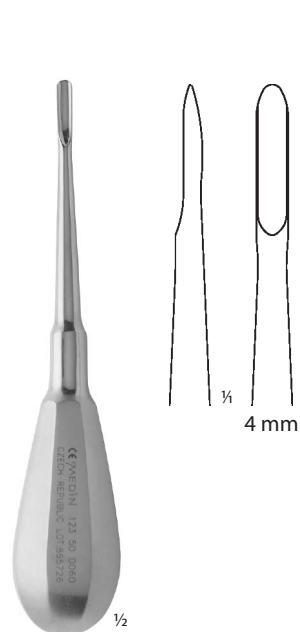

**BEIN**  
**123 50 0060**  
oblouková  
embowed  
14,5 cm

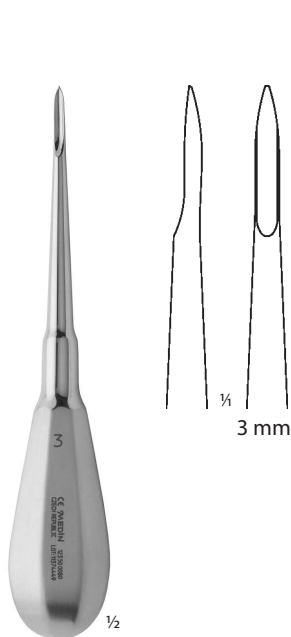

**BEIN**  
**123 50 0061**  
oblouková  
embowed  
16,5 cm

PÁKY EXTRAKČNÍ  
ROOT ELEVATORS

**BEIN**  
**123 50 0080**  
rovná, jemná  
straight, fine  
14,5 cm



**BEIN**  
**123 50 0081**  
rovná, jemná  
straight, fine  
16,5 cm

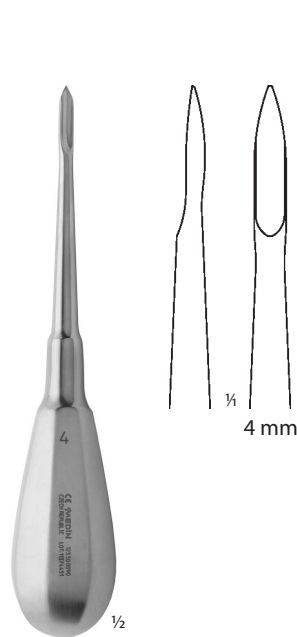

**BEIN**  
**123 50 0090**  
rovná, jemná  
straight, fine  
14,5 cm



**BEIN**  
**123 50 0091**  
rovná, jemná  
straight, fine  
16,5 cm

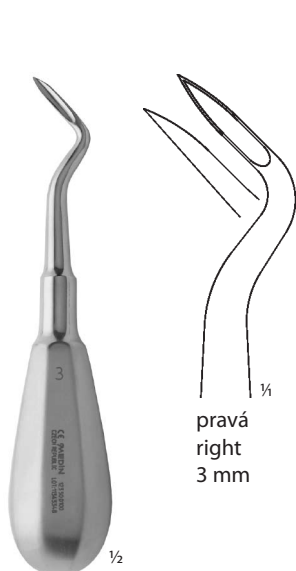

**FLOHR**  
**123 50 0100**  
hrotnatá, ostrá  
pointed, sharp  
13,0 cm



**FLOHR**  
**123 50 0101**  
hrotnatá, ostrá  
pointed, sharp  
15,0 cm

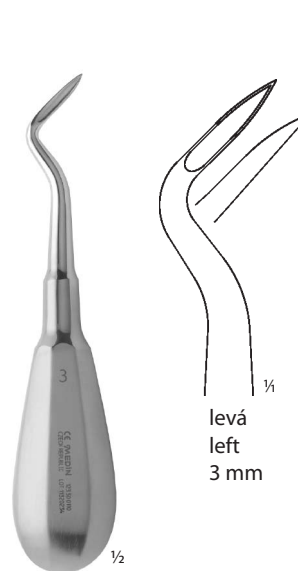

**FLOHR**  
**123 50 0110**  
hrotnatá, ostrá  
pointed, sharp  
13,0 cm



**FLOHR**  
**123 50 0111**  
hrotnatá, ostrá  
pointed, sharp  
15,0 cm



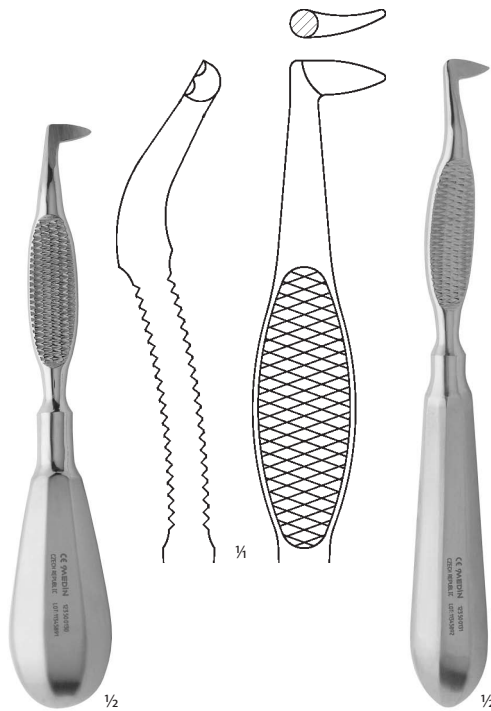

**SCHLEMMER**  
**123 50 0130**  
pravá  
right  
15,1 cm



**SCHLEMMER**  
**123 50 0131**  
pravá  
right  
17,1 cm

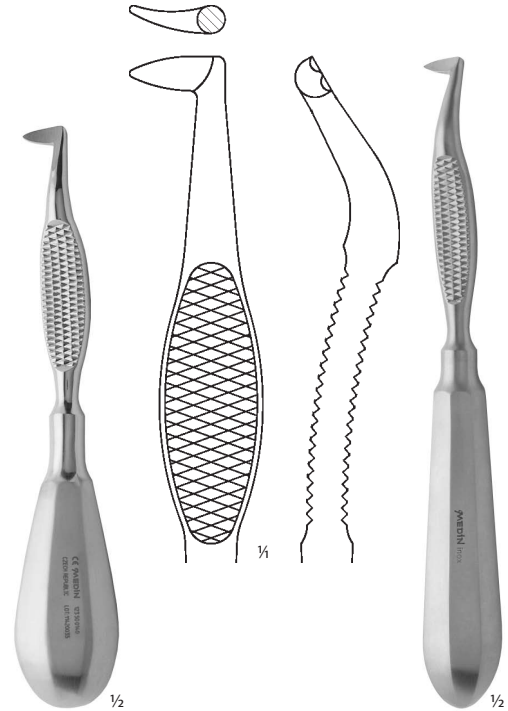

**SCHLEMMER**  
**123 50 0140**  
levá  
left  
15,1 cm



**SCHLEMMER**  
**123 50 0141**  
levá  
left  
17,1 cm

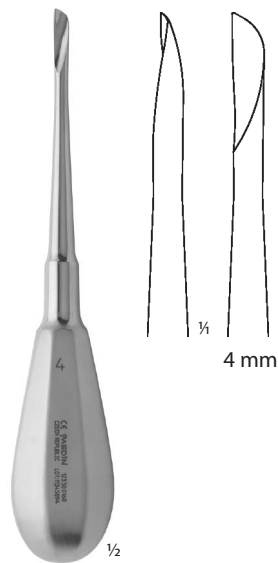

**123 50 0160**  
rovná, pravá  
straight, right  
14,5 cm

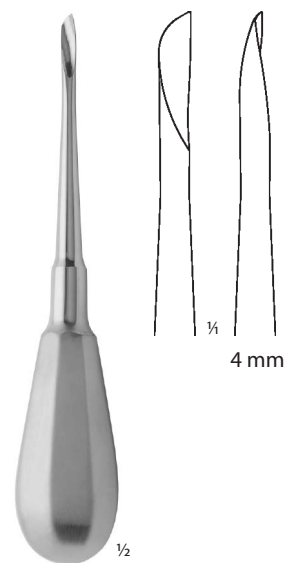

**123 50 0170**  
rovná, levá  
straight, left  
14,5 cm

PÁKY EXTRAKČNÍ  
ROOT ELEVATORS

**ŠPINAR**  
**123 50 0210**  
přední  
frontal  
14,8 cm

**ŠPINAR**  
**123 50 0211**  
přední  
frontal  
16,8 cm

**ŠPINAR**  
**123 50 0220**  
zadní  
retal  
14,8 cm

**ŠPINAR**  
**123 50 0221**  
zadní  
retal  
16,8 cm

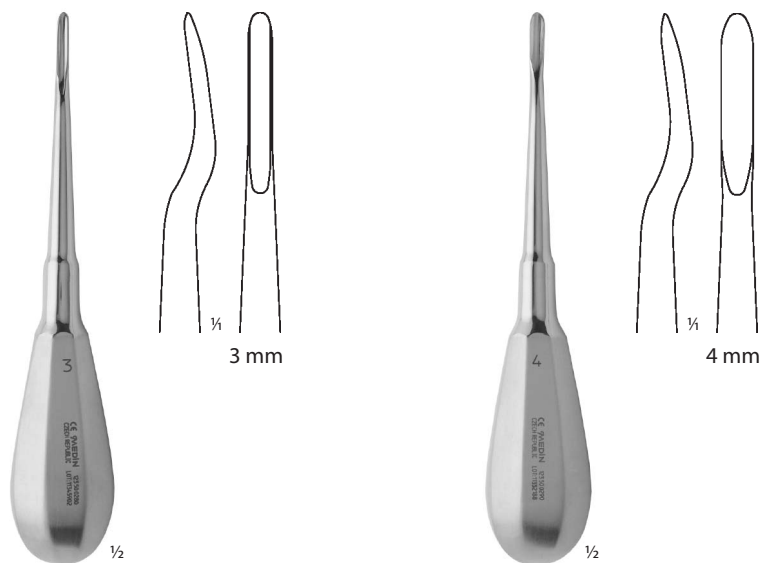

**WHITE**  
**123 50 0280**  
oblouková, vyhnutá  
embowed, angled  
14,5 cm

**WHITE**  
**123 50 0290**  
oblouková, vyhnutá  
embowed, angled  
14,5 cm

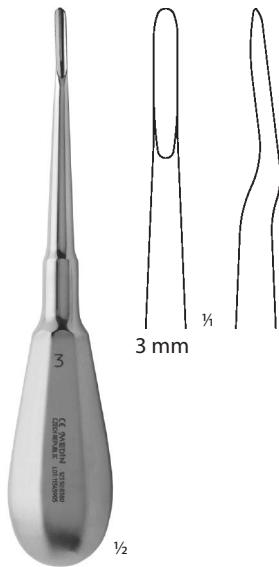

**WHITE**  
**123 50 0380**  
oblouková, vyhnutá  
embowed, angled  
14,5 cm

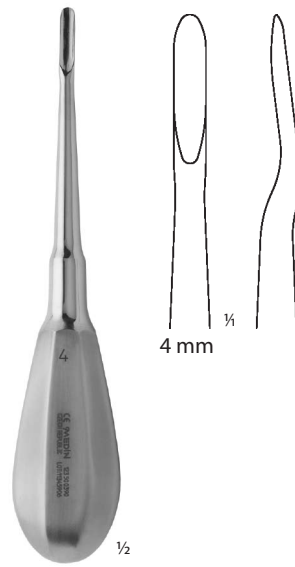

**WHITE**  
**123 50 0390**  
oblouková, vyhnutá  
embowed, angled  
14,5 cm

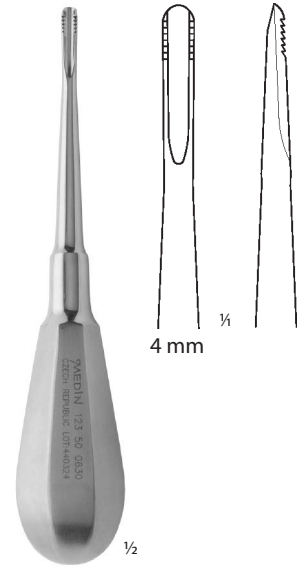

**123 50 0630**  
se zuby, rovná  
with saw, straight  
14,5 cm

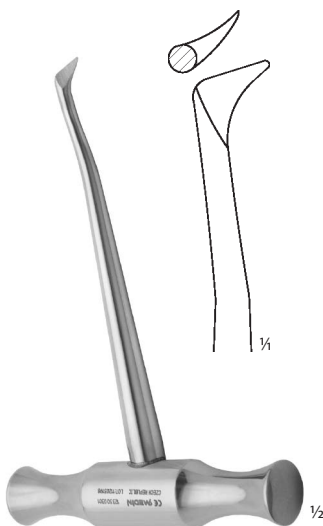

**BARRY**  
**123 50 0301**  
pravá  
right  
12,4 cm

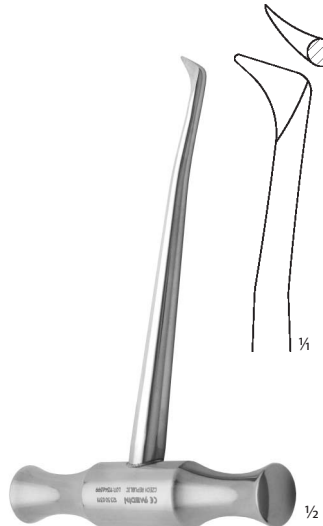

**BARRY**  
**123 50 0311**  
levá  
left  
12,4 cm

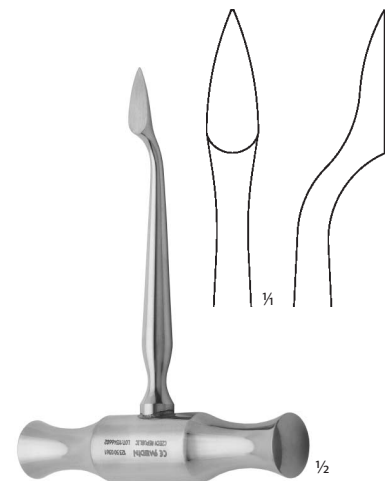

**LECLUSE**  
**123 50 0361**  
10,8 cm

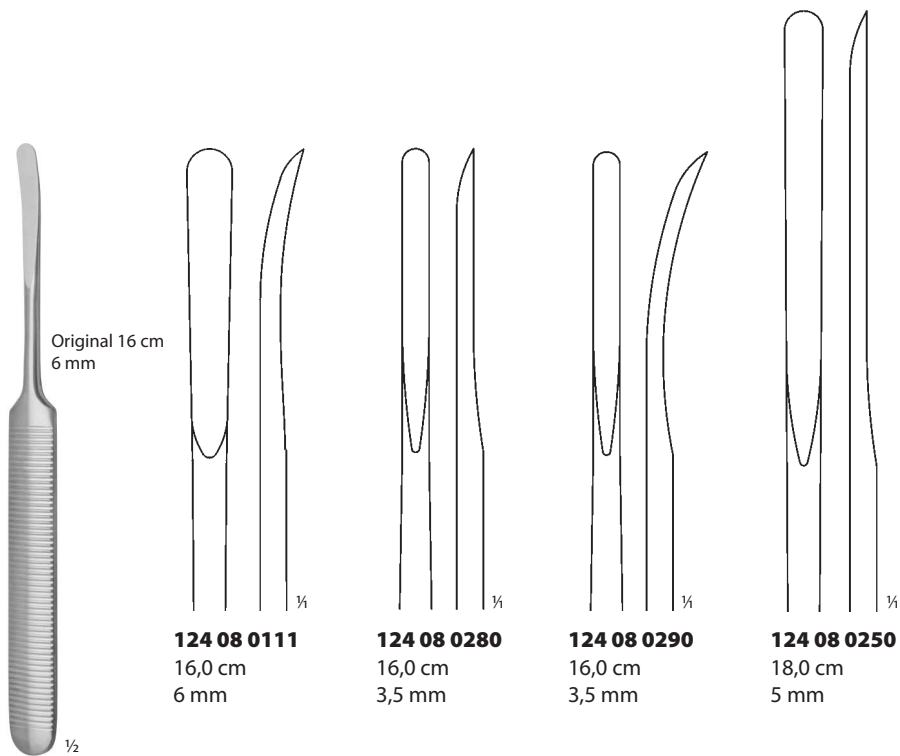

**WILLIGER**  
16,0 cm

**124 08 0111**  
16,0 cm  
6 mm

**124 08 0280**  
16,0 cm  
3,5 mm

**124 08 0290**  
16,0 cm  
3,5 mm

**124 08 0250**  
18,0 cm  
5 mm



**LANGENBECK**  
**124 08 0120**  
20,5 cm

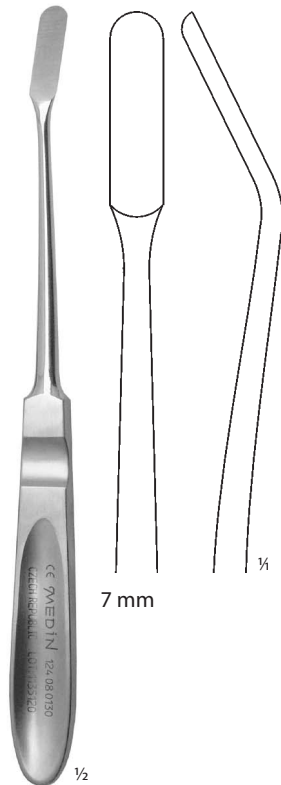

**LANGENBECK**  
**124 08 0130**  
20,4 cm

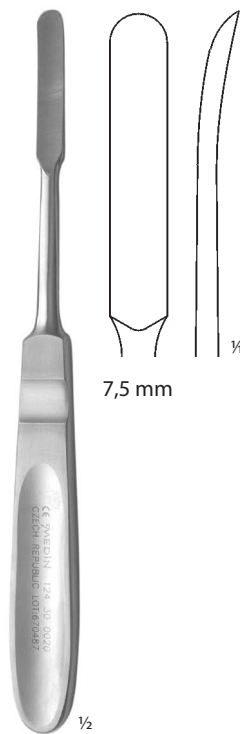

**PŘECEHTĚL**  
**124 30 0020**  
19,0 cm

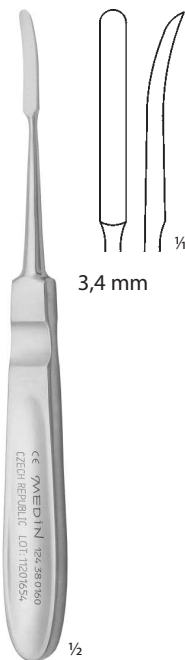

**124 38 0160**  
17,2 cm



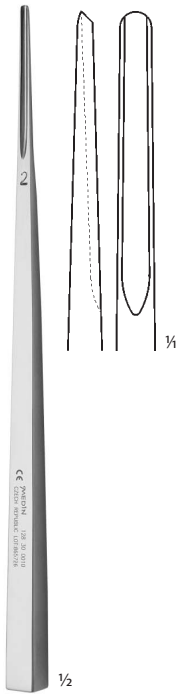

**128 30 0010**  
18,0 cm  
2 mm

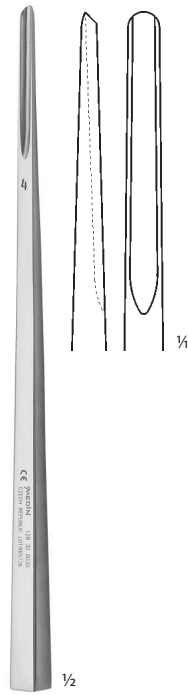

**128 30 0030**  
18,0 cm  
4 mm

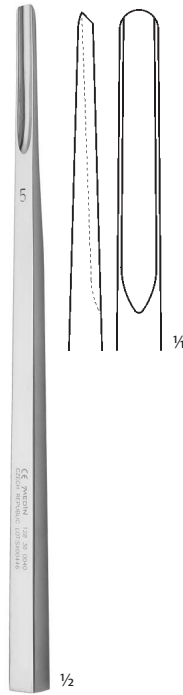

**128 30 0040**  
18,0 cm  
5 mm

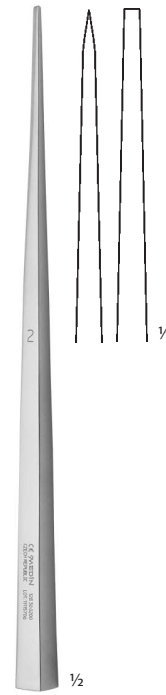

**WEST**  
**128 30 0200**  
18,0 cm  
2 mm

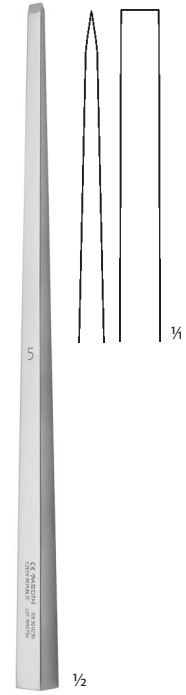

**WEST**  
**128 30 0230**  
18,0 cm  
5 mm

DLÁTA JEMNÁ  
CHISELS FINE

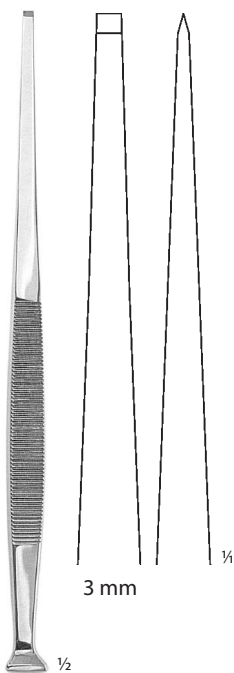

**128 50 0050**  
ploché  
flat  
17,5 cm

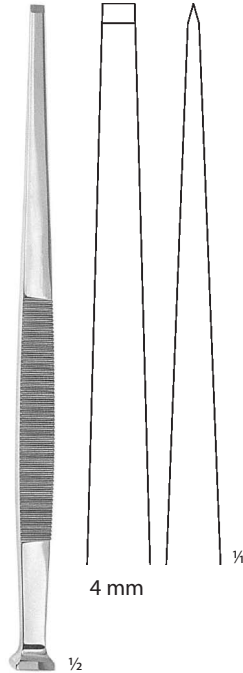

**128 50 0060**  
ploché  
flat  
17,5 cm

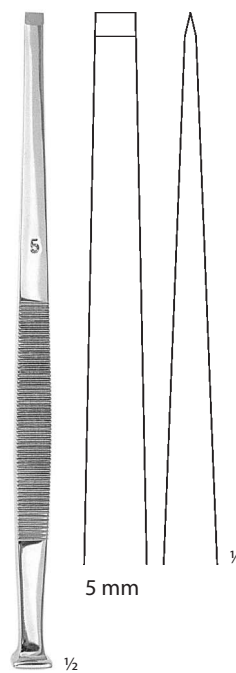

**128 50 0070**  
ploché  
flat  
17,5 cm

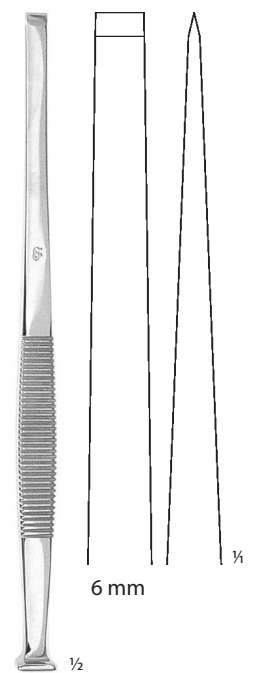

**128 50 0080**  
ploché  
flat  
17,5 cm

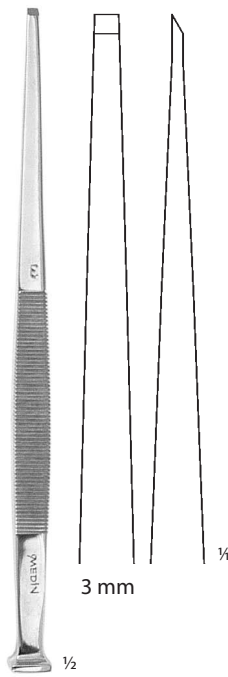

**128 50 0110**  
poloklínové  
half-wedged  
17,5 cm

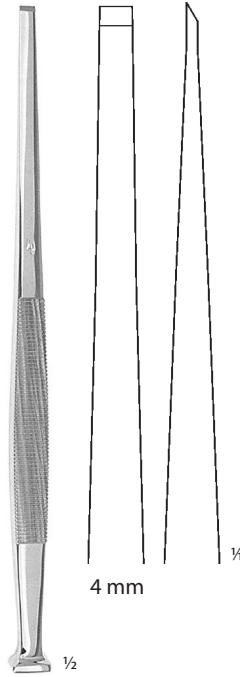

**128 50 0120**  
poloklínové  
half-wedged  
17,5 cm

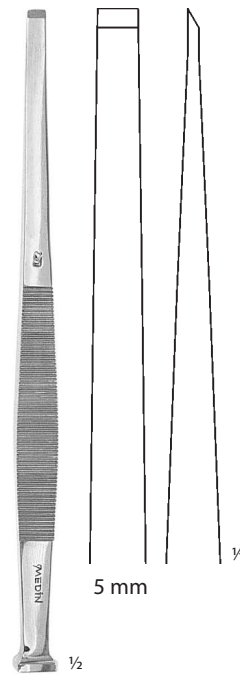

**128 50 0130**  
poloklínové  
half-wedged  
17,5 cm

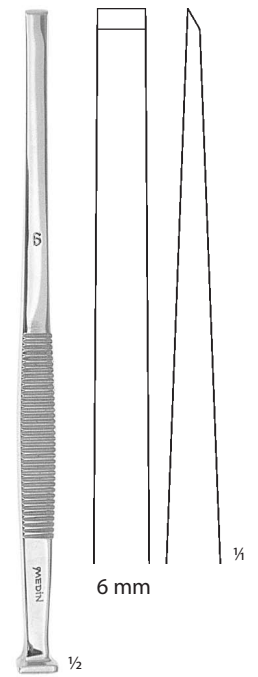

**128 50 0140**  
poloklínové  
half-wedged  
17,5 cm

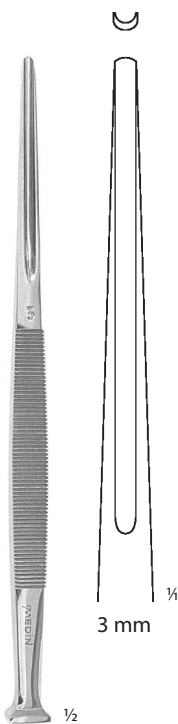

**128 50 0200**  
žlábkové  
grooved  
17,5 cm

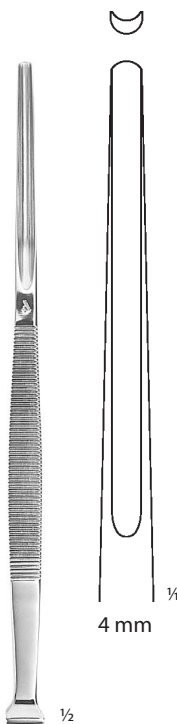

**128 50 0210**  
žlábkové  
grooved  
17,5 cm

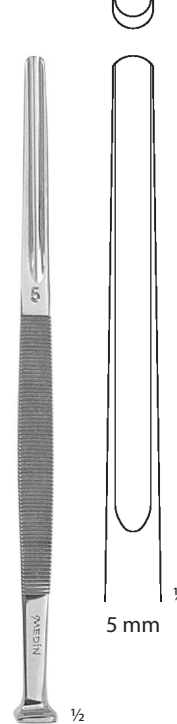

**128 50 0220**  
žlábkové  
grooved  
17,5 cm

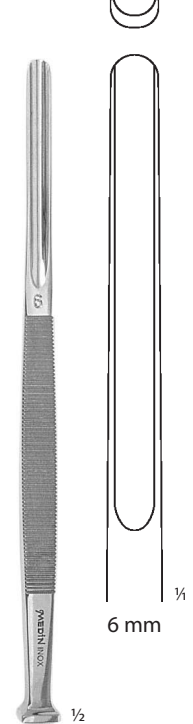

**128 50 0230**  
žlábkové  
grooved  
17,5 cm



½

Kladívko chirurgické  
Surgical mallet  
**128 08 0901**  
250 g  
22,3 cm



½

Kladívko chirurgické  
Surgical mallet  
**128 08 0911**  
500 g  
23,5 cm





**118 91 0027**  
16,0 cm



**118 08 0010**



**118 08 0050**

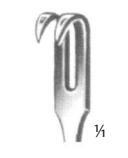

**118 08 0020**

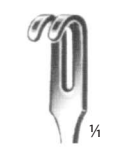

**118 08 0060**

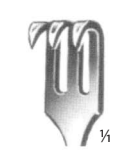

**118 91 0027**

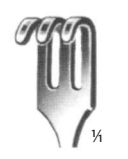

**118 91 0035**



**118 91 0028**  
ostrý  
sharp



**118 91 0036**  
tupý  
blunt



**118 91 0046**  
ohýbný  
flexible  
16,0 cm



**118 91 0045**



**118 91 0048**

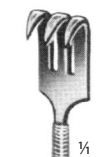

**118 91 0046**



**118 91 0049**

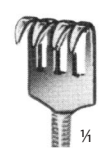

**118 91 0047**  
ostrý  
sharp

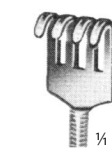

**118 91 0050**  
tupý  
blunt



**JOSEPH**  
**118 91 0051**  
16,0 cm



**JOSEPH**  
**118 91 0052**  
16,0 cm

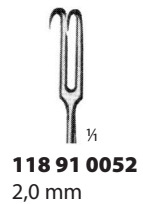

**118 91 0052**  
2,0 mm



**118 91 0053**  
5,0 mm

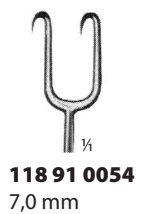

**118 91 0054**  
7,0 mm

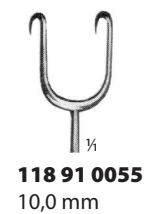

**118 91 0055**  
10,0 mm

HÁKY JEMNÉ  
DELICATE HOOKS



**DESMARRES**  
13,0 cm



**118 38 0020**  
12 mm

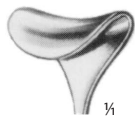

**118 91 0077**  
16 mm



**118 38 0010**  
10 mm



**118 38 0030**  
14 mm



**118 91 0078**  
18 mm

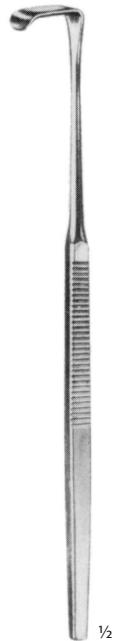

**MINI-LANGENBECK**  
16,0 cm



**118 91 0069**



**118 91 0070**



**118 91 0071**



**118 91 0072**



**CUSHING**  
20,0 cm



**118 91 0085**  
8 mm



**118 91 0087**  
12 mm

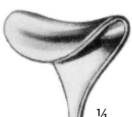

**118 91 0089**  
16 mm



**118 91 0086**  
10 mm



**118 91 0088**  
14 mm



**118 91 0090**  
18 mm

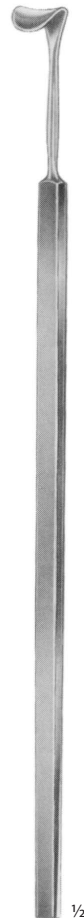

**CUSHING**  
24,0 cm



**118 91 0091**  
8 mm

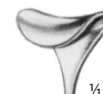

**118 91 0093**  
12 mm



**118 91 0095**  
16 mm

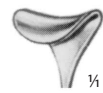

**118 91 0092**  
10 mm



**118 91 0094**  
14 mm



**118 91 0096**  
18 mm



**118 12 0010**  
16,0 cm

**118 12 0010**  
Fig. 1



**118 12 0020**  
Fig. 2



**118 12 0050**  
16,0 cm

**118 12 0050**  
5,0 mm

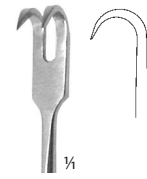
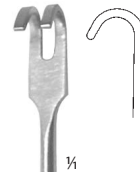

**118 12 0060**  
5,0 mm



**118 38 0210**  
13,5 cm

**118 38 0210**  
2,6 mm



**118 38 0220**  
3,2 mm

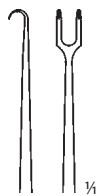

**118 38 0230**  
4,0 mm

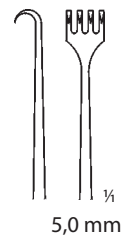
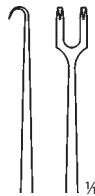

**118 38 0360**  
14,5 cm



HÁKY NA RÁNY  
RETRACTORS

**MIDDELDORPF**  
**118 08 0650**



**118 08 0650**  
14 × 12 mm  
22,0 cm



**118 08 0660**  
21 × 21 mm  
22,0 cm



**118 08 0670**  
32 × 31 mm  
23,5 cm

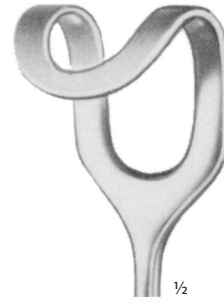

**118 08 0680**  
62 × 50 mm  
28,0 cm

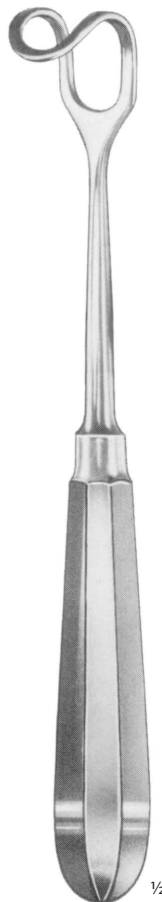

**MIDDELDORPF**  
**118 91 0208**



**118 91 0208**  
14 × 17 mm  
21,5 cm



**118 91 0209**  
20 × 22 mm  
22,0 cm

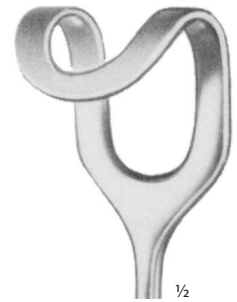

**118 91 0210**  
26 × 30 mm  
23,5 cm

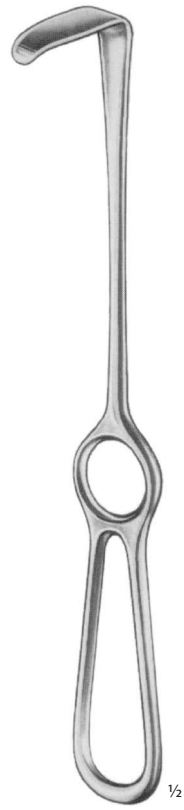

**LANGENBECK**  
21,0 cm

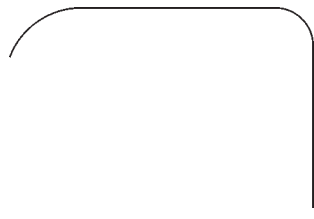

**118 08 0800**  
40 × 10 mm

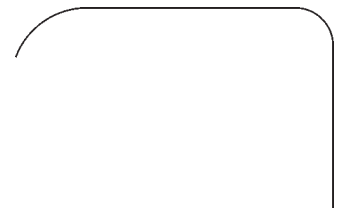

**118 08 0810**  
42 × 13 mm



**118 31 0040**  
rovný  
straight  
16,4 cm

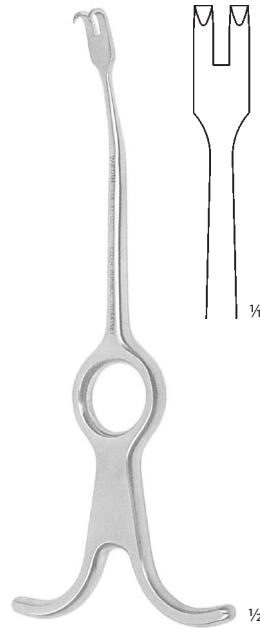

**118 31 0070**  
rovný  
straight  
16,4 cm

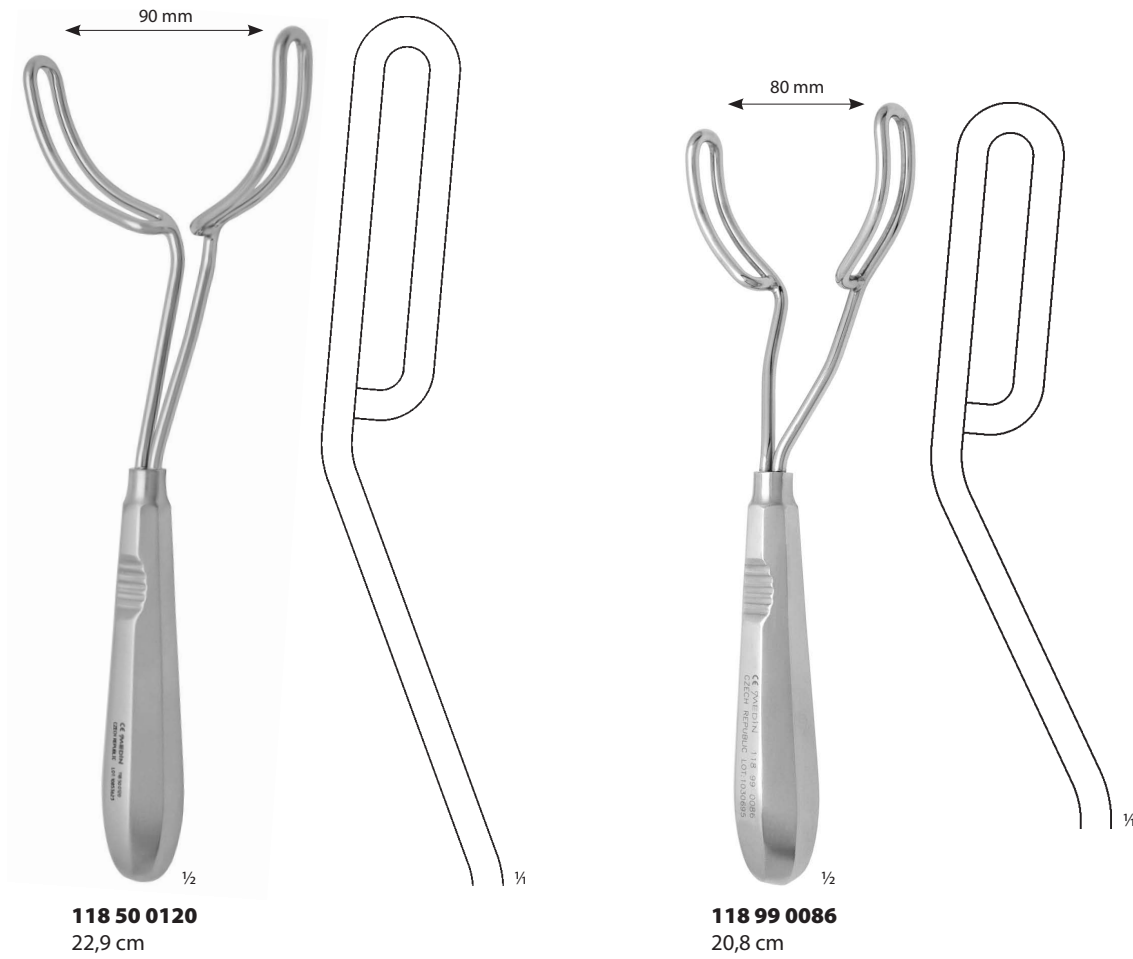
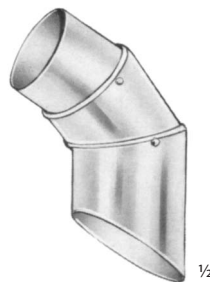
HÁK INTRAORÁLNÍ  
INTRAORAL HOOKCHRÁNIČE PRSTU  
FINGER PROTECTORS

## LANGENBECK

	Ø
136 91 0001	2,20 cm
136 91 0002	2,45 cm
136 91 0003	2,65 cm



**ROSER-KÖNIG**  
**119 07 0010**  
19,5 cm

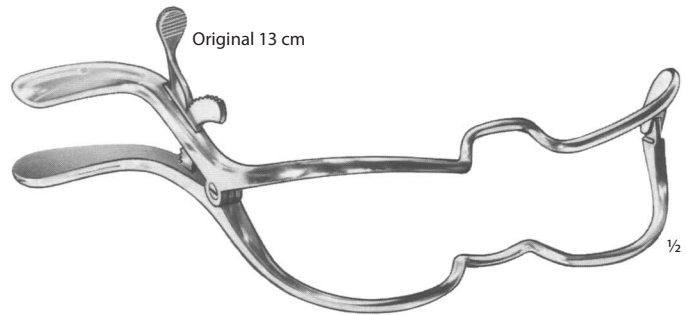

**JENNINGS**  
**119 91 0185** 9,0 cm  
**119 91 0186** 11,0 cm  
**119 91 0187** 13,0 cm  
**119 91 0188** 15,0 cm

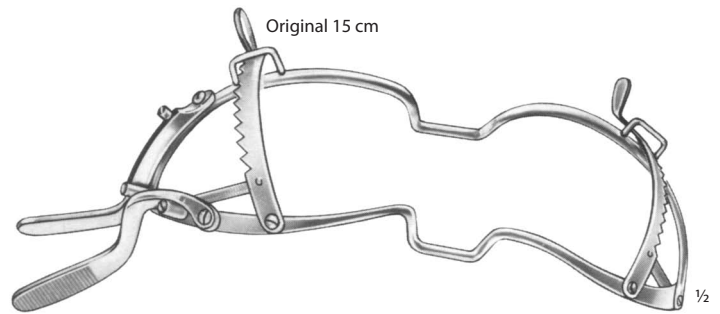

**WHITEHEAD**  
**119 91 0190** 11,0 cm  
**119 91 0191** 13,0 cm  
**119 91 0192** 15,0 cm



**HEISTER**  
**119 07 0020**  
13,0 cm

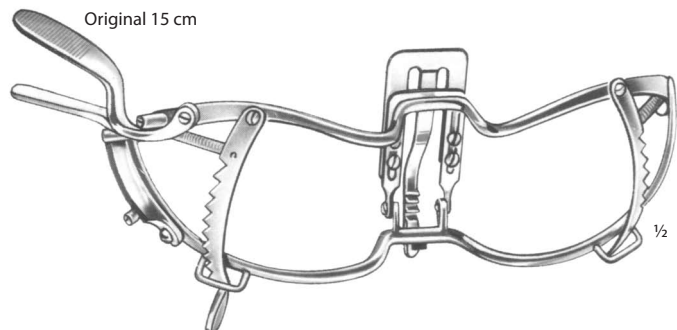

**WHITEHEAD**  
**119 91 0194** 11,0 cm  
**119 91 0195** 13,0 cm  
**119 91 0196** 15,0 cm

LŽIČKY OBOUSTRANNÉ  
BONE CURETTES DOUBLE FACED

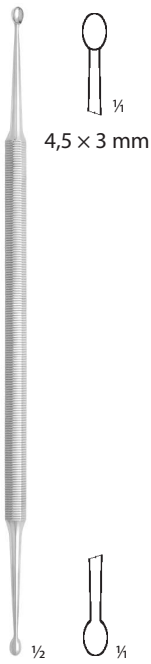

●  
**125 50 0010**  
rovná  
straight  
17,0 cm

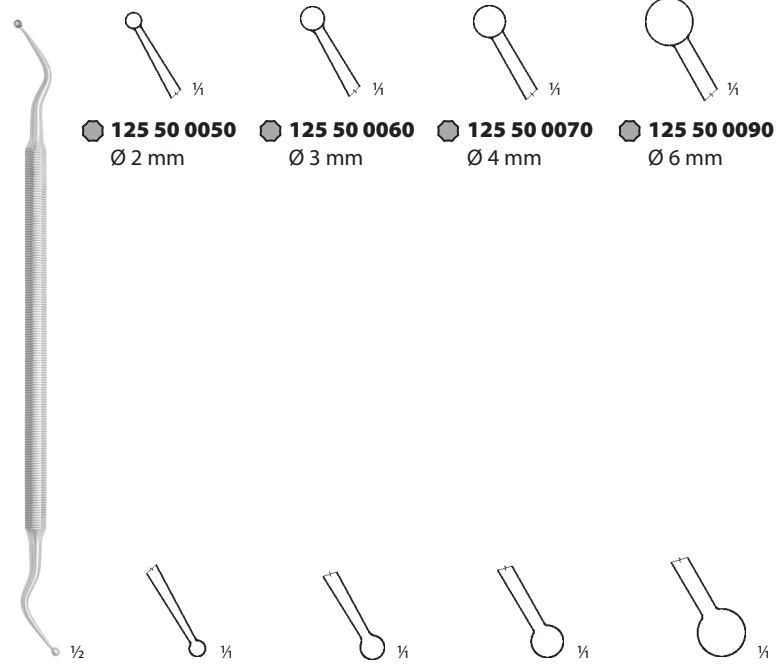

●  
**125 50 0050**  
lomená, ostrá  
angled, sharp  
17,0 cm



○  
**125 56 0066**  
lomená, ostrá  
angled, sharp  
16,7 cm

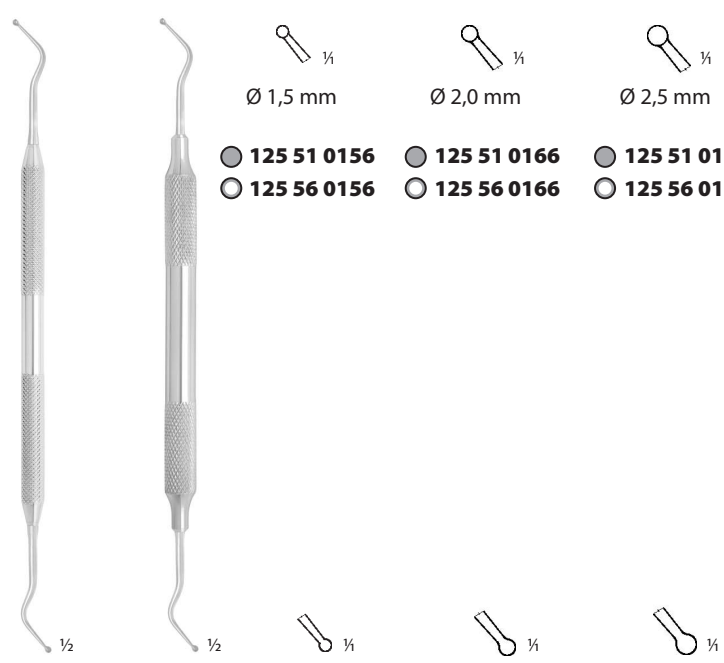

●  
**125 51 0156**  
ostrá  
sharp  
16,6 cm

○  
**125 56 0156**  
ostrá  
sharp  
16,6 cm

● osmihránné držátko – octagonal handle    5,5 mm    ○ plné držátko – round solid handle    Ø 6,0 mm    ○ duté držátko – hollow handle    Ø 8,0 mm





Original 17,0 cm



**125 08 0110**  
17,0 cm  
Fig. 000  
3,5 mm



**125 08 0120**  
17,2 cm  
Fig. 0  
4,8 mm



**125 08 0130**  
17,5 cm  
Fig. 1  
6,0 mm



**125 08 0140**  
17,7 cm  
Fig. 3  
8,5 mm



**125 08 0150**  
18,4 cm  
Fig. 5  
12,0 mm



Original 17,5 cm



**125 08 0160**  
16,5 cm  
Fig. 1  
3,0 mm



**125 08 0170**  
16,5 cm  
Fig. 2  
3,5 mm



**125 08 0180**  
17,5 cm  
Fig. 3  
4,0 mm



**125 08 0190**  
17,5 cm  
Fig. 4  
5,0 mm



**125 08 0200**  
19,5 cm  
Fig. 5  
6,0 mm



**125 08 0210**  
19,5 cm  
Fig. 6  
6,7 mm

LŽIČKY  
BONE CURETTES

**125 50 0100**  
pravá  
right  
16,3 cm

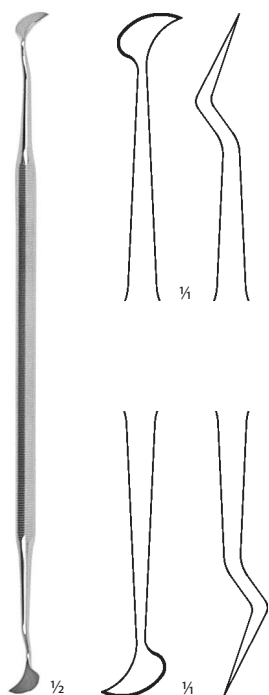

**125 50 0110**  
levá  
left  
16,3 cm

NOŽE  
KNIVES

Nůž na dásněn oboustranný  
Gum knife mutual  
**112 50 0050**  
18,0 cm

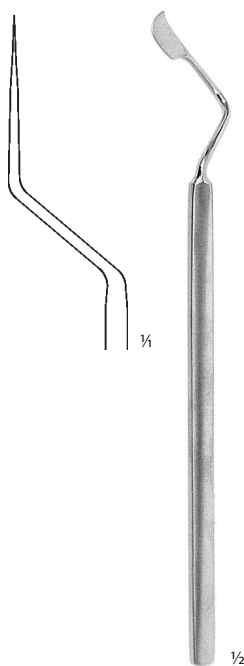

Nůž na gingivektomii  
Gingivectomy knife  
**112 50 0060**  
17,3 cm  
Fig. 1

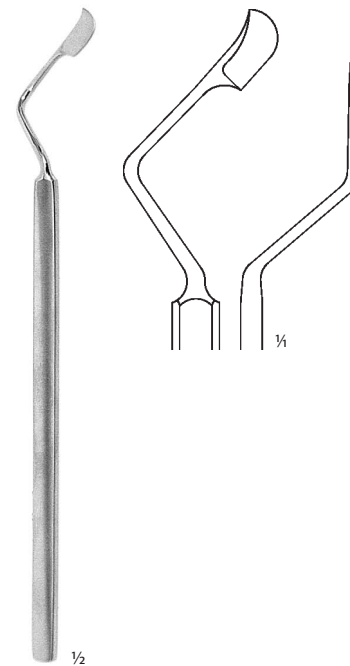

Nůž na gingivektomii  
Gingivectomy knife  
**112 50 0070**  
17,3 cm  
Fig. 2

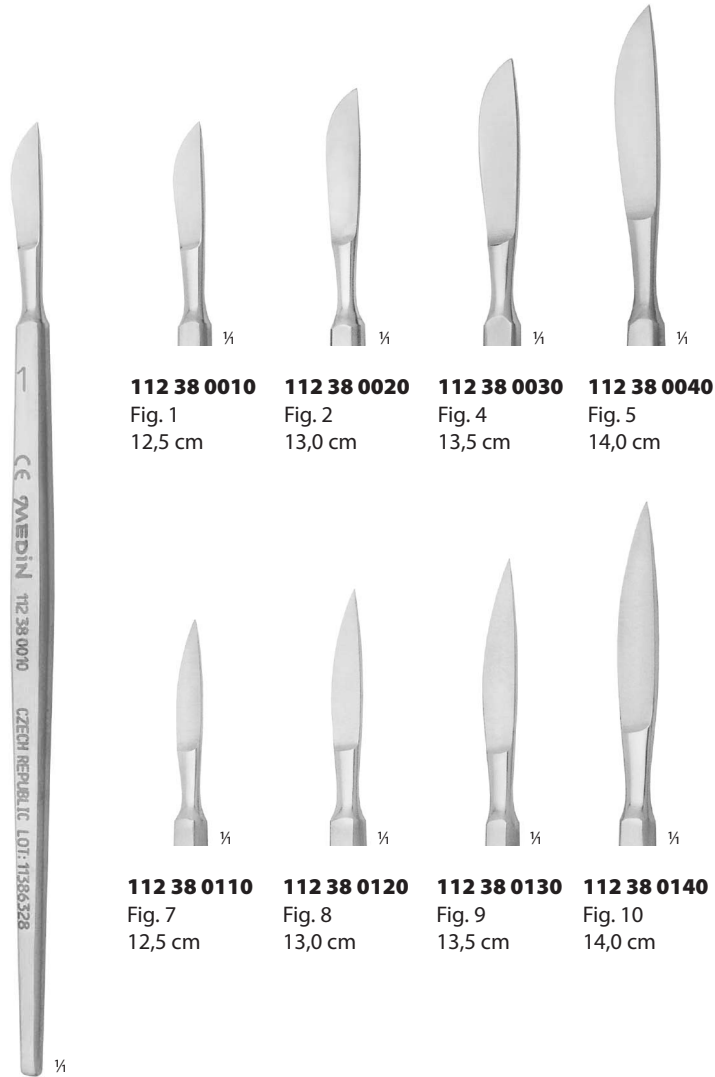

**112 38 0010**  
Fig. 1  
12,5 cm

**112 38 0020**  
Fig. 2  
13,0 cm

**112 38 0030**  
Fig. 4  
13,5 cm

**112 38 0040**  
Fig. 5  
14,0 cm

**112 38 0110**  
Fig. 7  
12,5 cm

**112 38 0120**  
Fig. 8  
13,0 cm

**112 38 0130**  
Fig. 9  
13,5 cm

**112 38 0140**  
Fig. 10  
14,0 cm

**DIEFFENBACH**  
12,5 cm

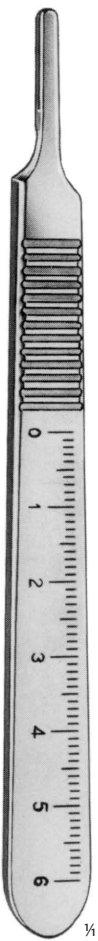

**112 91 0002**  
12,3 cm  
Fig. 3



**112 91 0003**  
12,3 cm  
Fig. 3



**112 91 0004**  
13,3 cm  
Fig. 4

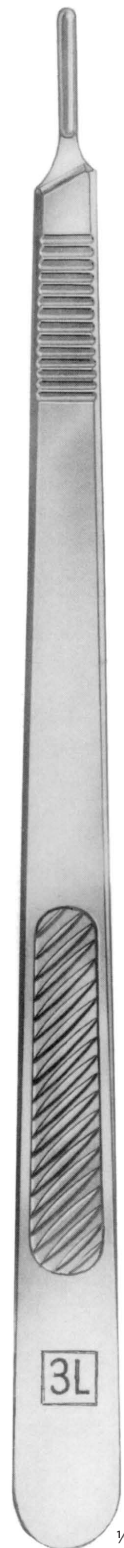

**112 91 0005**  
20,5 cm  
Fig. 3L



**112 08 0696**  
15,0 cm



Utahovací klíček  
Spanner  
**112 08 0700**  
8,0 cm

SKALPELOVÉ ČEPELKY STERILNÍ PRO VELIKOST DRŽÁTKA 3  
SCALPEL BLADES STERILE FOR HANDLE SIZE 3

pro držátka  
for handles

112 91 0002  
112 91 0003  
112 91 0005  
112 91 0007  
112 91 0008



**112 91 0010**  
Fig. 10

**112 91 0011**  
Fig. 11

**112 91 0012**  
Fig. 12

**112 91 0025**  
Fig. 12d

**112 91 0013**  
Fig. 13

**112 91 0015**  
Fig. 15

**112 91 0026**  
Fig. 15c

POZNÁMKY: sterilní, balení 100 ks  
NOTES: sterile, packing 100 pcs

SKALPELOVÉ ČEPELKY STERILNÍ PRO VELIKOST DRŽÁTKA 4  
SCALPEL BLADES STERILE FOR HANDLE SIZE 4

pro držátka  
for handles

112 91 0004  
112 91 0006  
112 08 0650

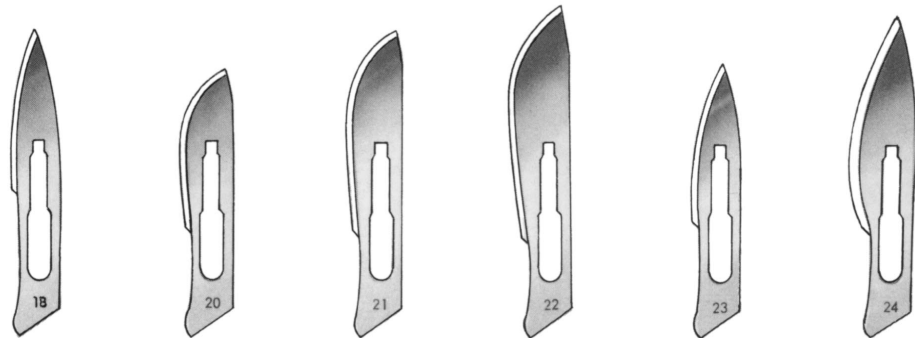

**112 91 0018**  
Fig. 18

**112 91 0020**  
Fig. 20

**112 91 0021**  
Fig. 21

**112 91 0022**  
Fig. 22

**112 91 0023**  
Fig. 23

**112 91 0024**  
Fig. 24

POZNÁMKY: sterilní, balení 100 ks  
NOTES: sterile, packing 100 pcs

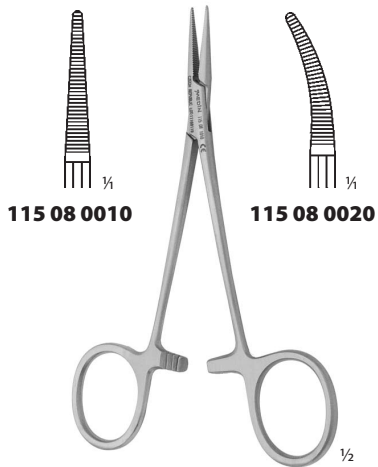
**MOSQUITO-HALSTED**

standard  
standard  
12,0 cm

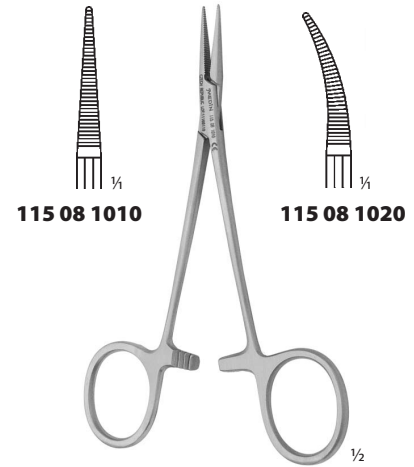
**MOSQUITO-HALSTED**

jemné  
fine  
12,0 cm

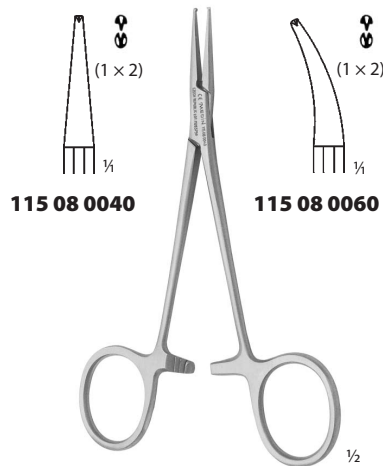
**MOSQUITO-HALSTED**

hladká čelist  
smooth jaw  
12,0 cm

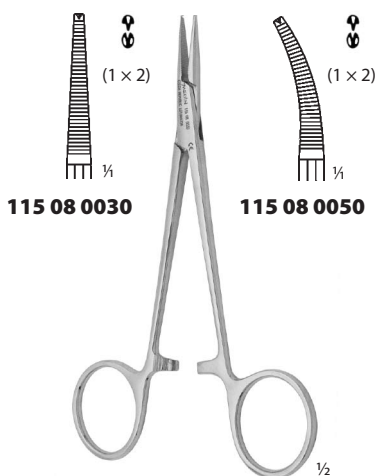
**MOSQUITO-HALSTEAD**

standard  
standard  
12,0 cm

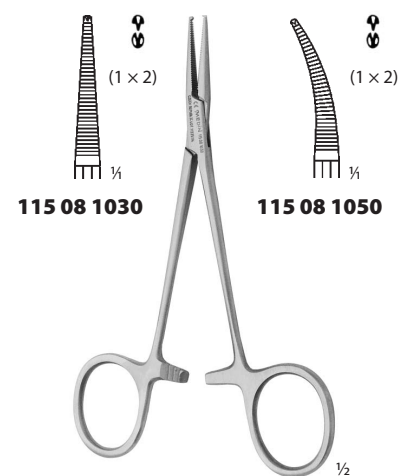
**MOSQUITO-HALSTEAD**

jemné  
fine  
12,0 cm

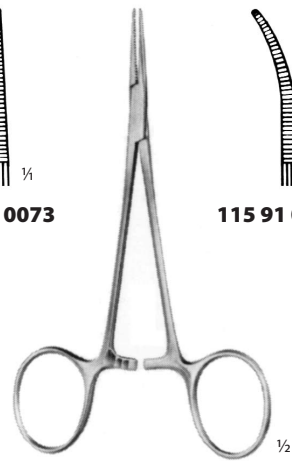
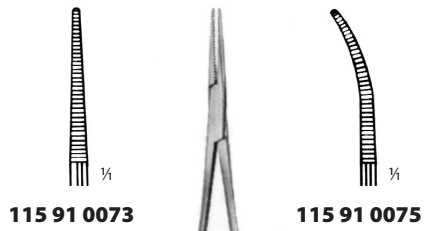

**MICRO-MOSQUITO**  
12,0 cm

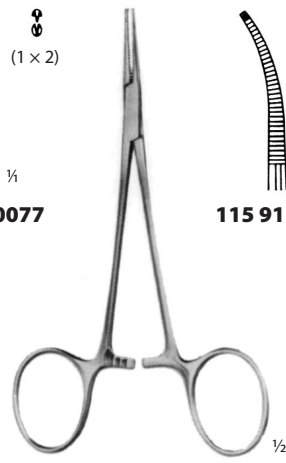
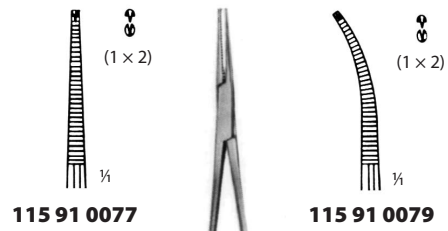

**MICRO-MOSQUITO**  
12,0 cm

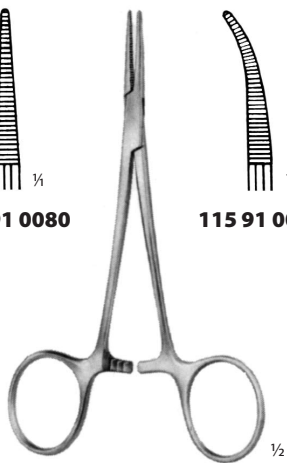
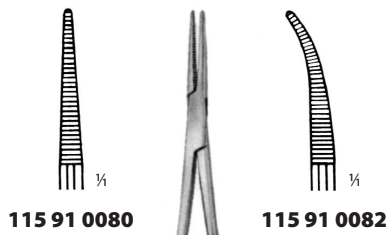

**HALSTEAD-MOSQUITO**  
12,5 cm

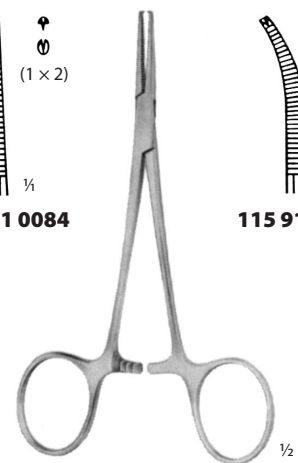
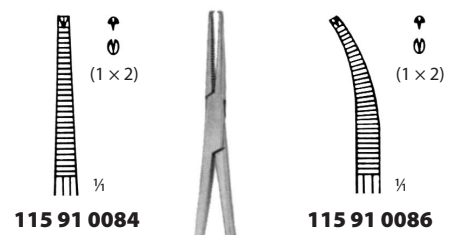

**HALSTEAD-MOSQUITO**  
12,5 cm

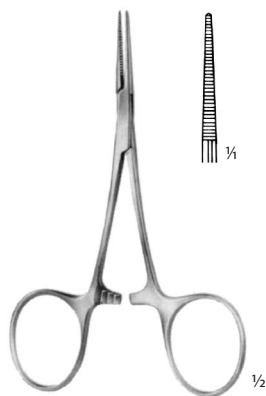

**HARTMANN**  
115 91 0068  
10,0 cm

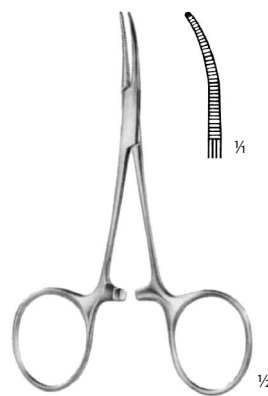

**HARTMANN**  
115 91 0069  
10,0 cm

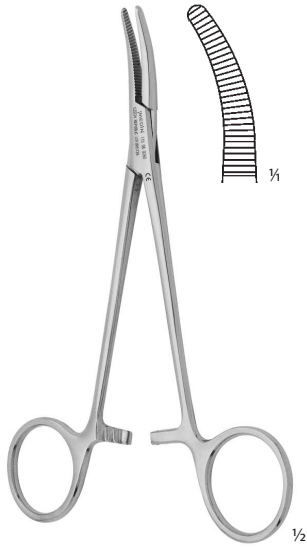
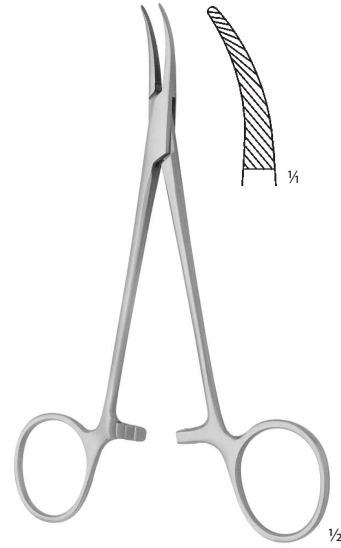
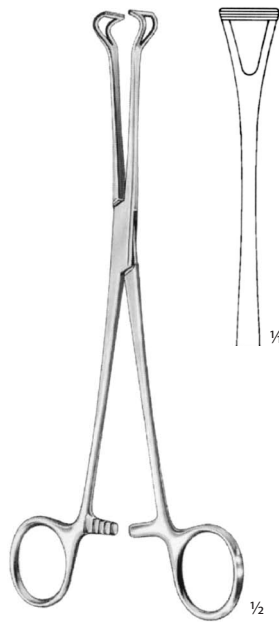
SVORKY NA CÉVY  
ARTERY FORCEPS**ROCHESTER-PEAN**  
**115 08 0260**zahnutá  
curved  
14,0 cm**KELLY**  
**115 08 0500**zahnutá  
curved  
14,0 cmSVORKA CHIRURGICKÁ  
TISSUE FORCEPS**BABCOCK**  
**115 91 0382**

16,0 cm





DE BAKEY

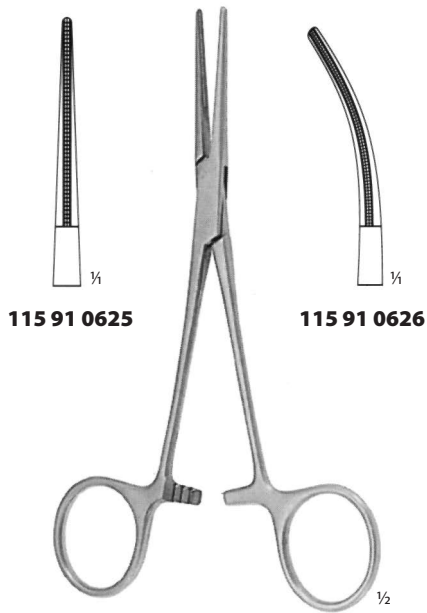

115 91 0625

115 91 0626

**DE BAKEY-RANKIN**  
16,0 cm

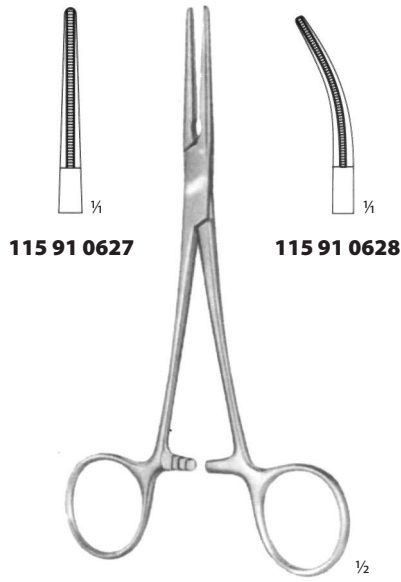

115 91 0627

115 91 0628

**DE BAKEY-MOSQUITO**  
15,0 cm

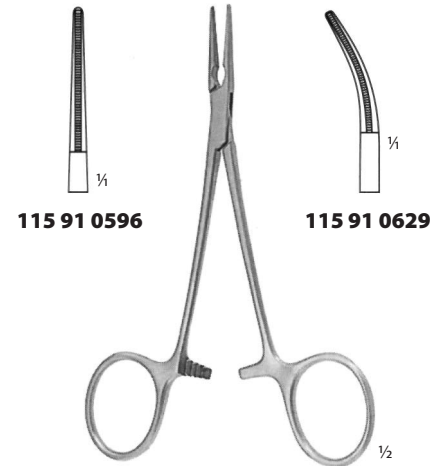

115 91 0596

115 91 0629

**DE BAKEY-MOSQUITO**  
12,0 cm



**DE BAKEY-PEAN**

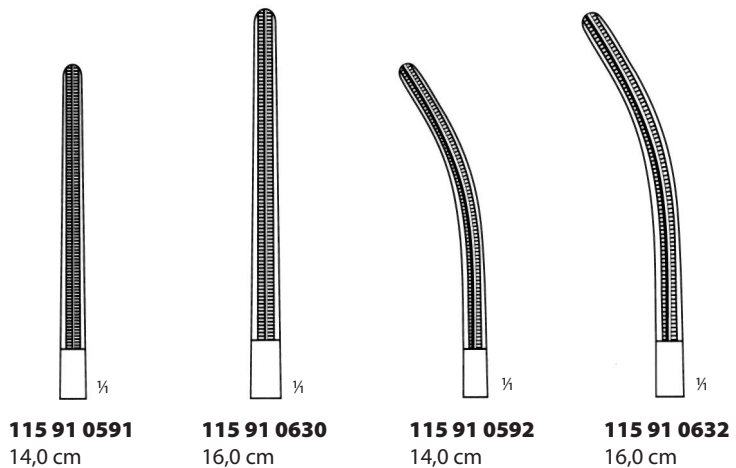

115 91 0591  
14,0 cm

115 91 0630  
16,0 cm

115 91 0592  
14,0 cm

115 91 0632  
16,0 cm

SVORKY NA PRÁDLO  
TOWEL FORCEPS

**BACKHAUS**  
**115 08 0780**  
11,8 cm



**BACKHAUS**  
**115 08 0790**  
12,0 cm



**BACKHAUS-CLIP**  
**115 91 0341**  
11,0 cm



**BACKHAUS**  
**115 91 0343** 11,0 cm  
**115 91 0345** 15,0 cm



**BACKHAUS**  
**115 08 0810** 8,0 cm  
**115 08 0820** 13,0 cm



**ROEDER**  
**115 91 0348** 13,0 cm  
**115 91 0349** 15,0 cm

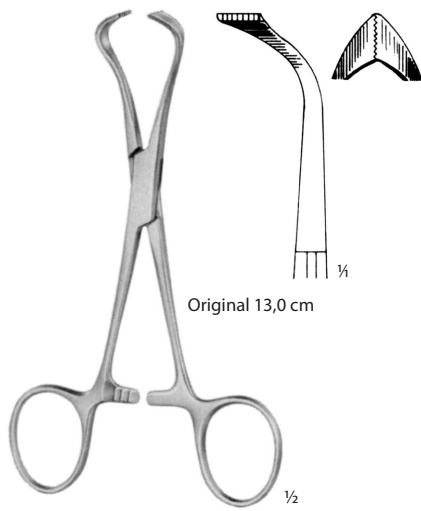

**LORNA**  
**115 91 0350** 10,0 cm  
**115 91 0351** 13,0 cm

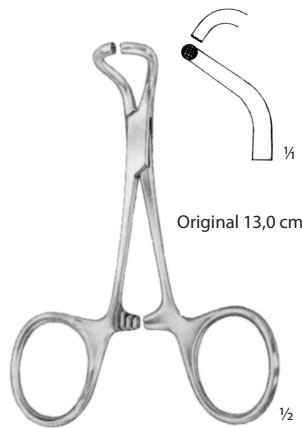

**TOHOKU-JAPAN**  
**115 91 0352** 10,0 cm  
**115 91 0353** 13,0 cm

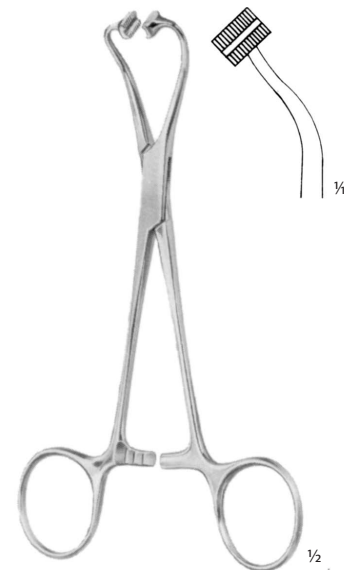

**PEERS**  
**115 91 0354** 14,5 cm

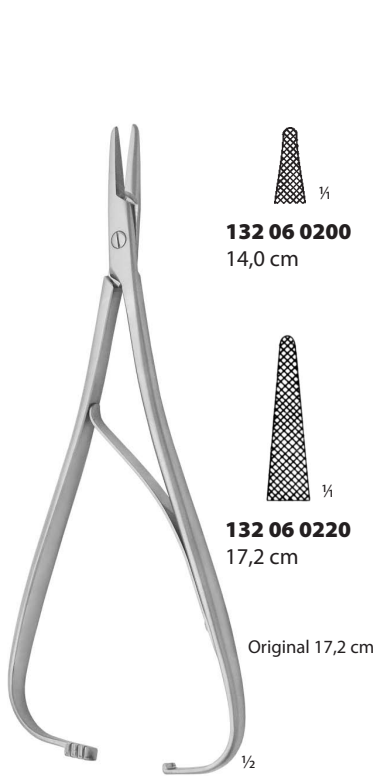

**MATHIEU**

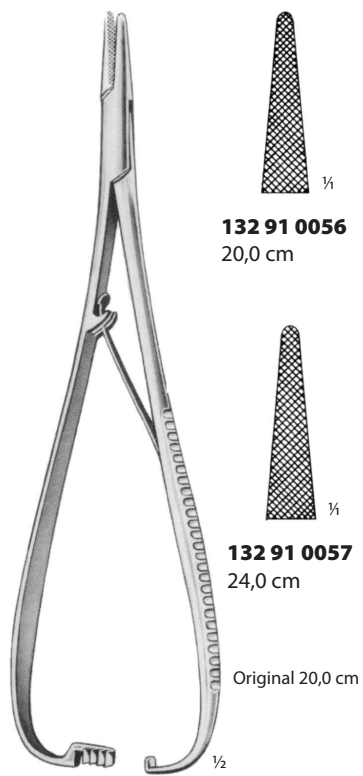
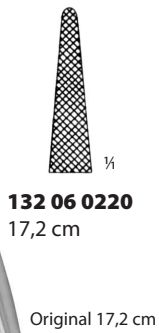

**MATHIEU**

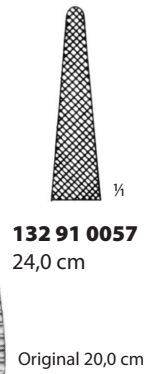

**CRILE**

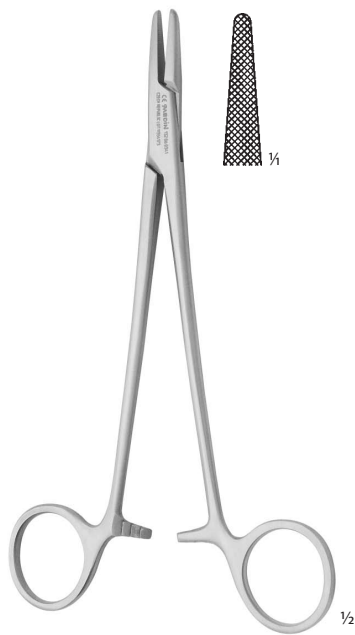



Original 19,0 cm

**OLSEN-HEGAR**

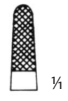

**132 91 0160**  
14,0 cm

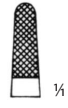

**132 91 0161**  
17,0 cm



**132 91 0162**  
19,0 cm



**132 06 0610**  
16,5 cm



Original 25,5 cm

**RYDER/FRENCH-EYE**  
**132 06 0650**  
25,5 cm

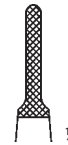

**132 06 0600**  
16,5 cm



**132 06 0640**  
20,5 cm

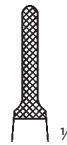

**132 06 0650**  
25,5 cm

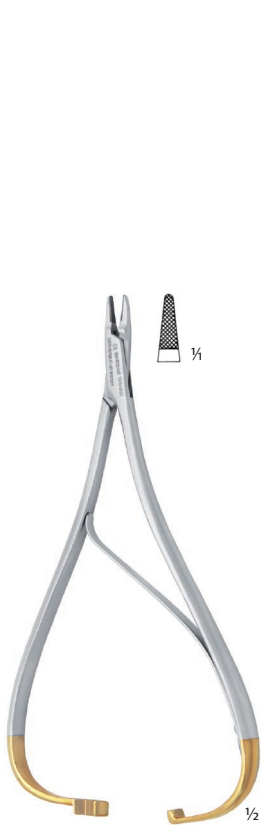

**MATHIEU**  
**132 06 0520**  
14,0 cm

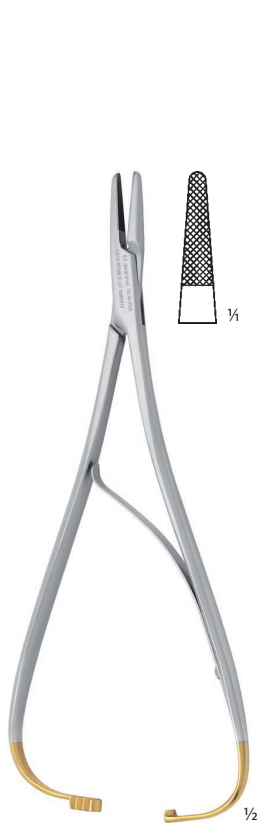

**MATHIEU**  
**132 06 0500**  
17,2 cm



**MATHIEU**  
**132 06 0510**  
21,5 cm



**132 91 0168**  
17,0 cm



**132 91 0169**  
20,0 cm



**132 91 0170**  
23,0 cm



**BOYNTON**  
**132 91 0182**  
12,0 cm

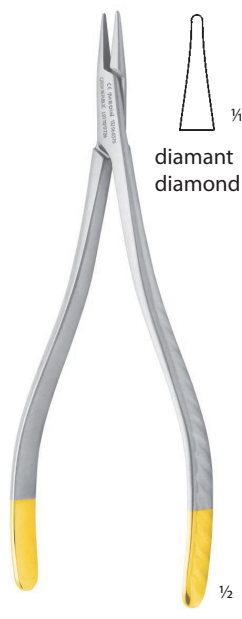

**CRILE**  
**132 06 0370**  
15,7 cm



**CRILE**  
**132 06 0450**  
16,2 cm

JEHELCE TVRDOKOVOVÉ  
NEEDLE HOLDERS WITH TUNGSTEN CARBIDE INSERT

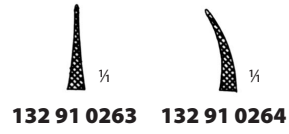
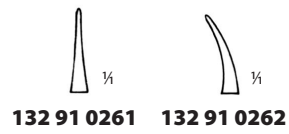
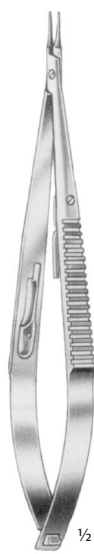

**CASTROVIEJO**  
14,0 cm

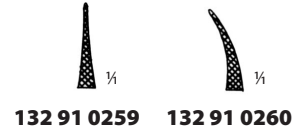
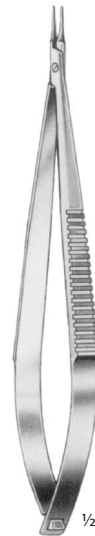

**CASTROVIEJO**  
14,0 cm

MIKRO JEHELCE TVRDOKOVOVÉ  
MICRO-NEEDLE HOLDERS WITH TUNGSTEN CARBIDE INSERT

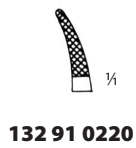
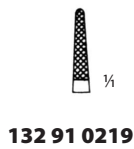
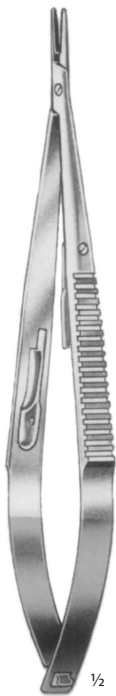

**CASTROVIEJO**  
18,0 cm

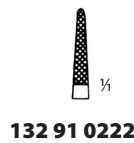
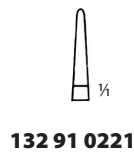
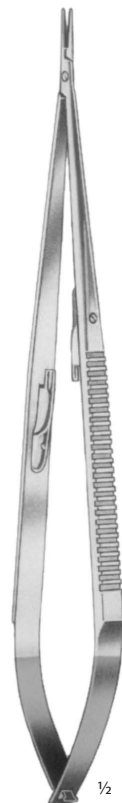

**JACOBSON**  
21,0 cm

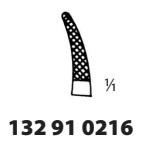
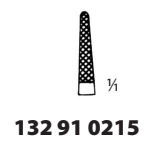

**CASTROVIEJO**  
14,0 cm

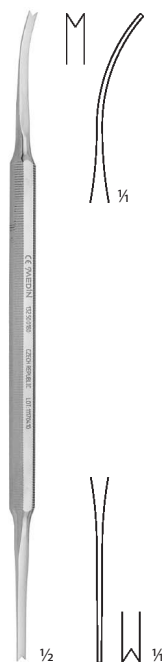
ZAVADĚČE DRENŮ  
DRAIN INTRODUCERS

**LUNIATSCHEK**  
**132 50 0180**  
17,0 cm



**LUNIATSCHEK**  
**132 50 0186**  
16,8 cm







**LUNIATSCHEK**  
**132 56 0186**  
16,8 cm



**LUNIATSCHEK**  
**132 50 0196**  
žlábkový  
grooved  
16,8 cm



**LUNIATSCHEK**  
**132 56 0196**  
žlábkový  
grooved  
16,8 cm

 osmihránné držátko – octagonal handle    5,5 mm   
  plné držátko – round solid handle   
  duté držátko – hollow handle   
  Ø 6,0 mm   
  Ø 8,0 mm

DLAHA PREFABRIKOVANÁ  
PREFABRICATED PLATE

**129 51 0100**  
15,2 cm





**LISTER**  
**113 05 0030**  
15,0 cm



**LISTER**  
**113 05 0040**  
20,0 cm

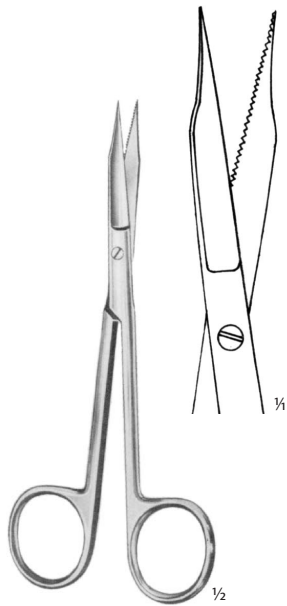

**GOLDMANN-FOX**  
**113 91 0474**  
se zuby, rovné  
saw edge, straight  
13,0 cm

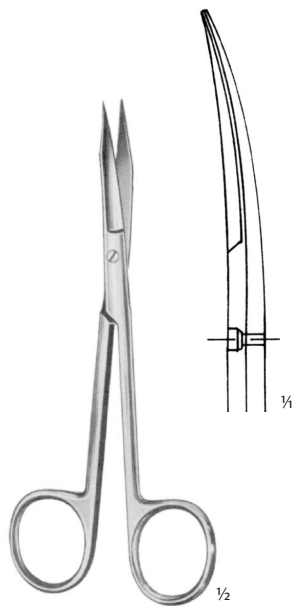

**GOLDMANN-FOX**  
**113 91 0475**  
se zuby, zahnuté  
saw edge, curved  
13,0 cm

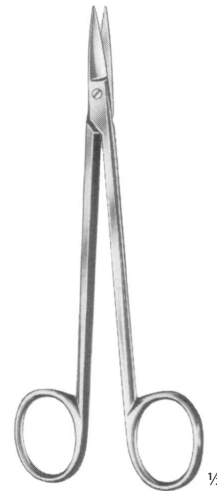

**QUINBY**  
**113 91 0483**  
rovné  
straight  
12,0 cm

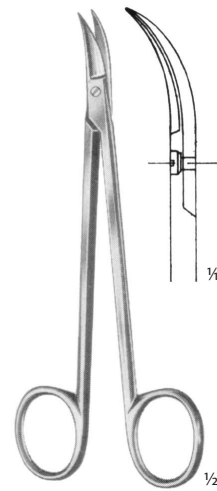

**QUINBY**  
**113 91 0484**  
zahnuté  
curved  
12,0 cm

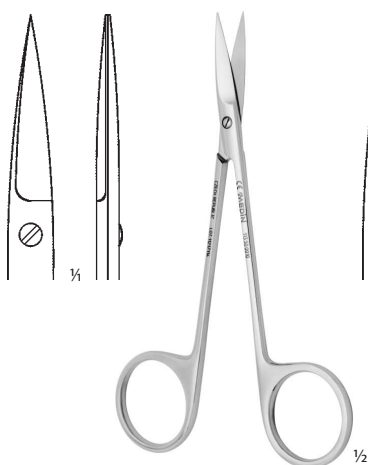

**113 50 0010**  
rovné  
straight  
12,0 cm

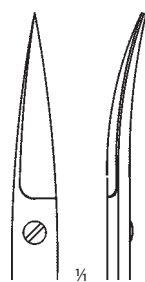

**113 50 0020**  
zahnuté  
curved  
12,0 cm



**113 50 0030**  
rovné  
straight  
14,5 cm



**113 50 0040**  
zahnuté  
curved  
14,5 cm



**SANVENERO**  
**113 91 0221**  
rovné  
straight  
14,0 cm

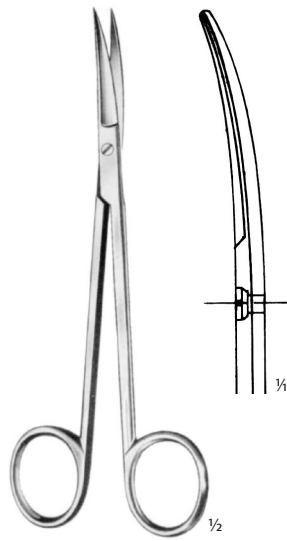

**SANVENERO**  
**113 91 0222**  
zahnuté  
curved  
14,0 cm



**REYNOLDS**  
**113 91 0233**  
rovné  
straight  
15,0 cm

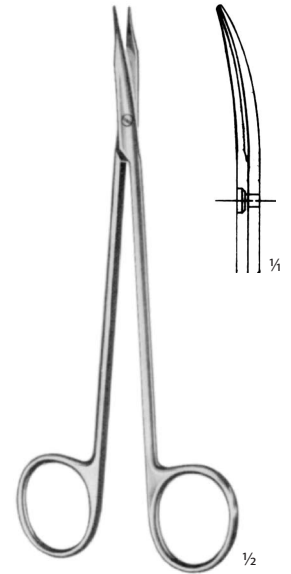

**REYNOLDS**  
**113 91 0235**  
zahnuté  
curved  
15,0 cm

NŮŽKY PRO LIGATURU  
LIGATURE SCISSORS



**SPENCER**  
**113 91 0399**    **113 91 0400**  
9,0 cm            10,5 cm



**LITTAUER**  
**113 91 0403**  
14,0 cm

NŮŽKY CHIRURGICKÉ  
OPERATING SCISSORS

Original 15 cm

STANDARD  
hrotnaté rovné  
sharp straight

**113 08 0010** 13,0 cm  
**113 08 0020** 15,0 cm  
**113 08 0040** 18,5 cm  
**113 08 0060** 22,0 cm  
**113 08 0070** 30,0 cm

1/2



Original 15 cm

STANDARD  
hrotnaté zahnuté  
sharp curved

**113 08 0310** 13,0 cm  
**113 08 0320** 15,0 cm  
**113 08 0340** 18,5 cm  
**113 08 0360** 22,0 cm  
**113 08 0370** 30,0 cm

1/2



Original 15 cm

STANDARD  
hrotnatotupé rovné  
sharp-blunt straight

**113 08 0110** 13,0 cm  
**113 08 0120** 15,0 cm  
**113 08 0140** 18,5 cm  
**113 08 0160** 22,0 cm  
**113 08 0170** 30,0 cm

1/2



Original 15 cm

STANDARD  
hrotnatotupé zahnuté  
sharp-blunt curved

**113 08 0410** 13,0 cm  
**113 08 0420** 15,0 cm  
**113 08 0440** 18,5 cm  
**113 08 0460** 22,0 cm  
**113 08 0470** 30,0 cm

1/2



Original 15 cm

STANDARD  
tupé rovné  
blunt straight

**113 08 0210** 13,0 cm  
**113 08 0220** 15,0 cm  
**113 08 0240** 18,5 cm  
**113 08 0260** 22,0 cm  
**113 08 0270** 30,0 cm

1/2



Original 15 cm

STANDARD  
tupé zahnuté  
blunt curved

**113 08 0510** 13,0 cm  
**113 08 0520** 15,0 cm  
**113 08 0540** 18,5 cm  
**113 08 0560** 22,0 cm  
**113 08 0570** 30,0 cm

1/2



Original 16,5 cm

STANDARD  
hrotnaté rovné  
sharp straight

**113 91 0042** 11,5 cm  
**113 91 0046** 16,5 cm  
**113 91 0049** 20,0 cm

1/2



Original 16,5 cm

STANDARD  
hrotnaté zahnuté  
sharp curved

**113 91 0051** 11,5 cm  
**113 91 0055** 16,5 cm  
**113 91 0058** 20,0 cm

1/2



Original 16,5 cm

STANDARD  
hrotnatotupé rovné  
sharp-blunt straight

**113 91 0020** 11,5 cm  
**113 91 0026** 16,5 cm  
**113 91 0029** 20,0 cm

1/2



Original 16,5 cm

STANDARD  
hrotnatotupé zahnuté  
sharp-blunt curved

**113 91 0031** 11,5 cm  
**113 91 0037** 16,5 cm  
**113 91 0040** 20,0 cm

1/2



Original 16,5 cm

STANDARD  
tupé rovné  
blunt straight

**113 91 0002** 11,5 cm  
**113 91 0006** 16,5 cm  
**113 91 0009** 20,0 cm

1/2



Original 16,5 cm

STANDARD  
tupé zahnuté  
blunt curved

**113 91 0011** 11,5 cm  
**113 91 0015** 16,5 cm  
**113 91 0018** 20,0 cm

1/2

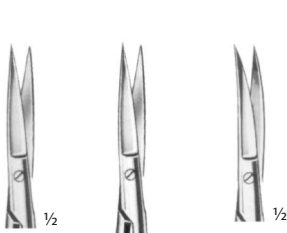
NŮŽKY CHIRURGICKÉ JEMNÉ  
FINE OPERATING SCISSORS

**WAGNER**  
**113 91 0328**  
jemné rovné  
fine straight  
12,0 cm



**WAGNER**  
**113 91 0331**  
jemné zahnuté  
fine curved  
12,0 cm

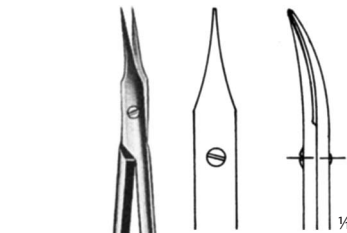

**WALTON**  
**113 91 0348**  
10,0 cm

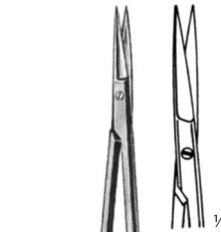

**MOD. BONN**  
**113 91 0349**  
extra jemné  
extra delicate  
8,0 cm

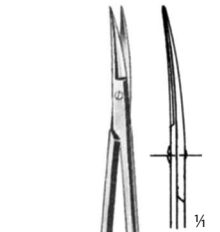

**MOD. BONN**  
**113 91 0350**  
extra jemné  
extra delicate  
8,0 cm

NŮŽKY MIKRO SUPER CUT  
SCISSORS MICRO SUPER CUT

**STILLE**  
**SUPER CUT**  
10 cm

**113 91 0685**  
rovné hrotnaté  
straight sharp

**113 91 0686**  
zahnuté hrotnaté  
curved sharp



**JABALEY-STILLE**  
**SUPER CUT**  
12 cm

**113 91 0687**  
rovné hrotnaté  
straight sharp

**113 91 0688**  
zahnuté hrotnaté  
curved sharp



**STEVENS**  
**SUPER CUT**  
12,5 cm

**113 91 0689**  
rovné hrotnaté  
straight sharp

**113 91 0690**  
zahnuté hrotnaté  
curved sharp

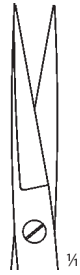

**113 38 0010**  
**113 38 0071**  
hrotnaté rovné  
sharp straight



**113 38 0040**  
**113 38 0091**  
hrotnaté zahnuté  
sharp curved

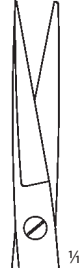

**113 38 0020**  
**113 38 0150**  
hrotnatotupé rovné  
sharp-blunt straight



**113 38 0050**  
**113 38 0100**  
hrotnatotupé zahnuté  
sharp-blunt curved



**113 38 0030**  
**113 38 0081**  
tupé rovné  
blunt straight



**113 38 0060**  
**113 38 0161**  
tupé zahnuté  
blunt curved

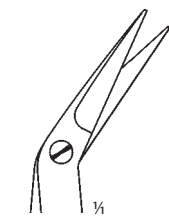

**113 38 0210**  
hrotnaté  
sharp  
10,5 cm



**113 38 0260**  
tupé  
blunt  
10,5 cm



**113 38 0311**  
11,5 cm

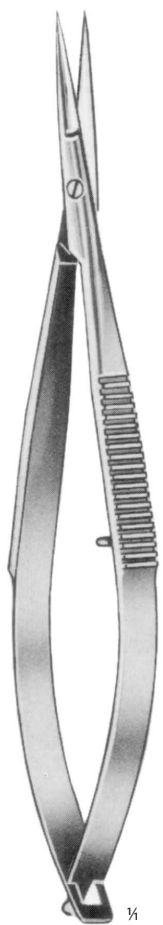

**NOYES**  
12,0 cm



**113 91 0490**



**113 91 0492**



**113 91 0494**

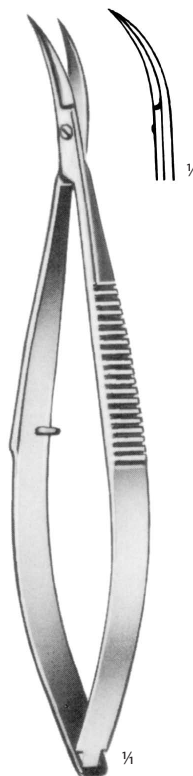

**CASTROVIEJO**  
**113 91 0507**  
10,0 cm

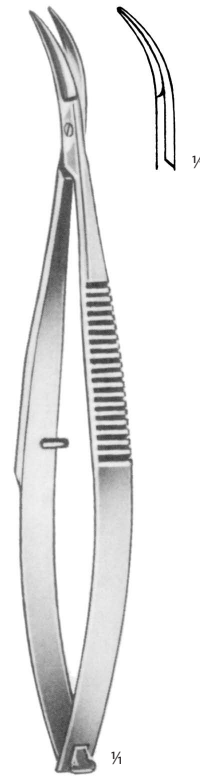

**CASTROVIEJO**  
**113 91 0508**  
10,0 cm

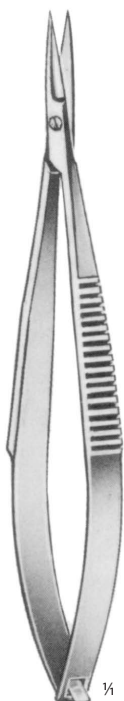

**CASTROVIEJO**  
**113 91 0502**  
9,0 cm



**113 91 0503**

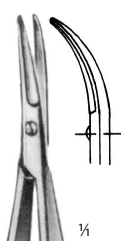

**113 38 1020**



**113 91 0505**



**113 38 1030**





**113 91 0537**

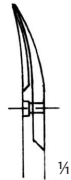

**113 91 0539**



**113 91 0538**

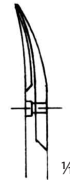

**113 91 0540**

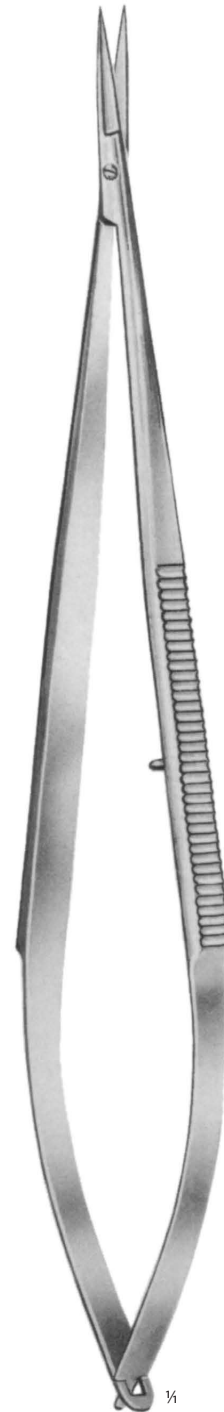

**113 91 0552**



**113 91 0553**



**GOMEL**  
14,5 cm

**GOMEL**  
18,0 cm

18,5 cm

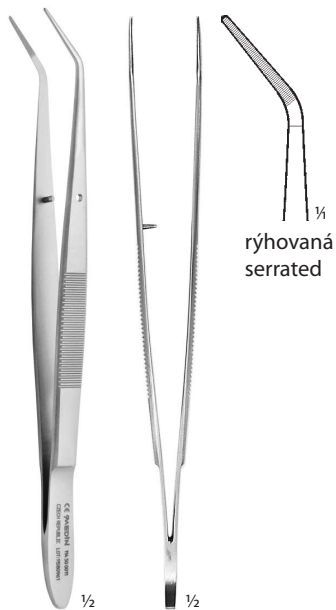

**114 50 0011**  
zahnutá  
curved  
15,7 cm

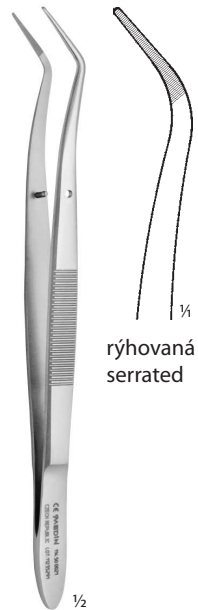

**114 50 0021**  
lomená  
angled  
15,7 cm



**114 50 0031**  
lomená  
angled  
15,7 cm

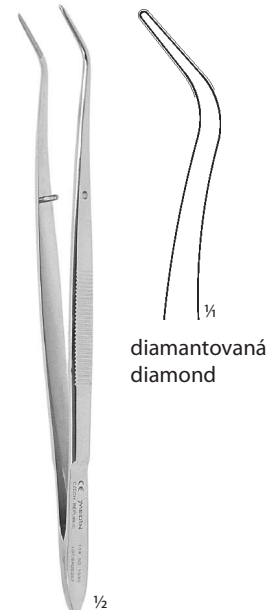

**114 50 1030**  
lomená  
angled  
15,7 cm



**114 50 0051**  
15,7 cm



**114 50 0150**  
zahnutá, jemná  
curved, fine  
14,2 cm



**114 50 0170**  
zahnutá  
curved  
15,7 cm



**114 08 0090**  
14,5 cm



**114 08 0101**  
jemná  
fine  
14,5 cm



**114 08 0231**  
velmi jemná  
very fine  
14,5 cm



**114 08 0140**  
jemná  
fine  
20,0 cm



**114 08 0240**  
velmi jemná  
very fine  
20,0 cm



**114 08 0250**  
24,5 cm

**PINZETY ANATOMICKÉ**  
DRESSING FORCEPS



Original 14,5 cm

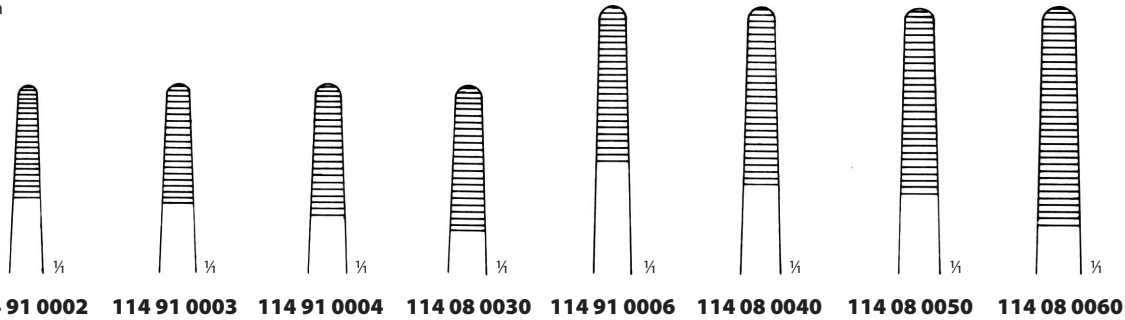

**114 91 0002**   **114 91 0003**   **114 91 0004**   **114 08 0030**   **114 91 0006**   **114 08 0040**   **114 08 0050**   **114 08 0060**

**114 91 0002** 11,5 cm  
**114 91 0003** 13,0 cm  
**114 91 0004** 14,5 cm  
**114 08 0030** 16,0 cm  
**114 91 0006** 18,0 cm  
**114 08 0040** 20,0 cm  
**114 08 0050** 25,0 cm  
**114 08 0060** 30,0 cm

**PINZETY CHIRURGICKÉ**  
TISSUE FORCEPS



Original 14,5 cm  
 (1 × 2)

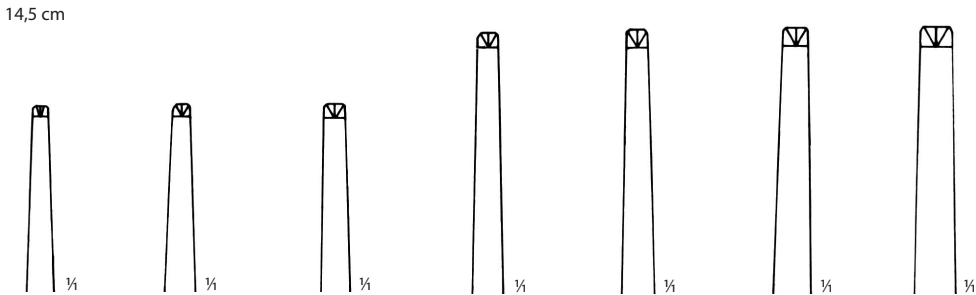

**114 91 0011**   **114 91 0012**   **114 08 0381**   **114 91 0015**   **114 08 0340**   **114 08 0350**   **114 08 0360**

**114 91 0011** 11,5 cm  
**114 91 0012** 13,0 cm  
**114 08 0381** 14,5 cm  
**114 91 0015** 18,0 cm  
**114 08 0340** 20,0 cm  
**114 08 0350** 25,0 cm  
**114 08 0360** 30,0 cm



**114 08 0430**  
jemná  
fine  
16,0 cm



**114 08 0530**  
velmi jemná  
very fine  
14,5 cm

PINZETY ŠÍČÍ  
SUTURING FORCEPS



**114 91 0255**  
12,0 cm

**114 91 0257**  
12,0 cm

**114 91 0256**  
15,0 cm

**114 91 0258**  
15,0 cm

**PINZETY TVRDOKOVOVÉ**  
FORCEPS WITH TUNGSTEN CARBIDE INSERT



**114 91 0477**  
14,0 cm

**114 91 0478**  
16,0 cm

**114 91 0479**  
18,0 cm

Original 18,0 cm



**114 91 0480**  
20,0 cm

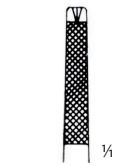

**114 91 0481**  
25,0 cm

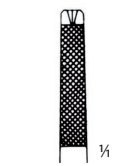

**114 91 0482**  
30,0 cm

**OEHLER**



Original 12,0 cm



**114 91 0487**  
12,0 cm

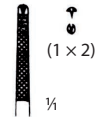

**114 91 0490**  
12,0 cm



**114 91 0489**  
15,0 cm

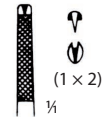

**114 91 0491**  
15,0 cm

**ADSON**



Original 12,5 cm

**SEMKEN**  
**114 91 0483** 12,5 cm  
**114 91 0484** 15,5 cm

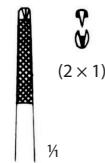

**GILLIES**  
**114 91 0485**  
15,0 cm



**JEWELER**  
**114 91 0486**  
15,0 cm

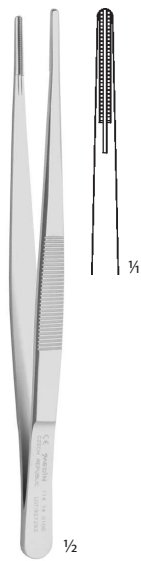

**114 14 0100**  
14,5 cm

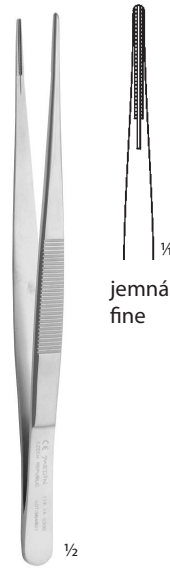

**114 14 0300**  
14,5 cm



jemná  
fine

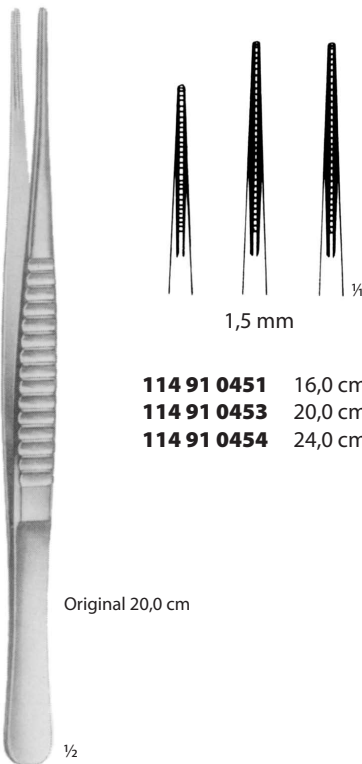

**114 91 0451** 16,0 cm  
**114 91 0453** 20,0 cm  
**114 91 0454** 24,0 cm

Original 20,0 cm

DE BAKEY

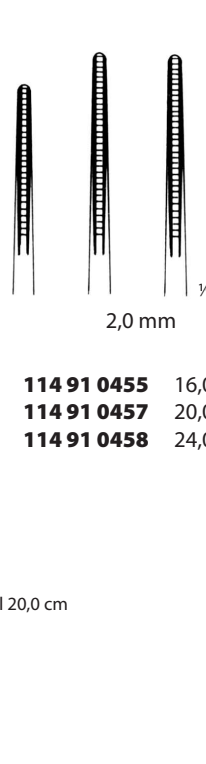

**114 91 0455** 16,0 cm  
**114 91 0457** 20,0 cm  
**114 91 0458** 24,0 cm

Original 20,0 cm

DE BAKEY

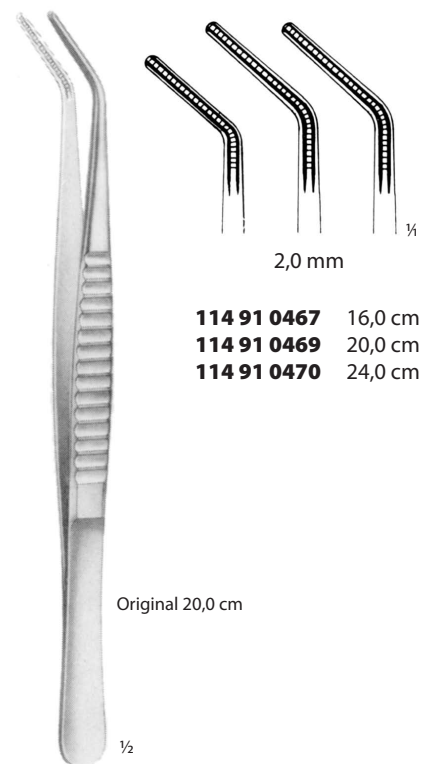

**114 91 0467** 16,0 cm  
**114 91 0469** 20,0 cm  
**114 91 0470** 24,0 cm

Original 20,0 cm

DE BAKEY



**GRAEFE**  
10,5 cm

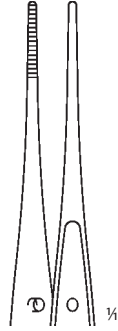

**114 38 0010**

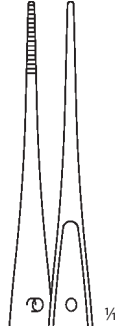

**114 38 0020**  
jemná  
fine

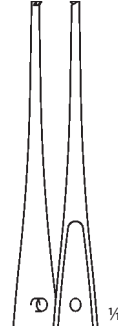

**114 38 0150**

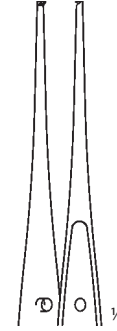

**114 38 0160**  
jemná  
fine

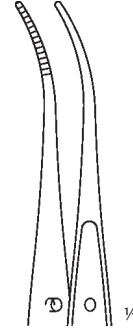

**114 38 0100**  
jemná  
fine



se zámkem  
with lock

**GRAEFE**  
**114 38 0360**  
11,0 cm



**B**

**DIAGNOSTIKA**  
**DIAGNOSTICS**



<b>Sondy, pátridla</b>	Probes	73
<b>Lopatky</b>	Spatulas	74
<b>Zrcátka</b>	Mirrors	74–75
<b>Stomatologické soubory</b>	Stomatological Sets	76

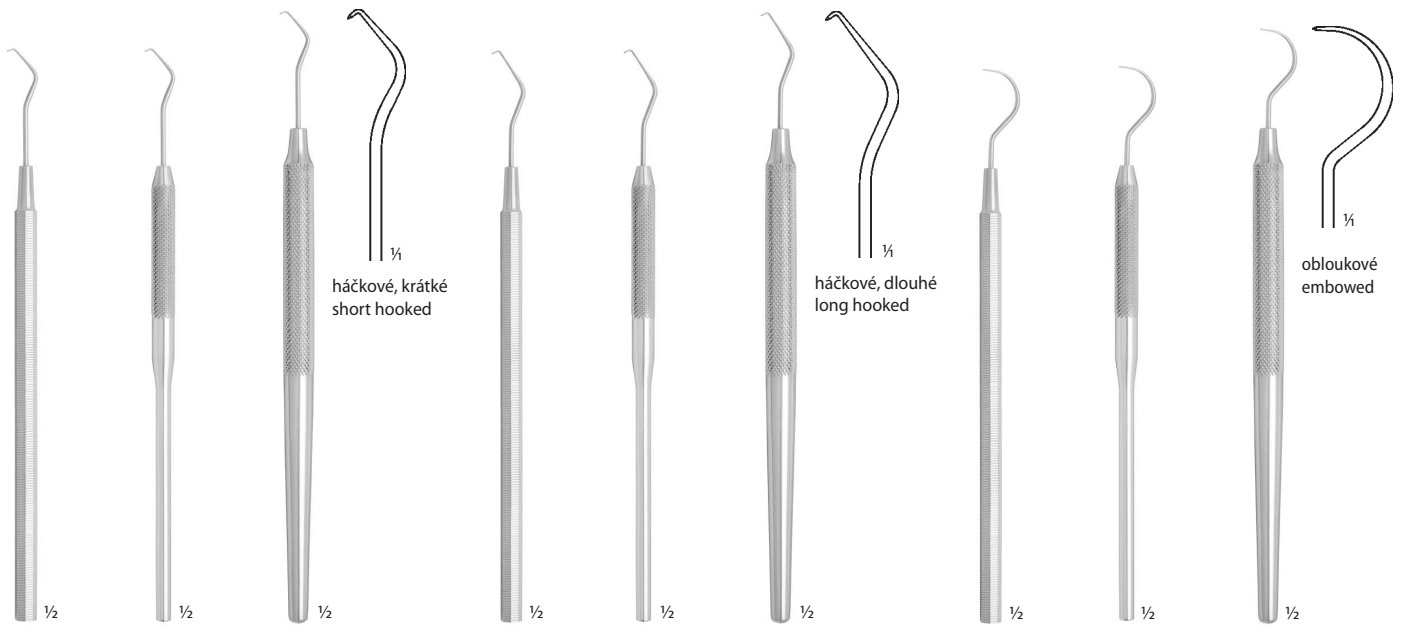

<b>133 51 0010</b>	<b>133 51 0016</b>	<b>133 56 0016</b>	<b>133 51 0020</b>	<b>133 51 0026</b>	<b>133 56 0026</b>	<b>133 51 0030</b>	<b>133 51 0036</b>	<b>133 56 0036</b>
15,2 cm	15,2 cm	16,3 cm	15,1 cm	15,1 cm	16,2 cm	14,5 cm	14,5 cm	15,6 cm

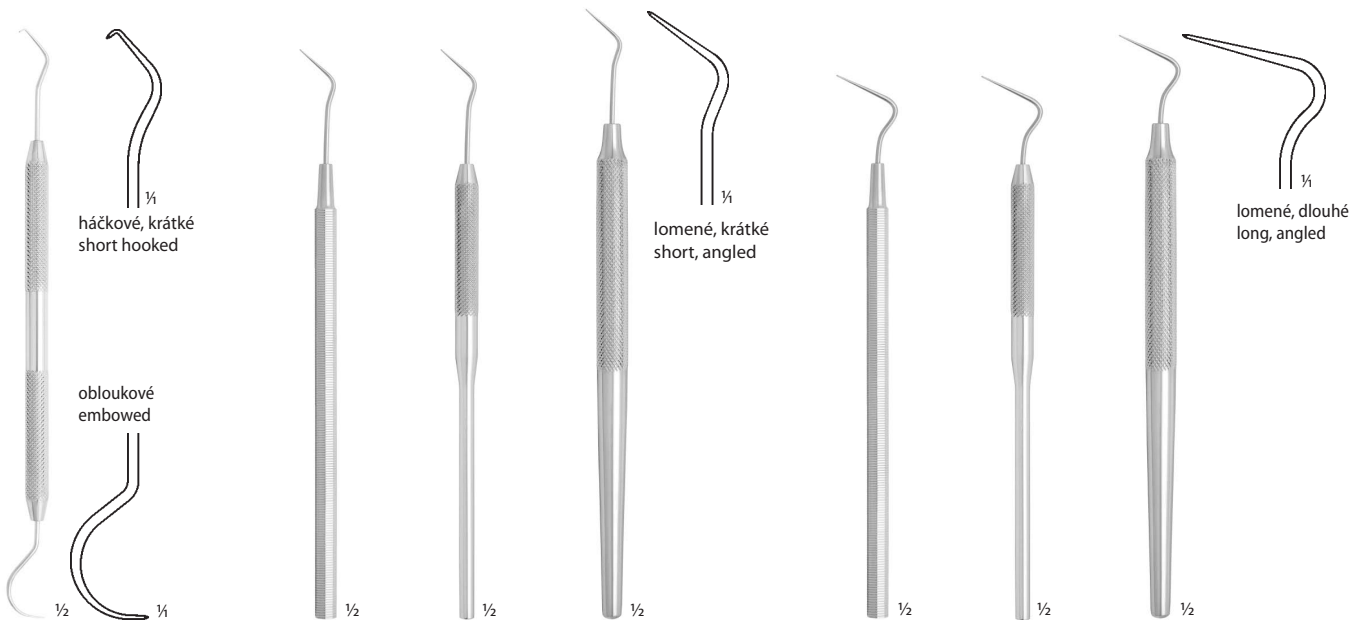

<b>133 99 0186</b>	<b>133 51 0040</b>	<b>133 51 0046</b>	<b>133 56 0046</b>	<b>133 51 0050</b>	<b>133 51 0056</b>	<b>133 56 0056</b>
15,7 cm	15,0 cm	15,0 cm	16,1 cm	14,0 cm	14,0 cm	15,1 cm



**BUCHWALD**  
**121 31 0010**  
17,3 cm  
16/23 mm



**BRÜNNINGS**  
**121 31 0020**  
19,5 cm  
14/18 mm

ZRCÁTKA INTRAORÁLNÍ  
INTRAORAL MIRRORS

**HR FRONT  
BUCCAL**  
**121 91 0420**  
přední vrstva se zvýšenou odrazivostí,  
jednostranné, síla 3 mm, šířka 4 cm  
high reflection front coating  
one-side coated, thickness 3 mm, bridth 4 cm  
16,0 cm



**HR FRONT  
OCCLUSAL**  
**121 91 0421**  
přední vrstva se zvýšenou odrazivostí,  
jednostranné, síla 3 mm, šířka 6,5/4 cm  
high reflection front coating  
one-side coated, thickness 3 mm, bridth 6,5/4 cm  
15,0 cm



**HR FRONT  
LINGUAL**  
**121 91 0422**  
přední vrstva se zvýšenou odrazivostí,  
oboustranné, síla 2 mm  
high reflection front coating  
double-side coated, thickness 2 mm  
16,0 cm



přední vrstva  
front surface



**122 51 0010**  
 1 : 1  
 ploché  
 plane  
 Ø 24 mm



**122 51 0020**  
 2,25×  
 zvětšovací  
 magnifying  
 Ø 24 mm



**HR FRONT**  
 přední vrstva se zvýšenou odrazivostí  
 high reflection front coating  
**122 91 0411** 1 : 1 Fig. 8 Ø 30 mm  
**122 91 0333** 1 : 1 Fig. 5 Ø 24 mm  
**122 91 0407** 1 : 1 Fig. 4 Ø 22 mm  
**122 91 0408** 1 : 1 Fig. 0 Ø 14 mm



přední vrstva  
 front surface

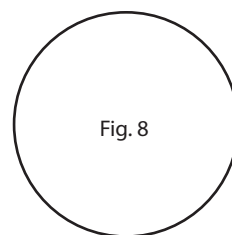

Fig. 8

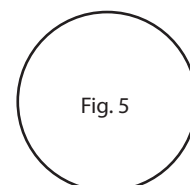

Fig. 5

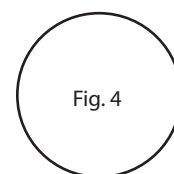

Fig. 4



Fig. 0

POZNÁMKY: balení 12 ks  
 NOTES: packing 12 pcs

**DRŽÁTKA ZUBNÍCH ZRCÁTEK**  
**DENTAL MIRROR HANDLES**

● **122 51 0100**  
 osmihranné držátko 5,5 mm  
 octagonal handle 5,5 mm  
 12,0 cm



● **122 51 0106**  
 plné držátko Ø 6,0 mm  
 round solid handle Ø 6,0 mm  
 12,0 cm



○ **122 56 0106**  
 duté držátko Ø 8,0 mm  
 hollow handle Ø 8,0 mm  
 13,0 cm

SOUBOR STOMATOLOGICKÝ VYŠETŘOVACÍ  
EXAMINATION STOMATOLOGICAL SET**139 50 0120**

soubor

set

22,0 × 10,5 × 3,6 cm

			počet ks number of pcs
<b>114 50 0011</b>	Pinzeta zubní zahnutá, rýhovaná	Tweezer – curved, serrated	1
<b>122 51 0020</b>	Zrcátko zubní zvětšovací	Dental mirror – magnifying	1
<b>122 51 0100</b>	Držátko zubního zrcátka	Dental handle	1
<b>133 51 0050</b>	Pátradlo zubní lomené, dlouhé	Dental probe – long, angled	1
<b>139 50 0150</b>	Držák (aluminium)	Holder (aluminium)	1
<b>139 50 0170</b>	Kazeta (aluminium)	Cassette (aluminium)	1
<b>147 51 0040</b>	Srpek na zubní kámen	Scaler	1
<b>148 51 0110</b>	Exkavátor, oboustranný	Excavator, double-faced	1



# ZÁCHOVNÁ STOMATOLOGIE

## RESTORATIVE



<b>Exkavátory</b>	Excavators	79–80
<b>Nástroje pro výplně</b>	Filling Instruments	81–94
<b>Lopatky</b>	Spatulas	95
<b>Matrice</b>	Matrixes	96–97
<b>Nástroje na snímání korunek</b>	Crown Removers	98



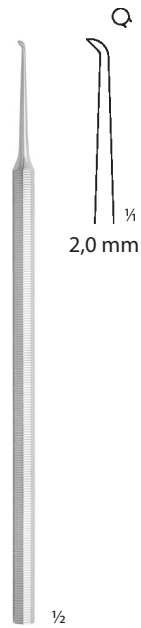

**148 51 0010**  
rovný  
straight  
15,5 cm

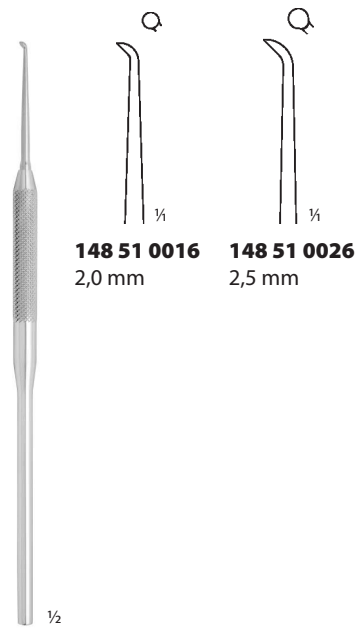

**148 51 0016**  
rovný  
straight  
15,5 cm



**148 51 0056**  
pravý  
right  
15,5 cm

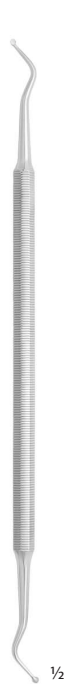

**148 51 0076**  
levý  
left  
15,5 cm

EXKAVÁTORY  
EXCAVATORS

**148 51 0100**  
1,5 mm



**148 51 0110**  
2,0 mm



**148 51 0120**  
2,5 mm



**148 51 0100**  
oboustranný  
double faced  
17,0 cm



**148 51 0096**  
0,8 mm



**148 51 0136**  
1,0 mm



**148 51 0106**  
1,5 mm



**148 51 0116**  
2,0 mm



**148 51 0126**  
2,5 mm



**148 51 0106**  
oboustranný  
double faced  
16,8 cm

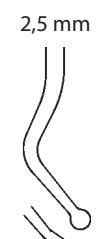

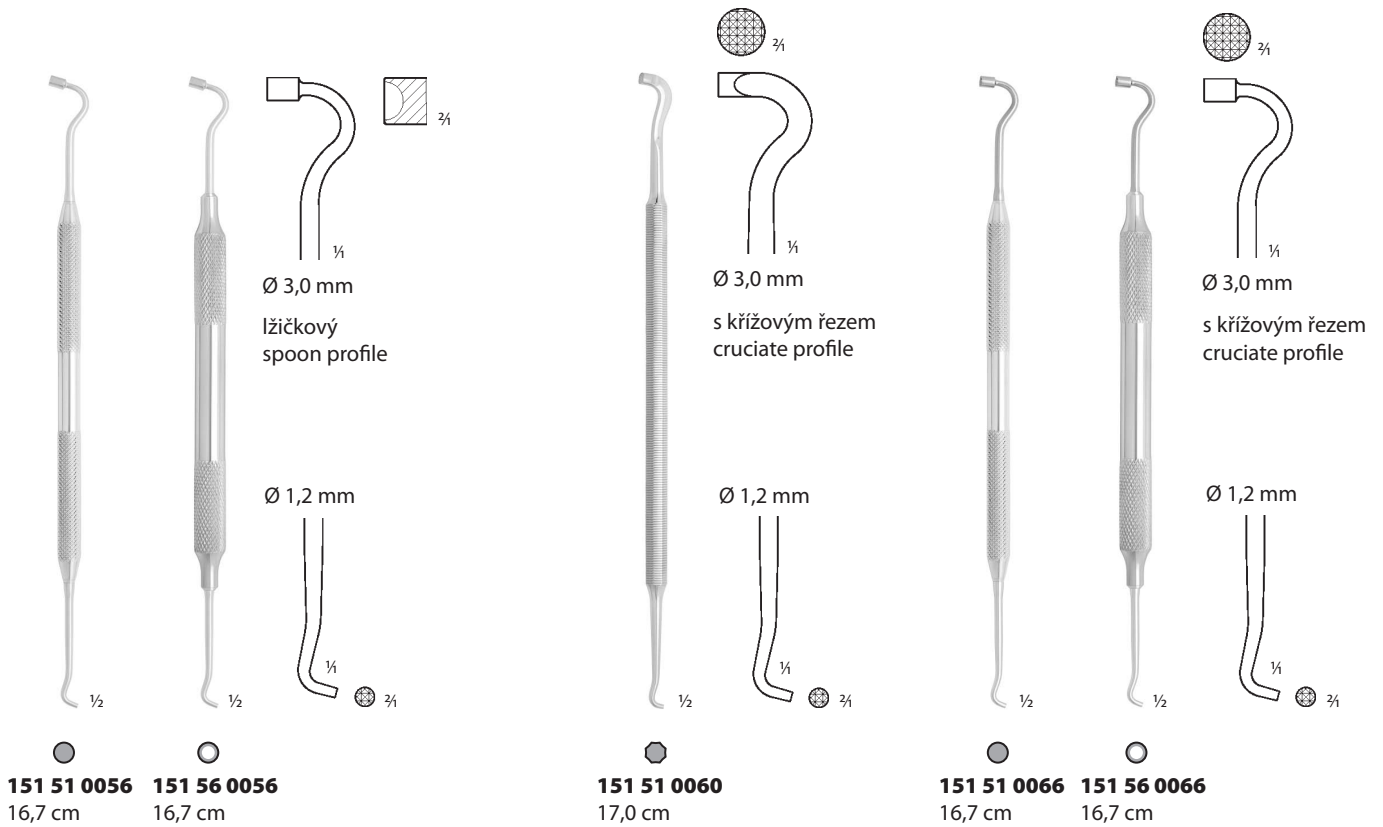
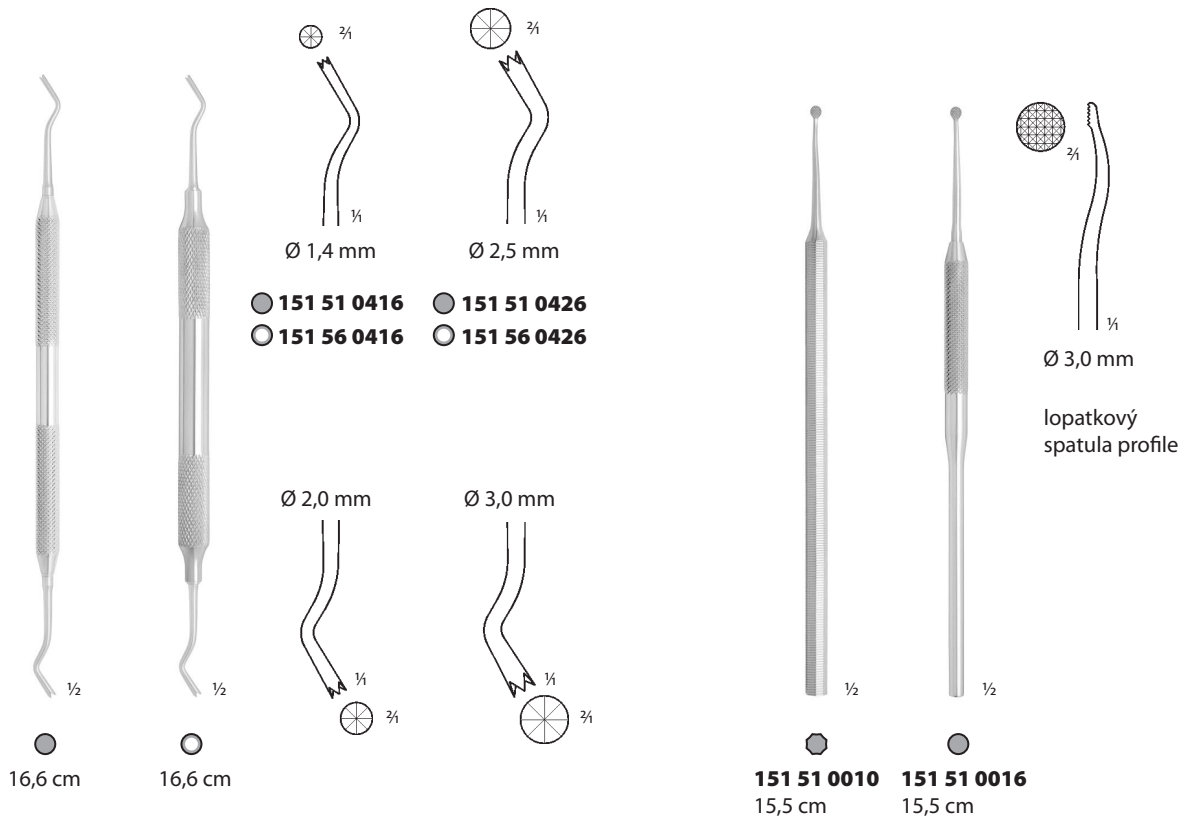

CPÁTKA  
FILLING INSTRUMENTS

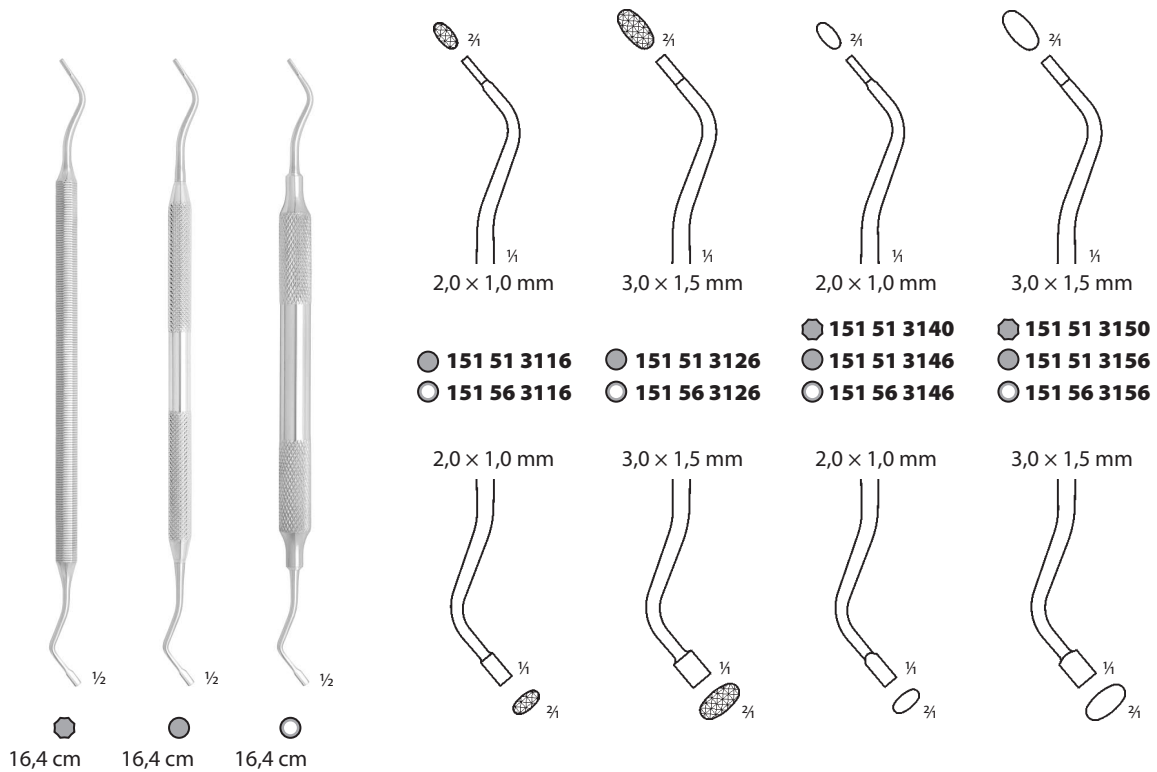
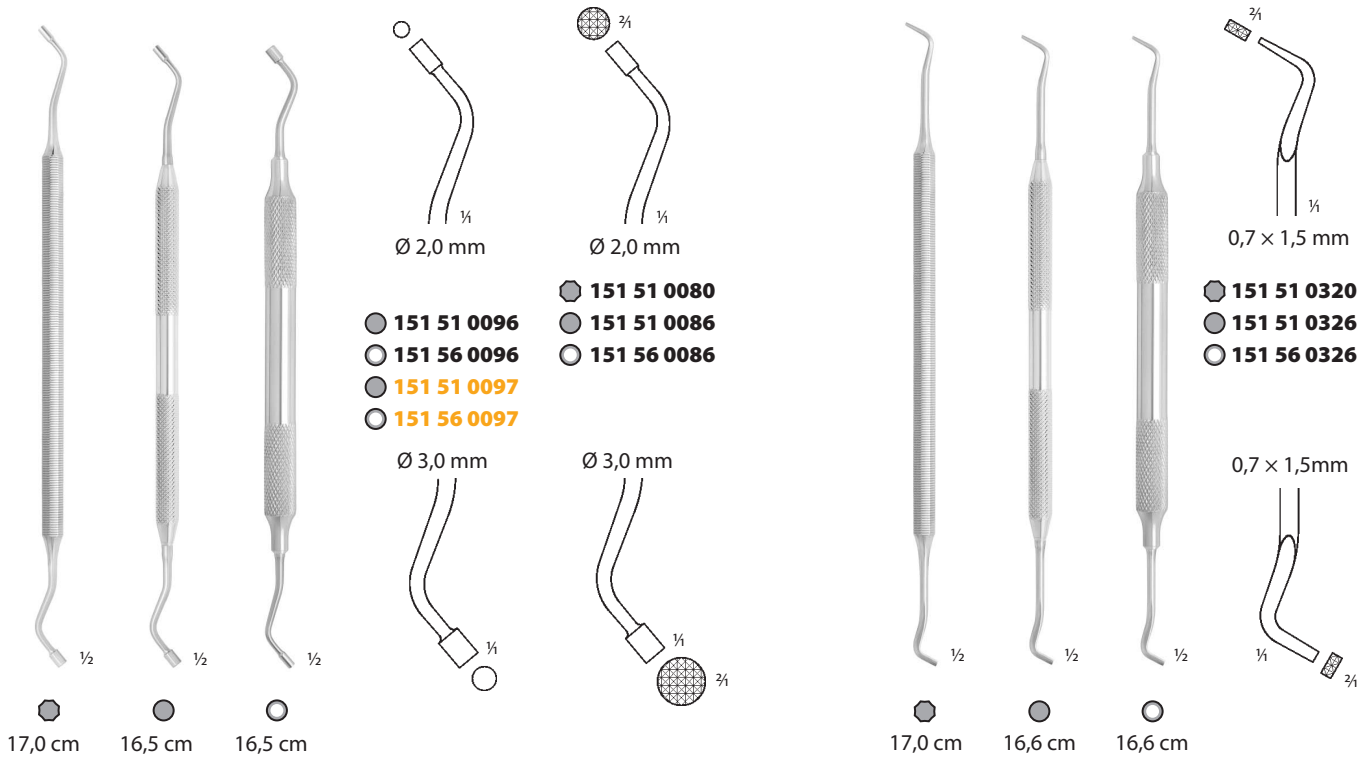

●	osmihranné držátko – octagonal handle	5,5 mm
○	plné držátko – round solid handle	Ø 6,0 mm
○	duté držátko – hollow handle	Ø 8,0 mm

<b>151 5X XXXX</b>	nerez – stainless steel
<b>151 5X XXXX</b>	TiN povlak – TiN surface



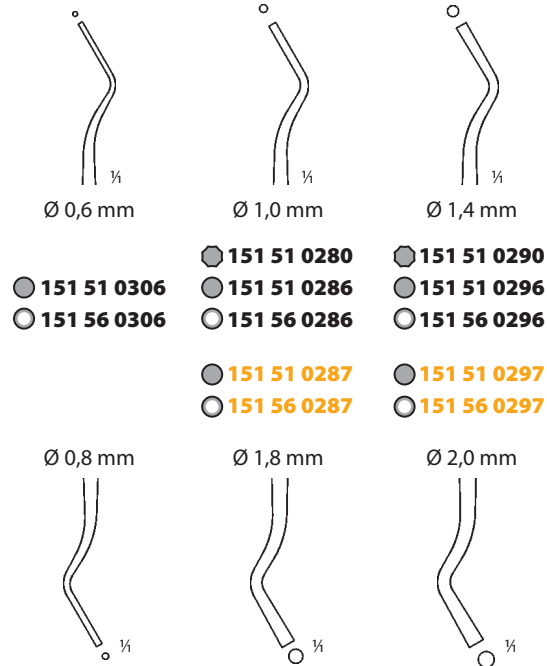

- 151 51 0306    ● 151 51 0280    ● 151 51 0290
- 151 56 0306    ● 151 51 0286    ● 151 51 0296
- 151 56 0286    ● 151 56 0286    ● 151 56 0296
- 151 51 0287    ● 151 51 0297
- 151 56 0287    ● 151 56 0297

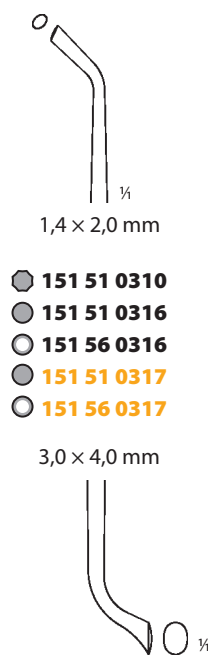
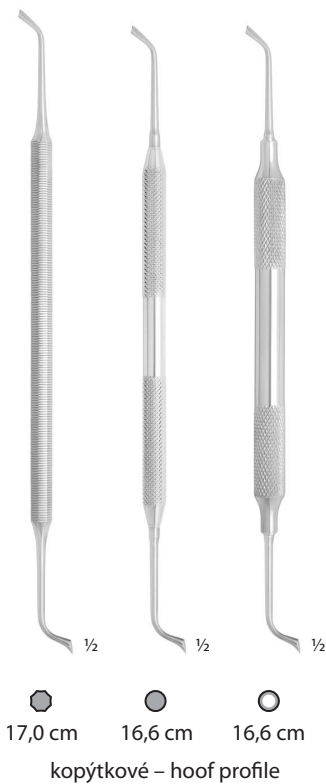

- 151 51 0310
- 151 51 0316
- 151 56 0316
- 151 51 0317
- 151 56 0317

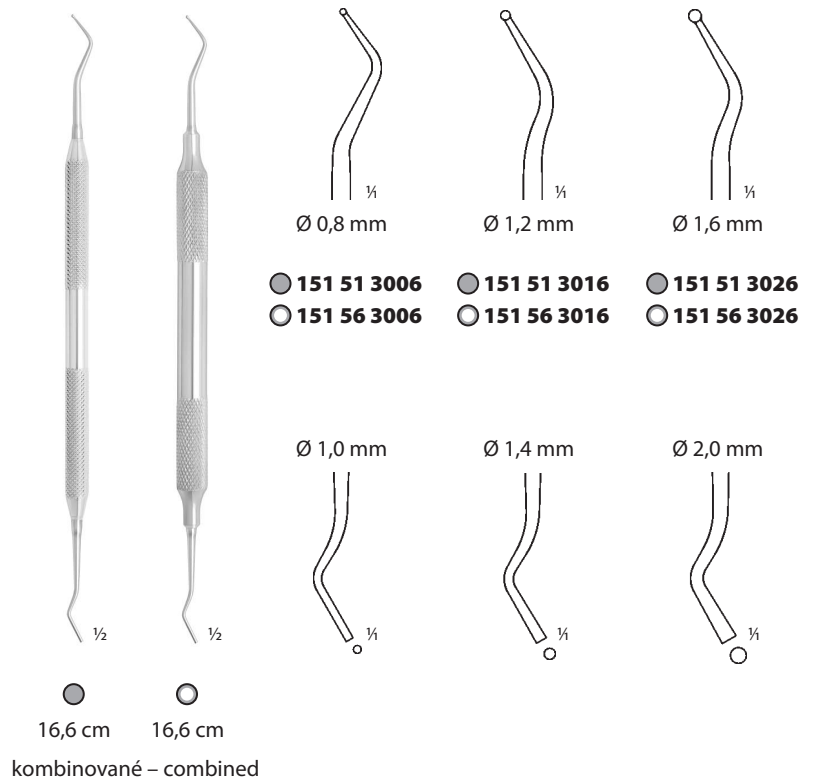

- 151 51 3006    ● 151 51 3016    ● 151 51 3026
- 151 56 3006    ● 151 56 3016    ● 151 56 3026

● osmihřanné držátko – octagonal handle	5,5 mm
● plné držátko – round solid handle	Ø 6,0 mm
● duté držátko – hollow handle	Ø 8,0 mm

151 5X XXXX	nerez – stainless steel
151 5X XXXX	TiN povlak – TiN surface



CPÁTKA  
FILLING INSTRUMENTS

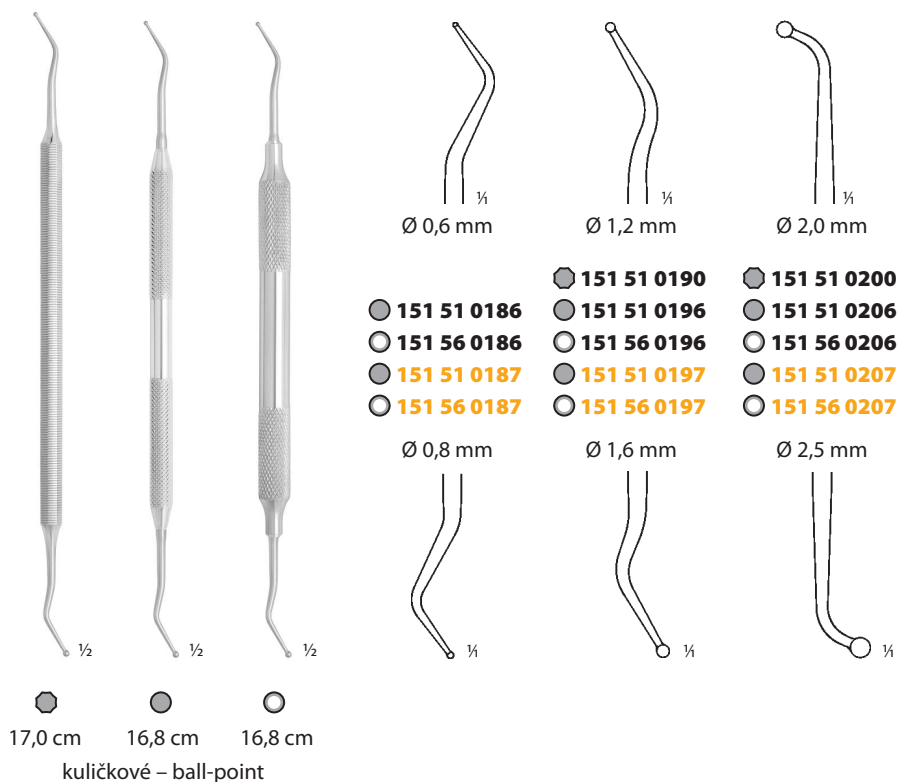

CPÁTKA KOŘENOVÁ  
FILLING INSTRUMENTS

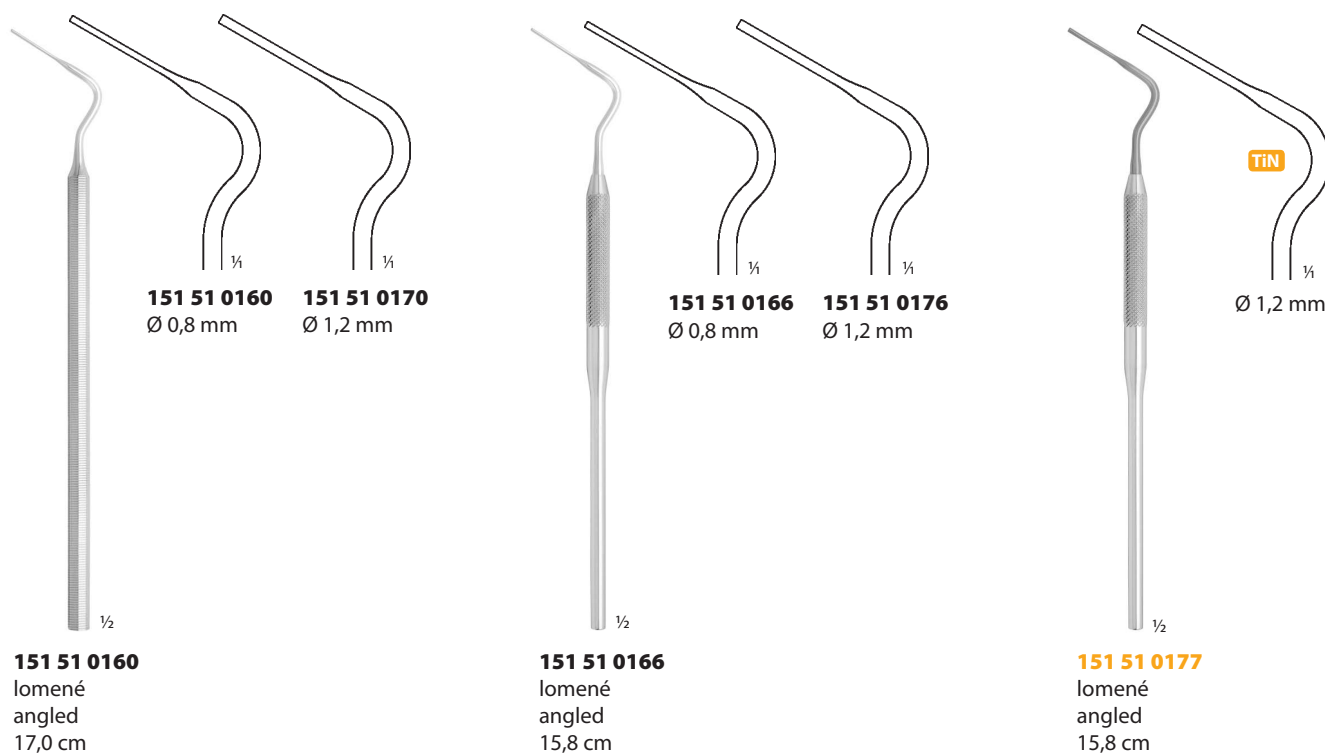

● osmihranné držátko – octagonal handle	5,5 mm
○ plné držátko – round solid handle	Ø 6,0 mm
○ duté držátko – hollow handle	Ø 8,0 mm

151 5X XXXX	nerez – stainless steel
151 5X XXXX	TiN povlak – TiN surface



CPÁTKA VLÁKNA DO SULKU  
FIBRE FILLING INSTRUMENTS

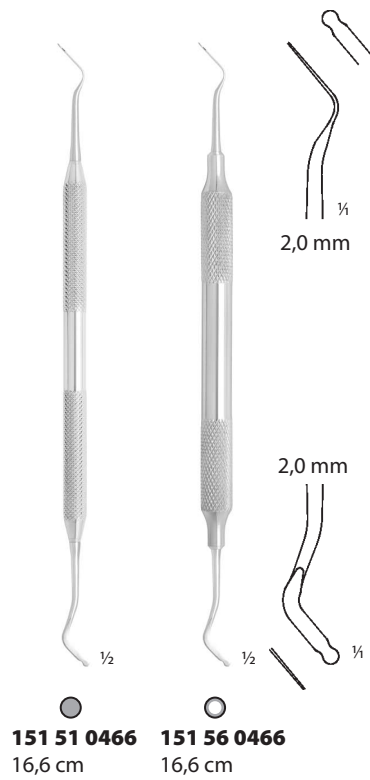

ZAVADĚČE RETRAKČNÍCH VLÁKEN  
RETENTIVE FIBRE INSTRUMENTS

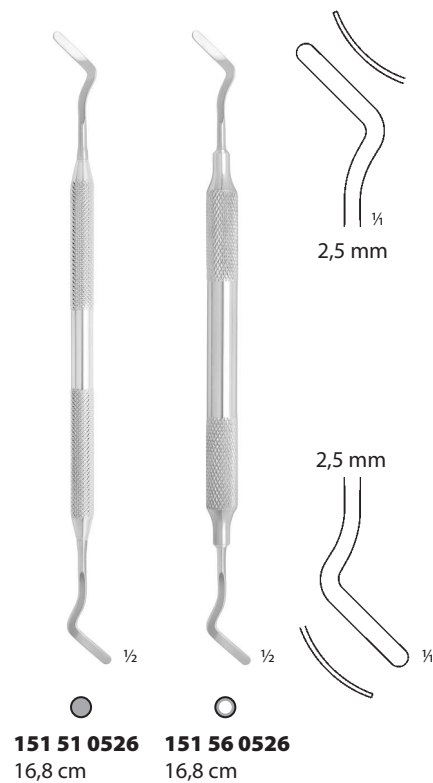
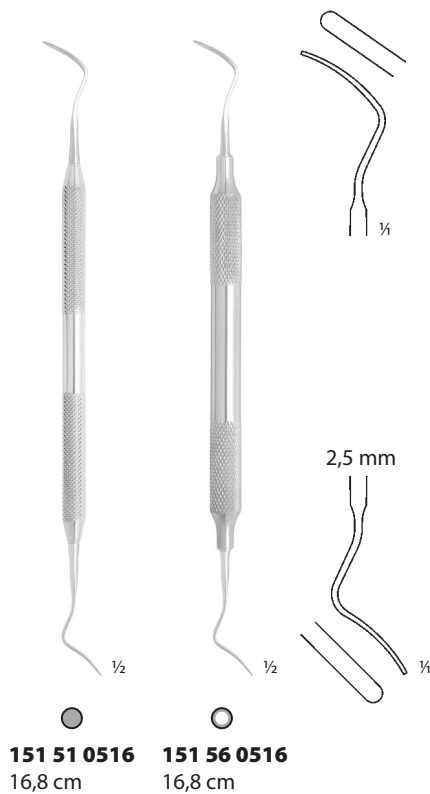

HLADÍTKA SE CPÁTKEM  
SPATULAS – FILLING INSTRUMENTS

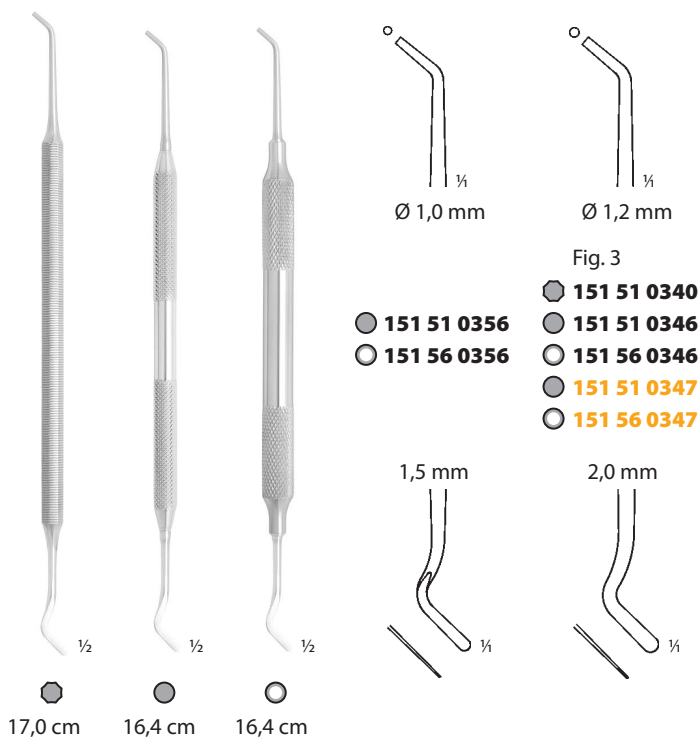
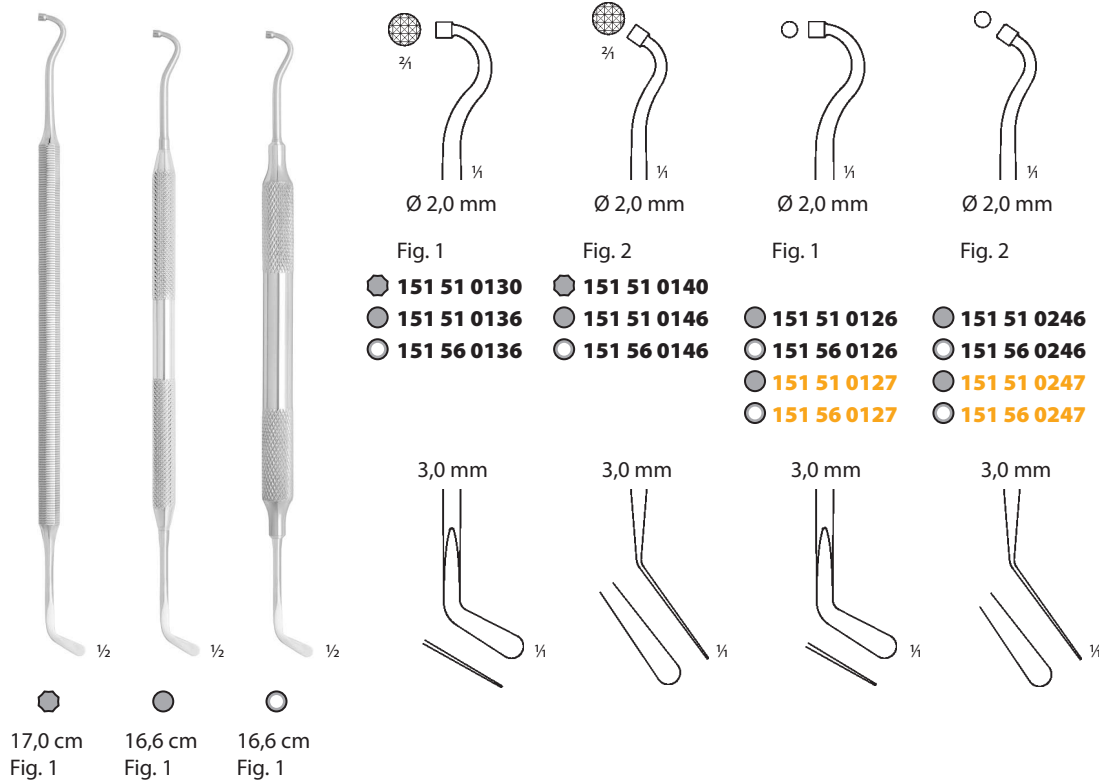

	osmihranné držátko – octagonal handle	5,5 mm
	plné držátko – round solid handle	Ø 6,0 mm
	duté držátko – hollow handle	Ø 8,0 mm

<b>151 5X XXXX</b>	nerez – stainless steel
<b>151 5X XXXX</b>	TiN povlak – TiN surface





HLADÍTKA SE CPÁTKEM  
SPATULAS – FILLING INSTRUMENTS

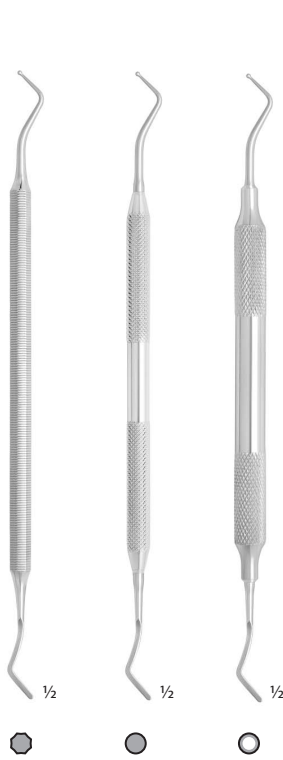

● 151 51 3050  
● 151 51 3056  
○ 151 56 3056  
16,6 cm



● 151 51 3070  
● 151 51 3076  
○ 151 56 3076  
16,8 cm



● 151 51 3080  
17,0 cm



● 151 51 3090  
17,0 cm

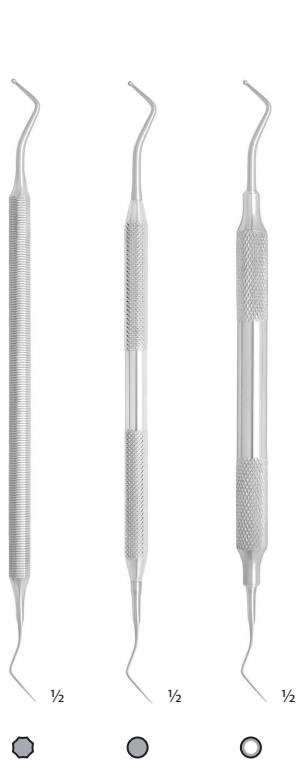

● 151 51 3250  
● 151 51 3256  
○ 151 56 3256  
16,4 cm



● 151 51 3260  
● 151 51 3266  
○ 151 56 3266  
16,4 cm



● 151 51 3270  
16,6 cm



● 151 51 3280  
● 151 51 3286  
○ 151 56 3286  
16,8 cm

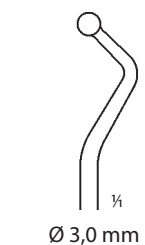

● 151 51 3290  
16,8 cm

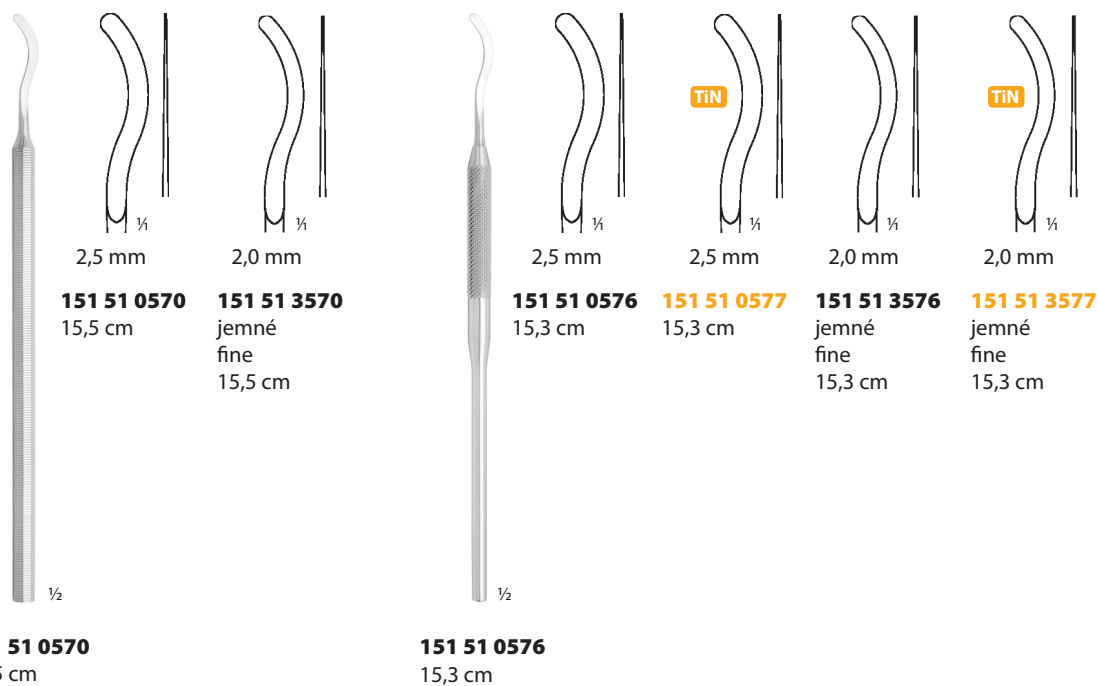
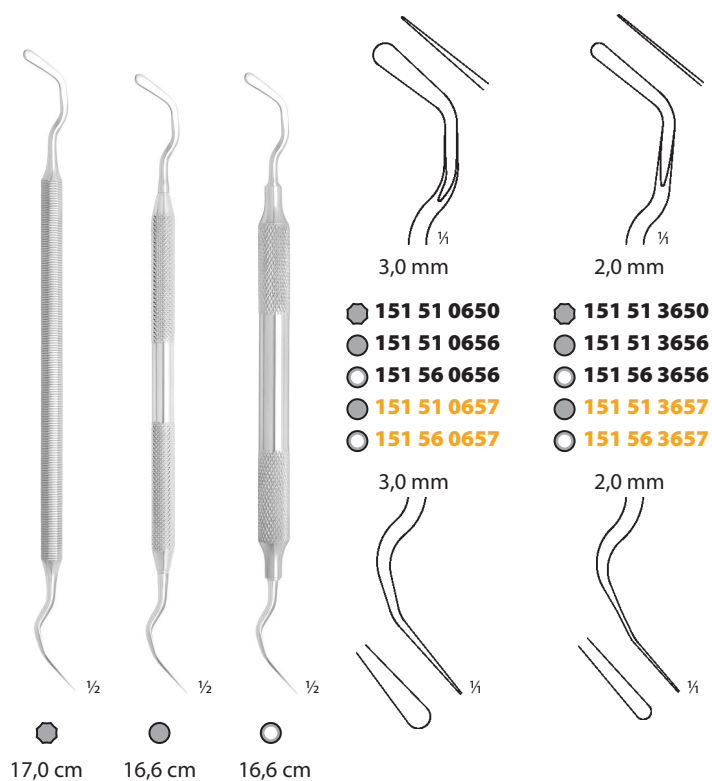
HLADÍTKA PRUŽNÁ  
SPATULAS FLEXIBLEHLADÍTKA 3× LOMENÁ  
SPATULAS 3× ANGLED

○ osmihranné držátko – octagonal handle	5,5 mm
● plné držátko – round solid handle	Ø 6,0 mm
○ duté držátko – hollow handle	Ø 8,0 mm

<b>151 5X XXXX</b>	nerez – stainless steel
<b>151 5X XXXX</b>	TiN povlak – TiN surface



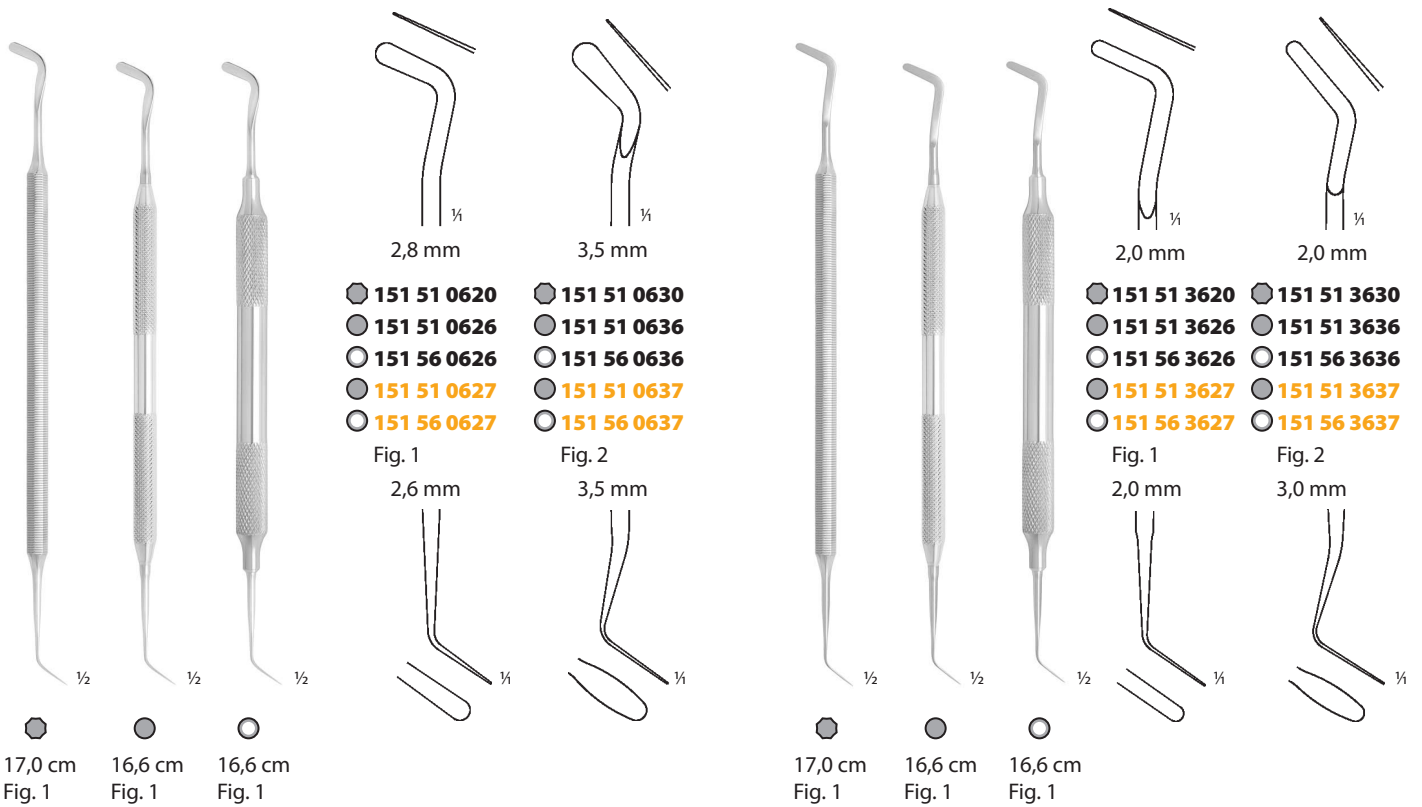

- 151 51 0620 ● 151 51 0630
- 151 51 0626 ● 151 51 0636
- 151 56 0626 ● 151 56 0636
- 151 51 0627 ● 151 51 0637
- 151 56 0627 ● 151 56 0637

- 151 51 3620 ● 151 51 3630
- 151 51 3626 ● 151 51 3636
- 151 56 3626 ● 151 56 3636
- 151 51 3627 ● 151 51 3637
- 151 56 3627 ● 151 56 3637

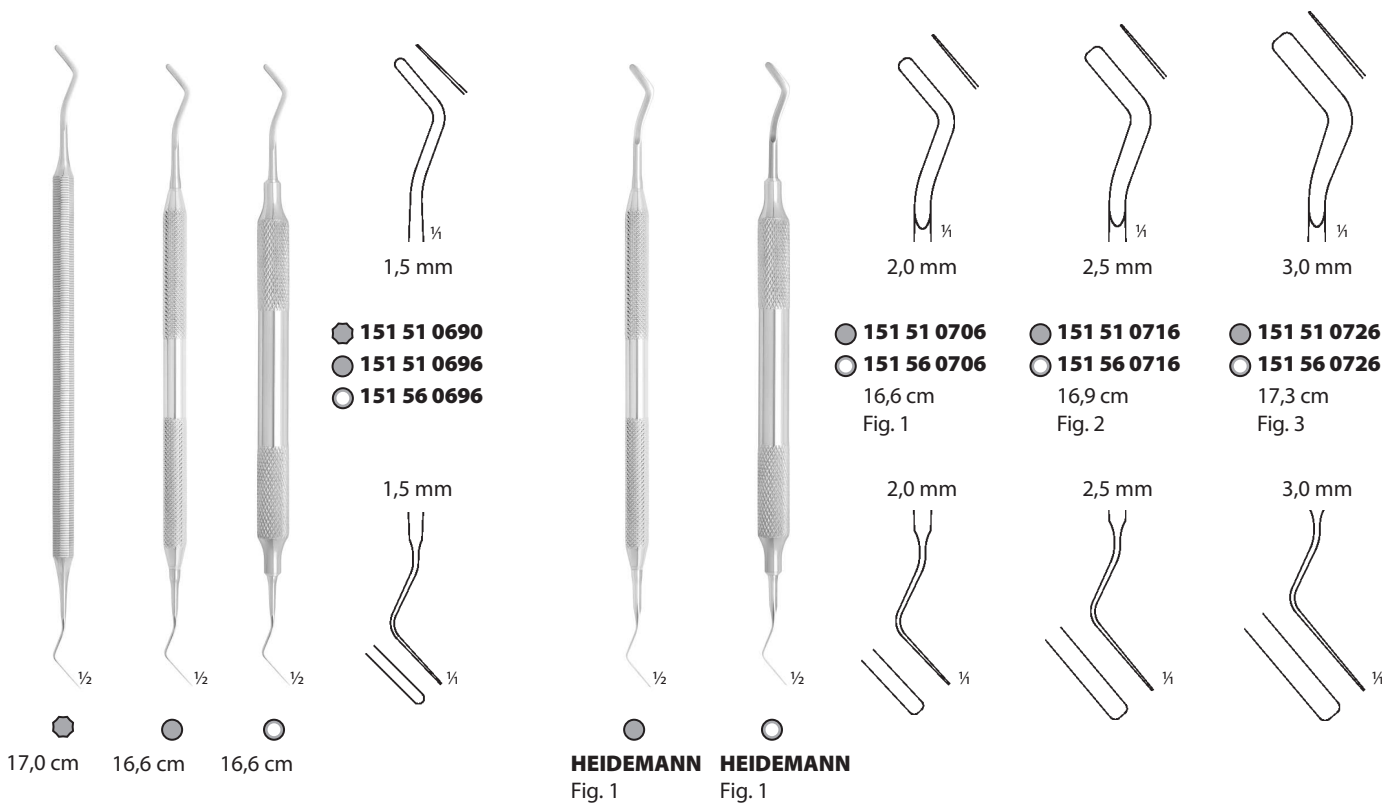

- 151 51 0690
- 151 51 0696
- 151 56 0696

- 151 51 0706 ● 151 51 0716 ● 151 51 0726
- 151 56 0706 ● 151 56 0716 ● 151 56 0726

● osmihranné držátko – octagonal handle	5,5 mm
● plné držátko – round solid handle	Ø 6,0 mm
● duté držátko – hollow handle	Ø 8,0 mm

151 5X XXXX	nerez – stainless steel
151 5X XXXX	TiN povlak – TiN surface



NÁSTROJE PRO VÝPLNĚ  
FILLING INSTRUMENTS

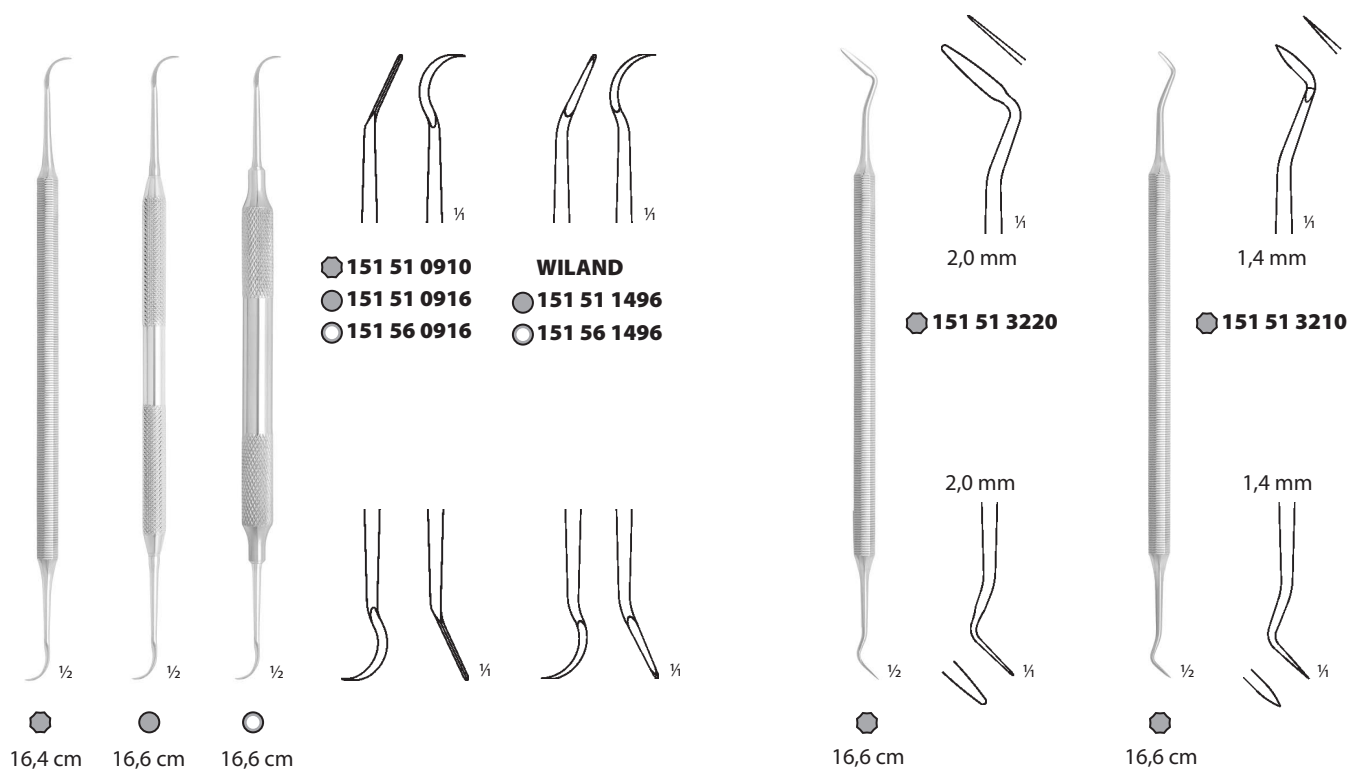
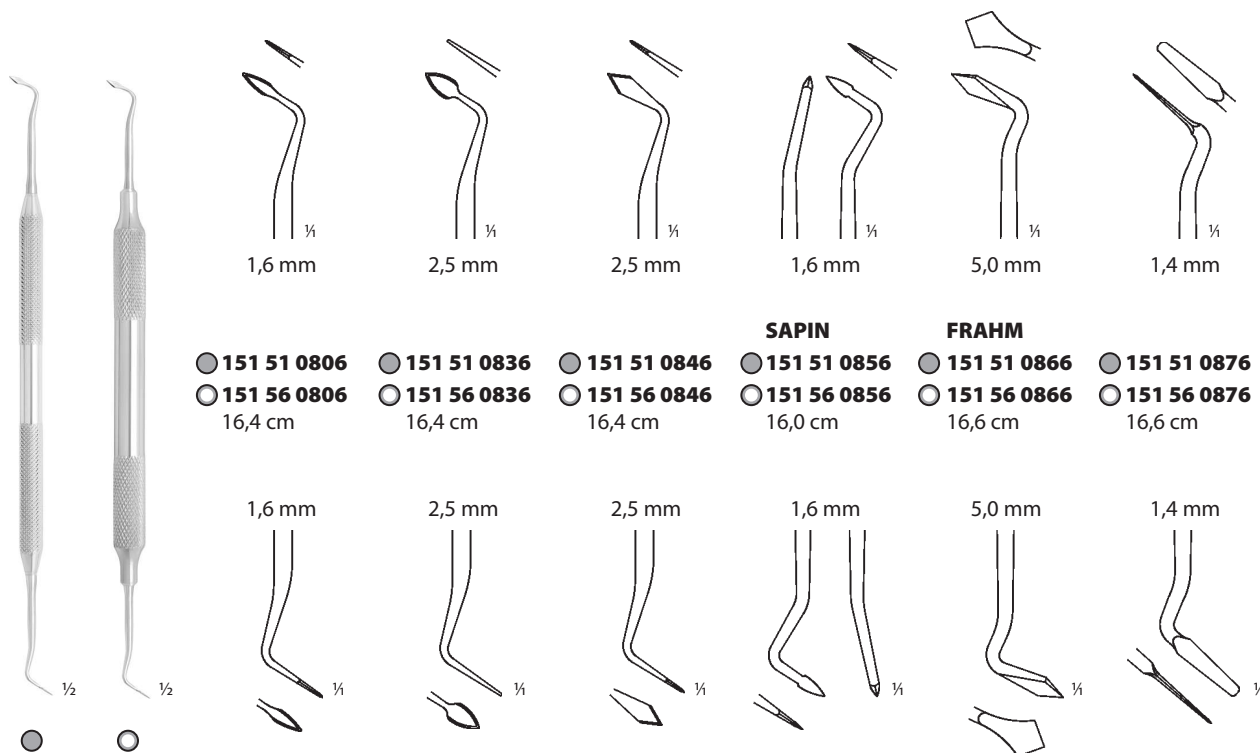

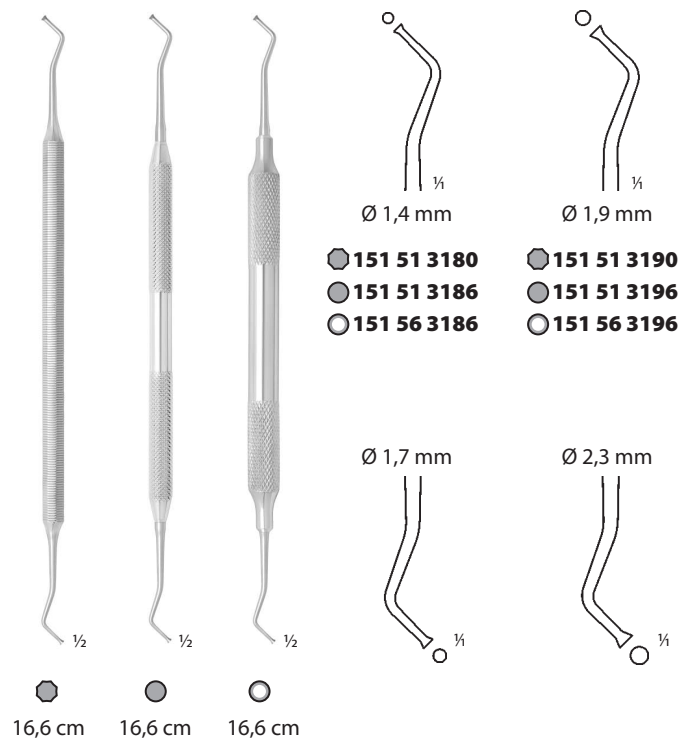
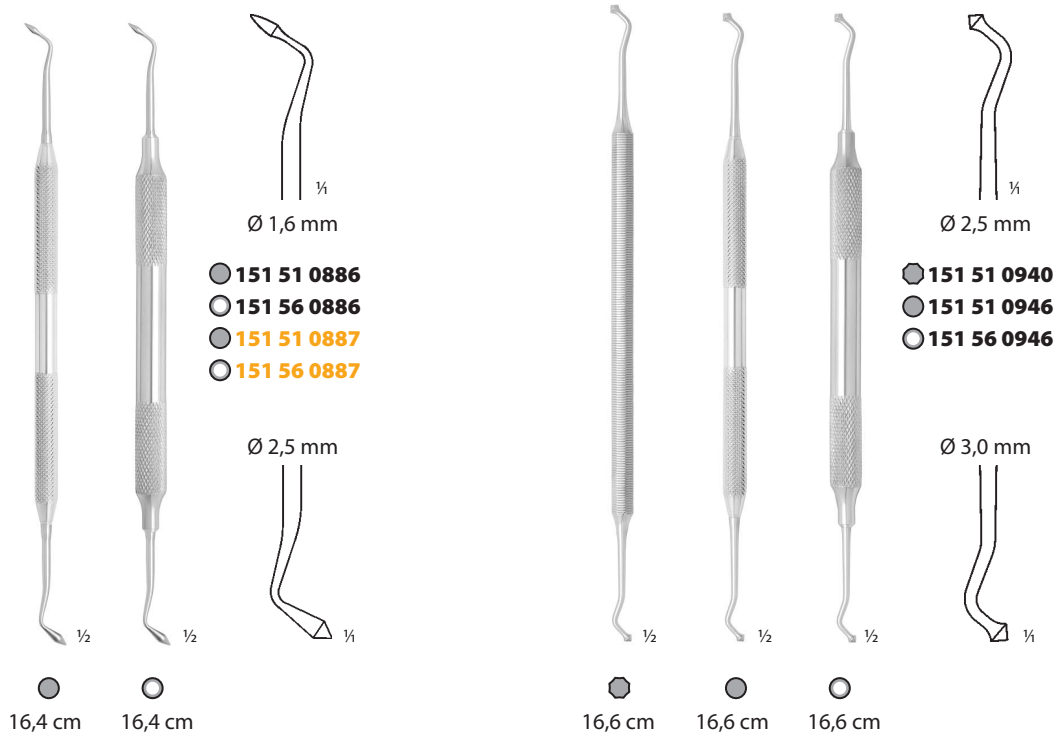

	osmihranné držátko – octagonal handle	5,5 mm
	plné držátko – round solid handle	Ø 6,0 mm
	duté držátko – hollow handle	Ø 8,0 mm

<b>151 5X XXXX</b>	nerez – stainless steel
<b>151 5X XXXX</b>	TiN povlak – TiN surface



NÁSTROJE PRO VÝPLNĚ  
FILLING INSTRUMENTS

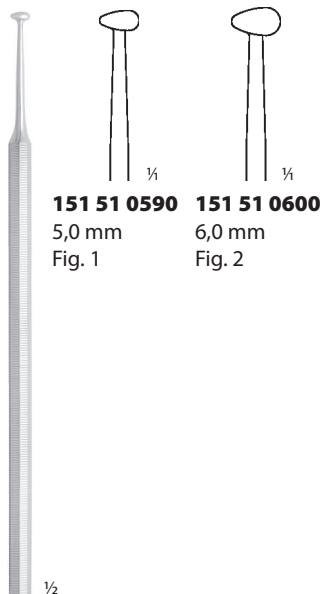

**151 51 0590**  
kapkovitý  
guttate profile  
15,5 cm

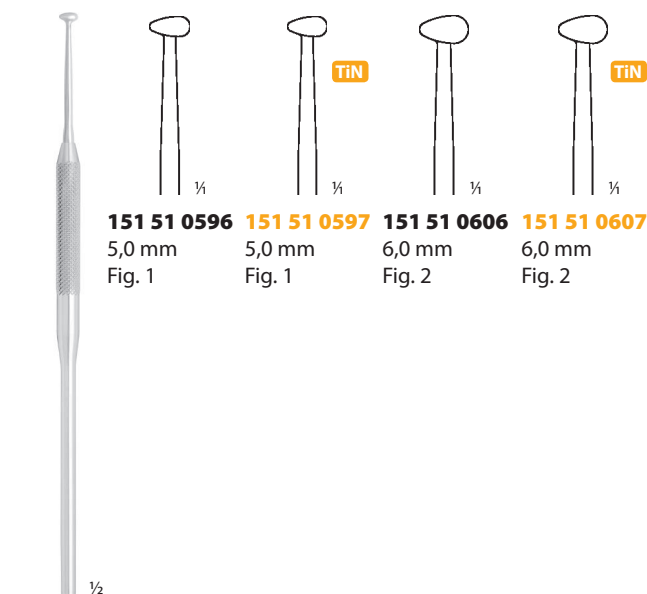

**151 51 0596**  
kapkovitý  
guttate profile  
15,3 cm

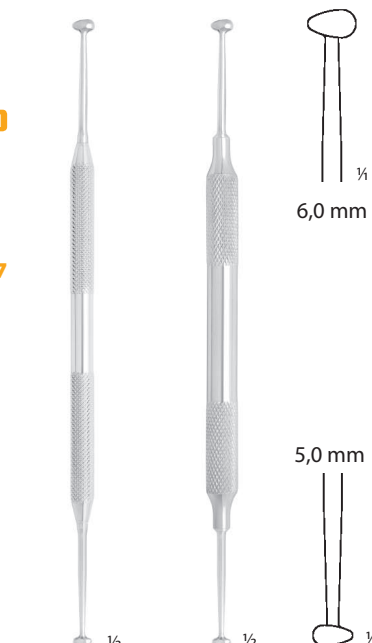

**151 51 0616** 16,6 cm  
**151 56 0616** 16,6 cm

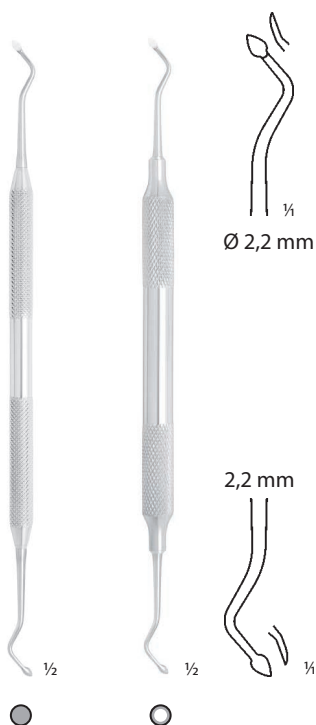

**151 51 0896** 16,8 cm  
**151 56 0896** 16,8 cm

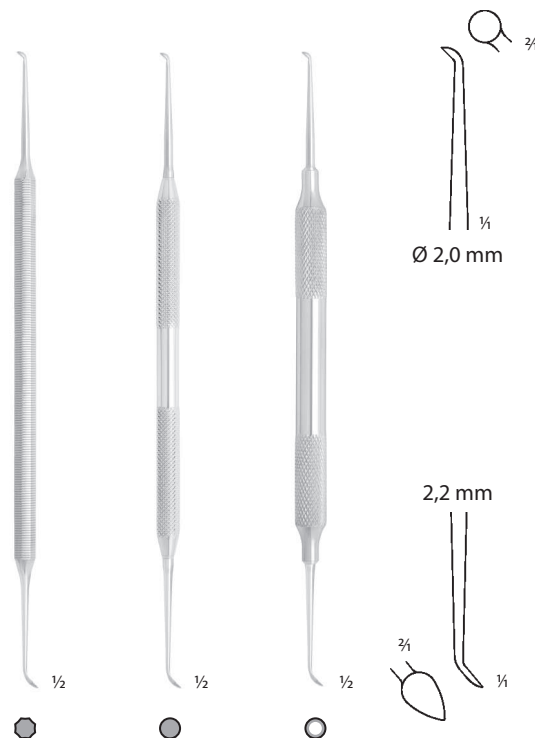

**DISCOID-CLEOID**  
**151 51 0930** 16,8 cm  
**151 51 0936** 16,8 cm  
**151 56 0936** 16,8 cm

○ osmihranné držátko – octagonal handle	5,5 mm
● plné držátko – round solid handle	Ø 6,0 mm
○ duté držátko – hollow handle	Ø 8,0 mm

<b>151 5X XXXX</b>	nerez – stainless steel
<b>151 5X XXXX</b>	TiN povlak – TiN surface



SEPARAČNÍ PÁSKY DIAMANTOVANÉ  
SEPARATION DIAMOND STRIPS

120 × 3 mm			
	<p><b>151 51 2020</b> D40 velmi jemná zrnitost very fine grain</p>	<p><b>151 51 2021</b> D64 jemná zrnitost fine grain</p>	<p><b>151 51 2022</b> D107 střední zrnitost medium grain</p>
120 × 4 mm			
	<p><b>151 51 2030</b> D40 velmi jemná zrnitost very fine grain</p>	<p><b>151 51 2031</b> D64 jemná zrnitost fine grain</p>	<p><b>151 51 2032</b> D107 střední zrnitost medium grain</p>
120 × 6 mm			
	<p><b>151 51 2040</b> D40 velmi jemná zrnitost very fine grain</p>	<p><b>151 51 2041</b> D64 jemná zrnitost fine grain</p>	<p><b>151 51 2042</b> D107 střední zrnitost medium grain</p>
120 × 8 mm			
	<p><b>151 51 2050</b> D40 velmi jemná zrnitost very fine grain</p>	<p><b>151 51 2051</b> D64 jemná zrnitost fine grain</p>	<p><b>151 51 2052</b> D107 střední zrnitost medium grain</p>

SEPARAČNÍ PÁSKY HLADKÉ  
SEPARATION STRIPS – SMOOTH

<p><b>151 51 1010</b> 120 × 6 mm</p>	<p><b>151 51 1020</b> 120 × 8 mm</p>

POZNÁMKY: Baleno po 100 ks.

NOTES: Packing of 100 pcs.

SVORKY NA PÁSKY  
STRIP CLAMPS

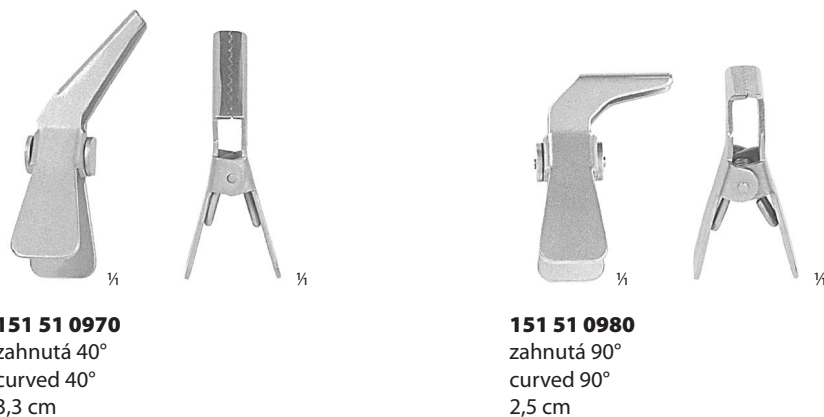

**151 51 0970**  
zahnutá 40°  
curved 40°  
3,3 cm

**151 51 0980**  
zahnutá 90°  
curved 90°  
2,5 cm

PISTOLE NA AMALGAM  
AMALGAM PISTOL

**151 51 0760**  
kovový píst  
metal piston  
15,0 cm



**151 51 0770**  
kovový píst  
metal piston  
13,0 cm



**151 51 0780**  
plastová  
plastic  
16,0 cm





Lopátka na mícháání  
Mixing spatula  
**121 52 0080**  
21,0 cm  
27 mm

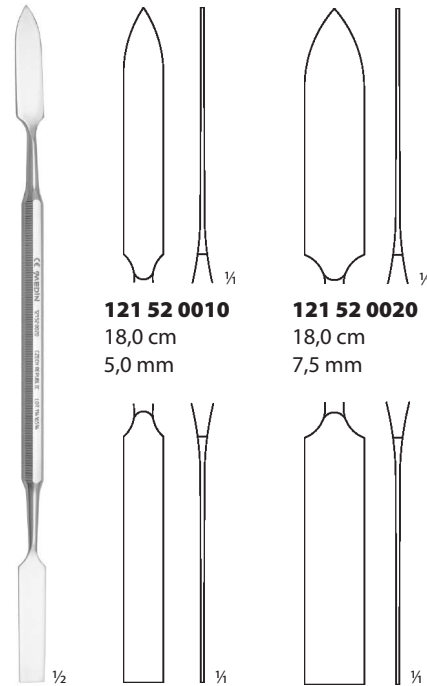

**121 52 0010**  
18,0 cm  
5,0 mm

**121 52 0020**  
18,0 cm  
7,5 mm

Lopátka na cement  
Cement spatula  
**121 52 0020**  
oboustranná  
double faced  
18,0 cm



**IVORY**  
**156 52 0010**  
malá  
small  
2,5 cm



**IVORY**  
**156 52 0020**  
střední  
medium  
3,6 cm



**IVORY**  
**156 52 0030**  
velká  
large  
3,5 cm

POZNÁMKY: Baleno po 20 ks.  
NOTES: Packing of 20 pcs.



**IVORY**  
Napínač matric  
Matrix retainer  
**156 52 0050**  
7,0 cm



**IVORY**  
Separátor  
Separator  
**156 52 0070**  
6,7 cm

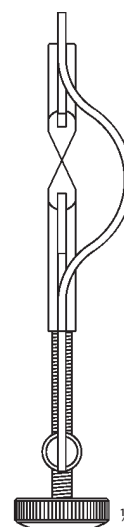



Matrice pásková  
Matrix band

<b>156 91 0001</b>	5 mm	1 m
<b>156 91 0002</b>	6 mm	1 m
<b>156 91 0003</b>	7 mm	1 m

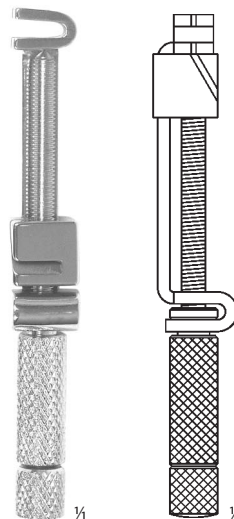

Napínač matric univerzální  
Universal retainer

**156 52 0300**  
6,4 cm

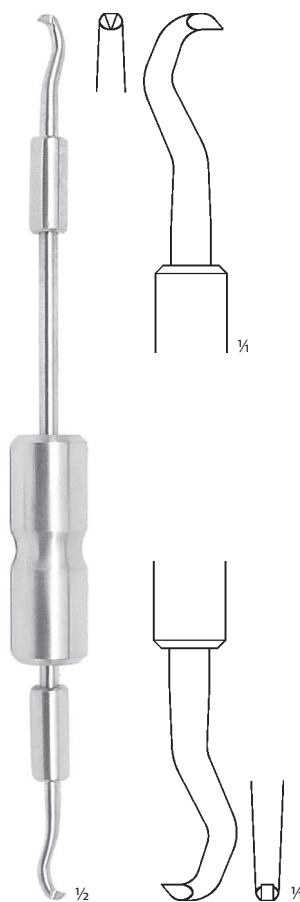

**123 50 0610**  
23,3 cm



D

**PARODONTOLOGIE**  
**PERIODONTIA**

<b>Sondy, pátridla</b>	Probes	101
<b>Kyrety</b>	Curettes	102–105
<b>Nástroje na zubní kámen</b>	Scalers	106–111
<b>Pilníky</b>	Files	112

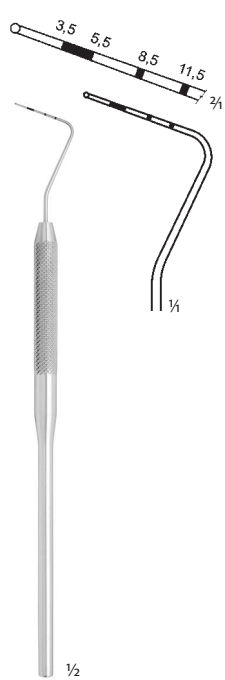

Sonda parodontologická  
Periodontal probe  
**133 50 0106**  
3,5; 5,5; 8,5; 11,5 mm  
WHO  
15,2 cm

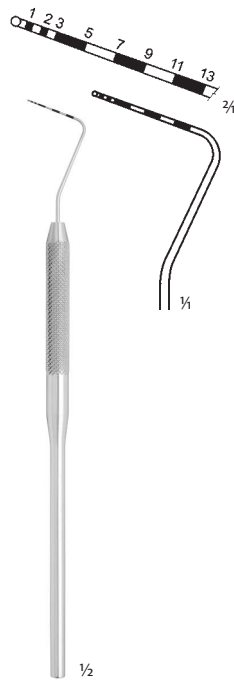

Sonda parodontologická  
Periodontal probe  
**133 50 0116**  
1; 2; 3; 5; 7; 9; 11; 13 mm  
15,2 cm



Explorer  
Explorer  
**133 51 0226**  
15,5 cm

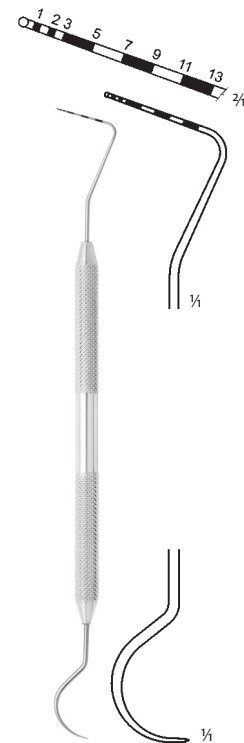

Sonda parodontologická s pátradlem  
Periodontal and dental probe  
**133 99 0177**  
15,7 cm

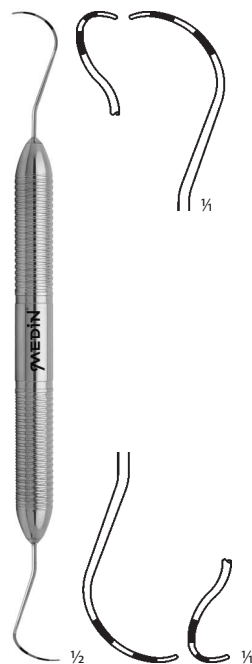

**NABERS**  
Furkační sonda  
Furcation probe  
**133 58 0230**  
3-6-9-12  
17,2 cm

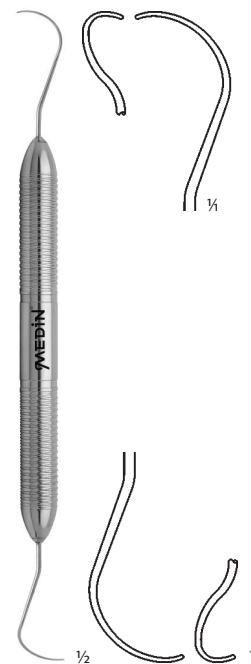

**NABERS**  
Furkační sonda nekalibrovaná  
Furcation probe non calibrated  
**133 58 0240**  
17,2 cm



**GRACEY 1/2**  
**126 58 0056**  
17,4 cm



**GRACEY 3/4**  
**126 58 0066**  
17,4 cm



**GRACEY 5/6**  
**126 58 0076**  
17,3 cm



**GRACEY 7/8**  
**126 58 0086**  
17,0 cm



**GRACEY 9/10**  
**126 58 0146**  
16,5 cm



**GRACEY 11/12**  
**126 58 0106**  
17,2 cm



**GRACEY 13/14**  
**126 58 0116**  
17,0 cm



**GRACEY 15/16**  
**126 58 0126**  
17,1 cm

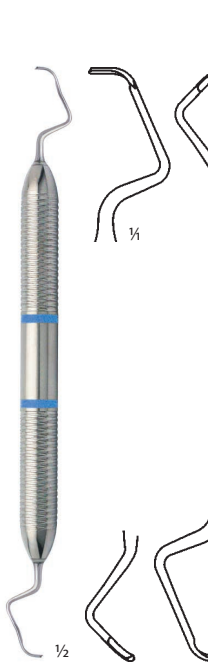

**GRACEY 17/18**  
**126 58 0136**  
15,6 cm





**MINI GRACEY 1/2**  
**126 58 1056**  
17,6 cm



**MINI GRACEY 3/4**  
**126 58 1066**  
17,4 cm



**MINI GRACEY 5/6**  
**126 58 1076**  
17,5 cm



**MINI GRACEY 7/8**  
**126 58 1086**  
17,1 cm



**MINI GRACEY 9/10**  
**126 58 1146**  
16,7 cm



**MINI GRACEY 11/12**  
**126 58 1106**  
17,4 cm



**MINI GRACEY 13/14**  
**126 58 1116**  
17,4 cm



**MINI GRACEY 15/16**  
**126 58 1126**  
17,2 cm

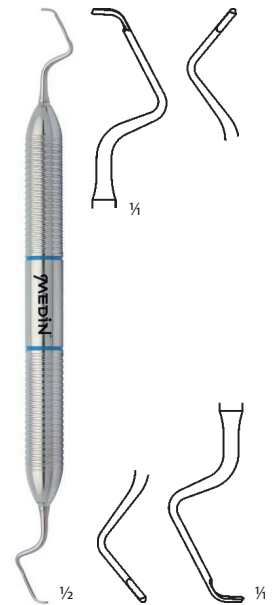

**MINI GRACEY 17/18**  
**126 58 1136**  
15,8 cm



Soubor parodontologických nástrojů, set 1  
Set of periodontal instruments, set 1

**139 50 0770**

		ks / pcs
<b>126 58 0056</b>	Gracey kyreta 1/2; 17,4 cm	1
<b>126 58 0066</b>	Gracey kyreta 3/4; 17,4 cm	1
<b>126 58 0076</b>	Gracey kyreta 5/6; 17,3 cm	1
<b>126 58 0086</b>	Gracey kyreta 7/8; 17,0 cm	1
<b>126 58 0096</b>	Scaler oboustranný; 16,7 cm	1
<b>126 58 0106</b>	Gracey kyreta 11/12; 17,2 cm	1
<b>126 58 0116</b>	Gracey kyreta 13/14; 17,0 cm	1
<b>126 58 0126</b>	Gracey kyreta 15/16; 17,1 cm	1
<b>126 58 0136</b>	Gracey kyreta 17/18; 15,6 cm	1
<b>126 58 0146</b>	Gracey kyreta 9/10; 16,5 cm	1

Soubor parodontologických nástrojů, set 2  
Set of periodontal instruments, set 2

**139 50 0780**

		ks / pcs
<b>126 58 0076</b>	Gracey kyreta 5/6; 17,3 cm	1
<b>126 58 0086</b>	Gracey kyreta 7/8; 17,0 cm	1
<b>126 58 0096</b>	Scaler oboustranný; 16,7 cm	1
<b>126 58 0106</b>	Gracey kyreta 11/12; 17,2 cm	1
<b>126 58 0116</b>	Gracey kyreta 13/14; 17,0 cm	1

Soubor parodontologických nástrojů mini, set 1  
Set of mini periodontal instruments, set 1

**139 50 0810**

		ks / pcs
<b>126 58 1056</b>	Mini Gracey kyreta 1/2; 17,6 cm	1
<b>126 58 1066</b>	Mini Gracey kyreta 3/4; 17,4 cm	1
<b>126 58 1076</b>	Mini Gracey kyreta 5/6; 17,5 cm	1
<b>126 58 1086</b>	Mini Gracey kyreta 7/8; 17,1 cm	1
<b>126 58 0096</b>	Scaler oboustranný; 16,7 cm	1
<b>126 58 1106</b>	Mini Gracey kyreta 11/12; 17,4 cm	1
<b>126 58 1116</b>	Mini Gracey kyreta 13/14; 17,4 cm	1
<b>126 58 1126</b>	Mini Gracey kyreta 15/16; 17,2 cm	1
<b>126 58 1136</b>	Mini Gracey kyreta 17/18; 15,8 cm	1
<b>126 58 1146</b>	Mini Gracey kyreta 9/10; 16,7 cm	1



Furkační kyreta  
Furcation curette  
**124 58 0010**  
17,2 cm



Furkační kyreta  
Furcation curette  
**124 58 0020**  
17,6 cm

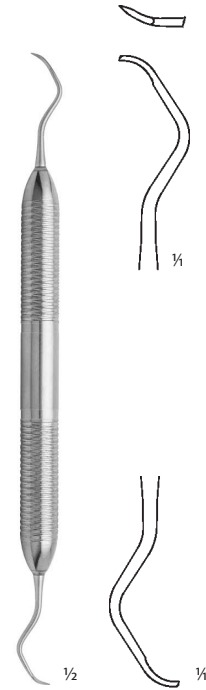

Scaler  
Scaler  
**126 58 0096**  
16,7 cm

PŘÍSLUŠENSTVÍ PRO PARODONTOLOGII  
PERIODONTAL ACCESSORIES



Brousek na ostření kyret  
Sharpening stone for currettes  
**126 91 0162**



Testovací tyčinka PMMA  
Plastic test stick  
**126 53 0010**  
80 mm

NÁSTROJE NA ZUBNÍ KÁMEN  
SCALERS



**147 51 0010**  
15,5 cm

**147 51 0018**  
15,5 cm

**147 51 0016**  
15,5 cm

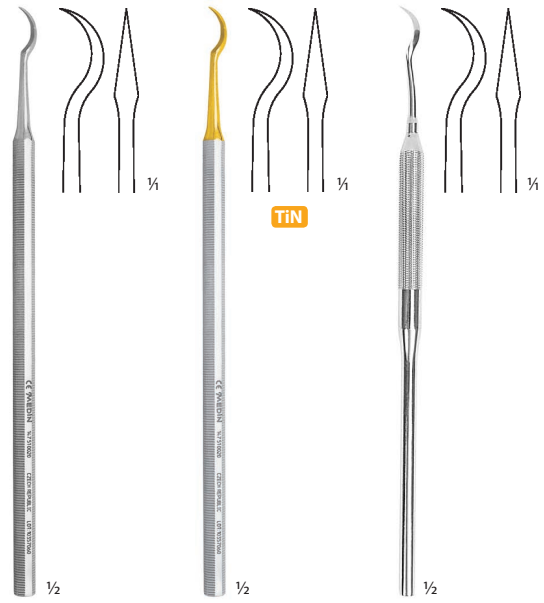

**147 51 0020**  
15,5 cm

**147 51 0028**  
15,5 cm

**147 51 0026**  
15,5 cm

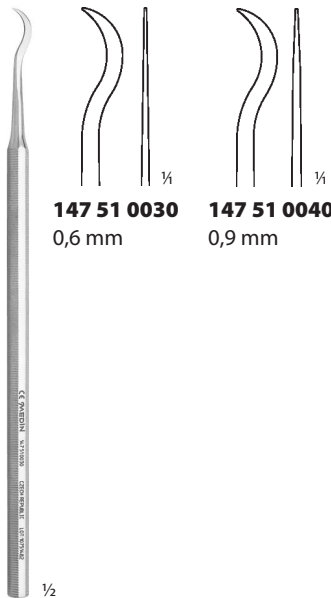

**147 51 0030**  
0,6 mm

**147 51 0040**  
0,9 mm

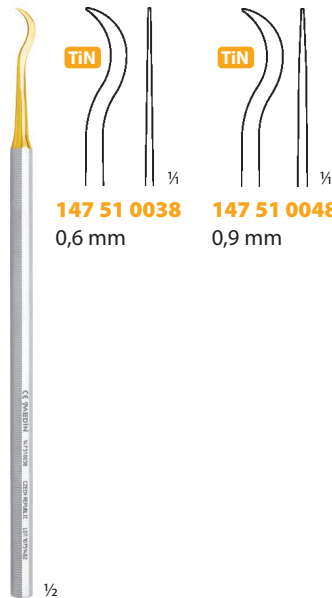

**147 51 0038**  
0,6 mm

**147 51 0048**  
0,9 mm

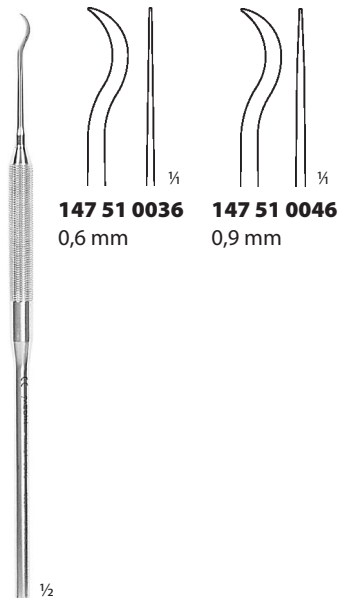

**147 51 0036**  
0,6 mm

**147 51 0046**  
0,9 mm

**147 51 0030**  
15,5 cm

**147 51 0038**  
15,5 cm

**147 51 0036**  
15,5 cm



**147 51 0060**  
2× lomený  
double angled  
15,5 cm

**147 51 0068**  
2× lomený  
double angled  
15,5 cm

**147 51 0066**  
2× lomený  
double angled  
15,5 cm

ŠKRABKY NA ZUBNÍ KÁMEN  
SCALERS

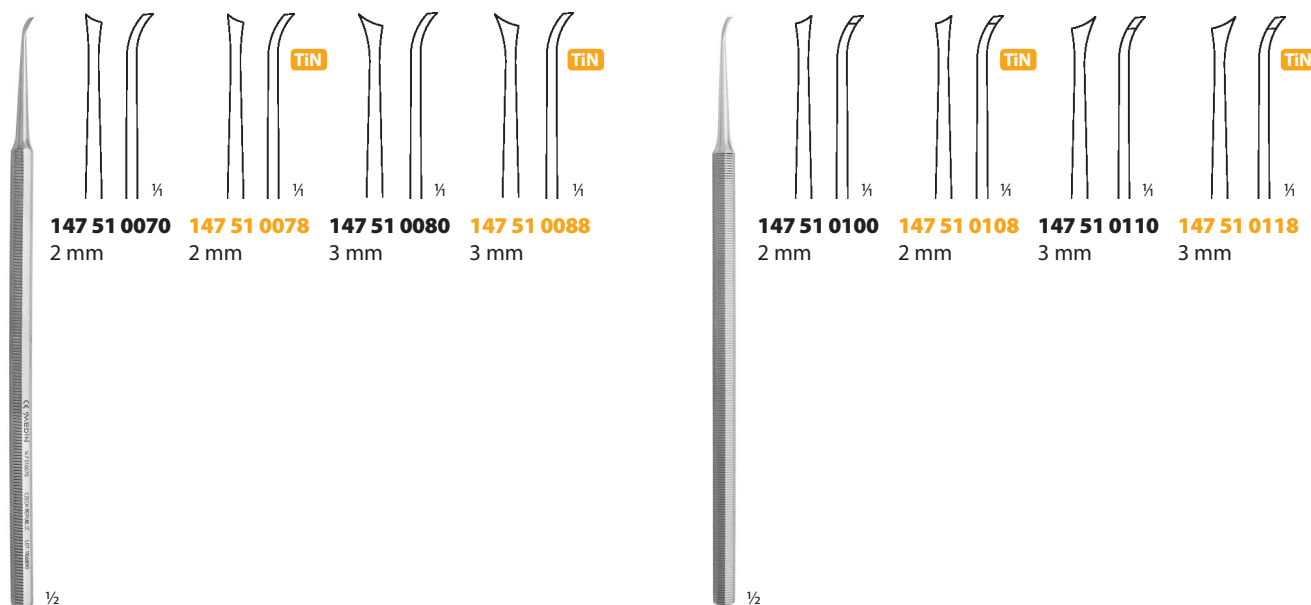

**147 51 0070**  
pravá  
right  
15,5 cm

**147 51 0100**  
levá  
left  
15,5 cm

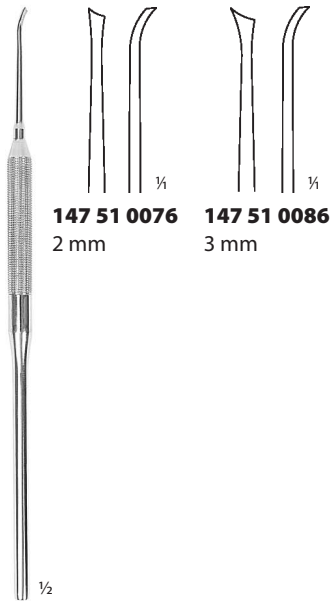
ŠKRABKY NA ZUBNÍ KÁMEN  
SCALERS

**147 51 0076**  
2 mm

**147 51 0086**  
3 mm

**147 51 0076**  
pravá  
right  
15,5 cm

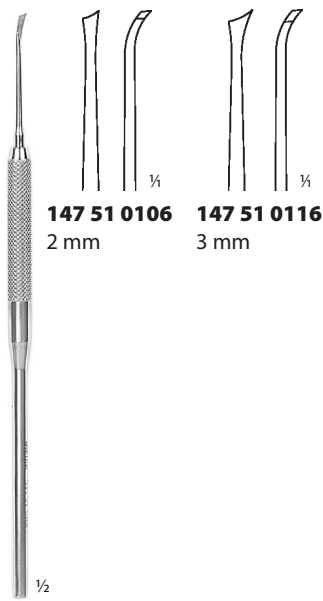

**147 51 0106**  
2 mm

**147 51 0116**  
3 mm

**147 51 0106**  
levá  
left  
15,5 cm



1 mm

**BLACK**  
**147 51 0336**  
levá  
left  
15,5 cm



1 mm

**BLACK**  
**147 51 0346**  
pravá  
right  
15,5 cm

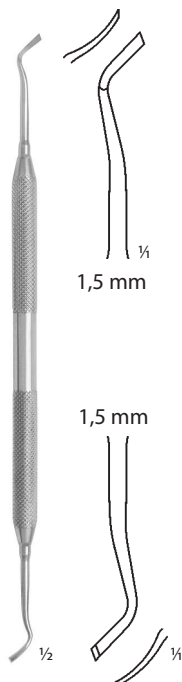
ZEŠIKMOVAČE GINGIVÁLNÍCH OKRAJŮ  
GINGIVAL MARGIN TRIMMERS

1,5 mm

1,5 mm

**147 51 0806**  
distální  
distal  
16,6 cm

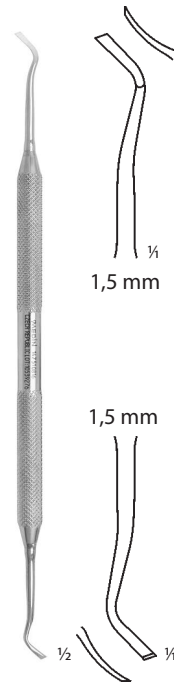

1,5 mm

1,5 mm

**147 51 0816**  
meziální  
mesial  
16,5 cm

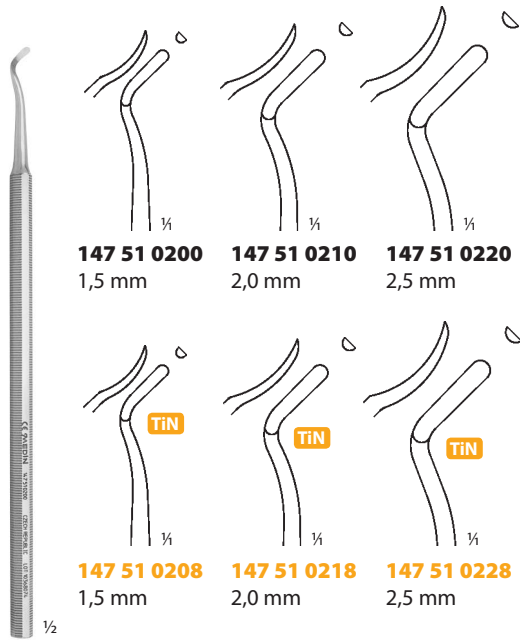

**147 51 0200**  
pravý  
right  
15,5 cm

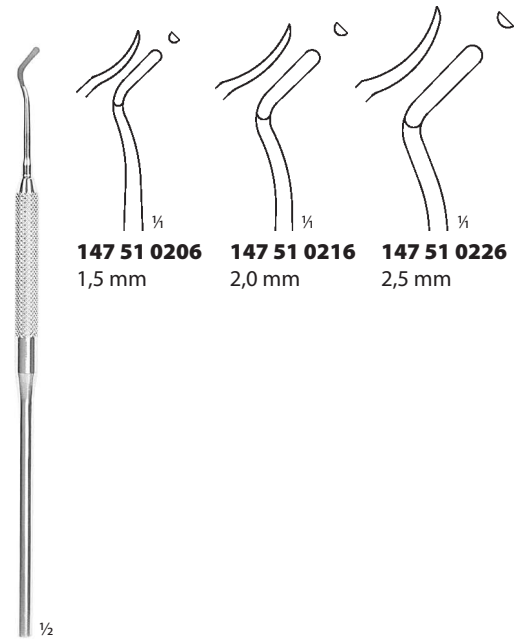

**147 51 0206**  
pravý  
right  
15,5 cm

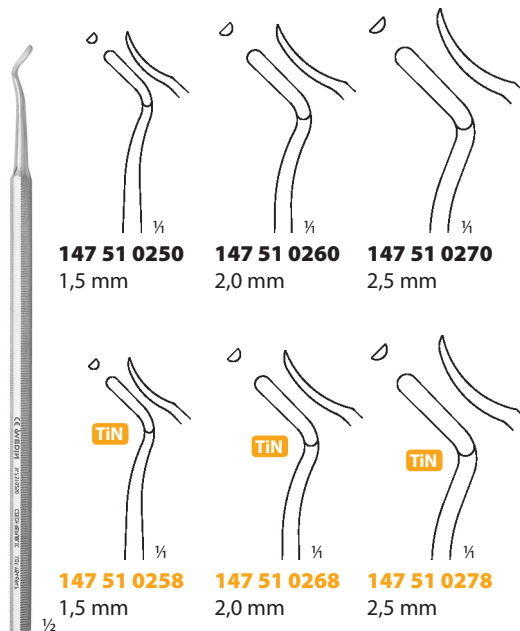

**147 51 0250**  
levý  
left  
15,5 cm

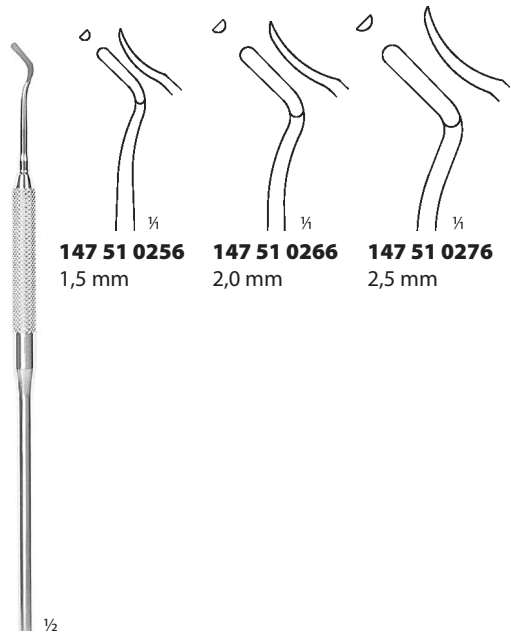

**147 51 0256**  
levý  
left  
15,5 cm

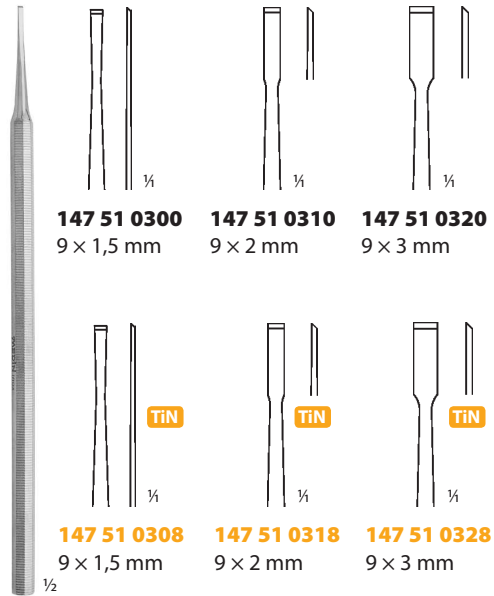
DLÁTKA NA SKLOVINU  
ENAMEL CHISELS

**BLACK**  
**147 51 0300**  
15,5 cm

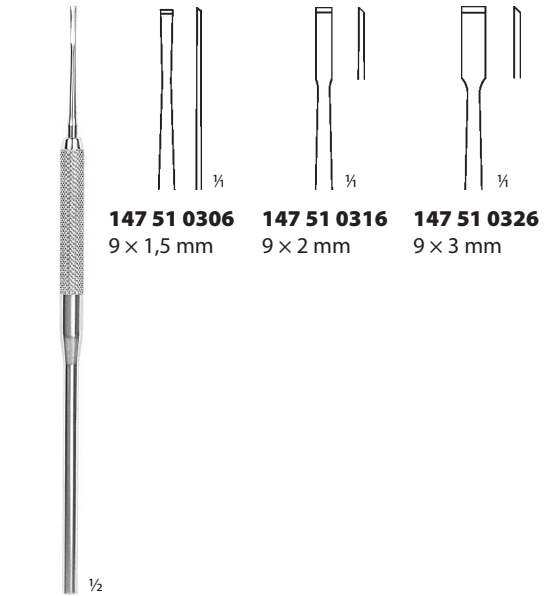

**BLACK**  
**147 51 0306**  
15,5 cm

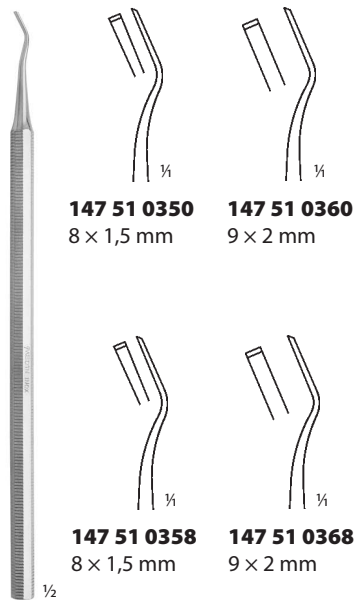

**BLACK**  
**147 51 0350**  
15,5 cm

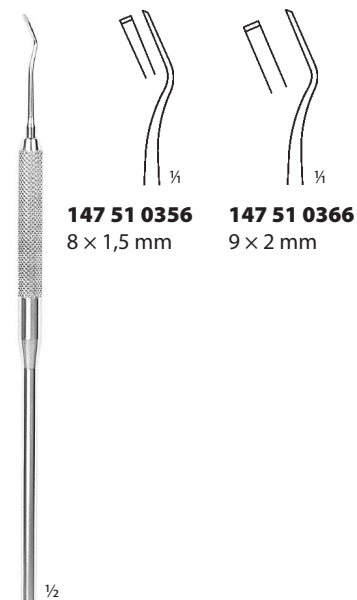

**BLACK**  
**147 51 0356**  
15,5 cm



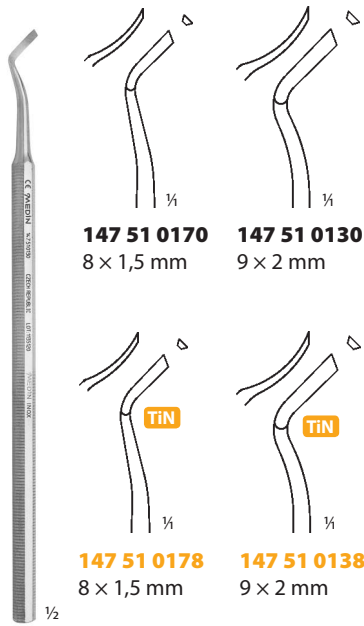

**147 51 0170**  
8 × 1,5 mm

**147 51 0130**  
9 × 2 mm

**147 51 0178**  
8 × 1,5 mm

**147 51 0138**  
9 × 2 mm

**BLACK**  
**147 51 0130**  
pravá  
right  
15,5 cm

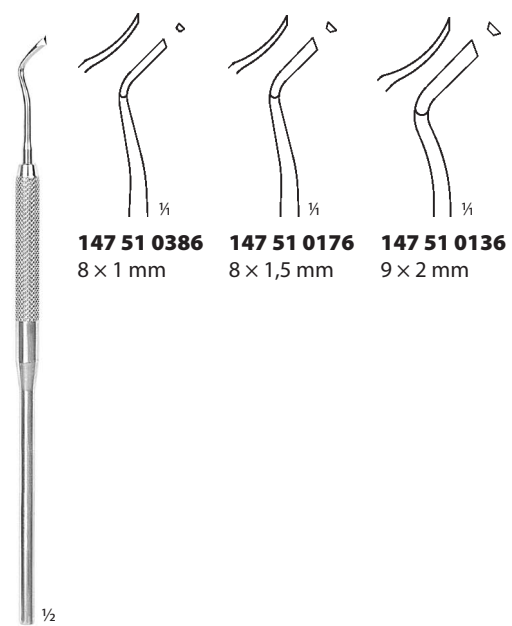

**147 51 0386**  
8 × 1 mm

**147 51 0176**  
8 × 1,5 mm

**147 51 0136**  
9 × 2 mm

**BLACK**  
**147 51 0136**  
pravá  
right  
15,5 cm

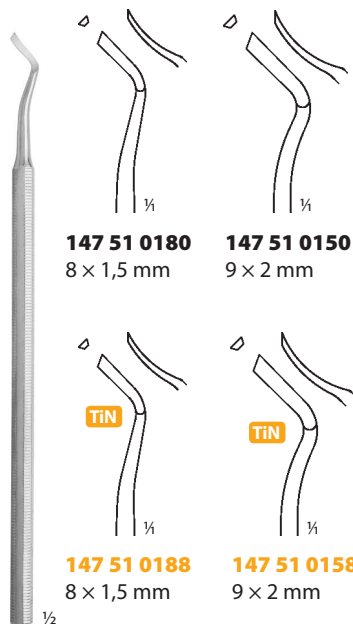

**147 51 0180**  
8 × 1,5 mm

**147 51 0150**  
9 × 2 mm

**147 51 0188**  
8 × 1,5 mm

**147 51 0158**  
9 × 2 mm

**BLACK**  
**147 51 0150**  
levá  
left  
15,5 cm

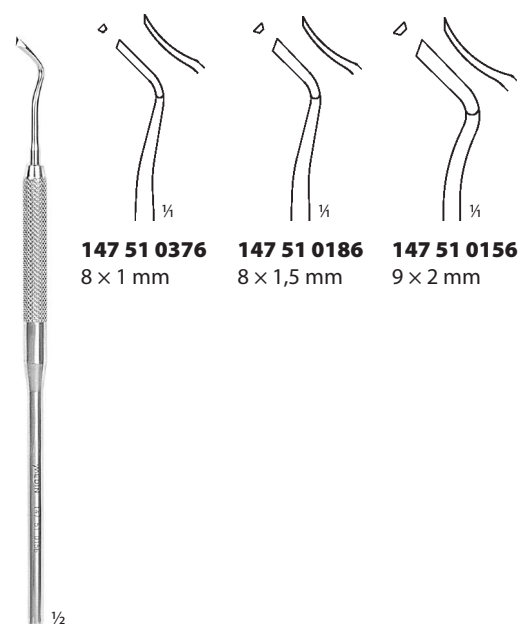

**147 51 0376**  
8 × 1 mm

**147 51 0186**  
8 × 1,5 mm

**147 51 0156**  
9 × 2 mm

**BLACK**  
**147 51 0156**  
levá  
left  
15,5 cm

PILNÍKY DIAMANTOVANÉ – ZRNITOST STŘEDNÍ  
DIAMOND FILES – GRIT MEDIUM

**127 51 1206**  
15,0 cm  
2 × 8 mm  
Fig. 1



**127 51 1216**  
15,0 cm  
2 × 8 mm  
Fig. 2



**127 51 1226**  
15,2 cm  
2 × 8 mm  
Fig. 3



**127 51 1236**  
15,2 cm  
2 × 8 mm  
Fig. 4



**127 51 1306**  
jehlový  
needle  
15,0 cm



**127 51 1206**  
15,0 cm

PILNÍKY DIAMANTOVANÉ – ZRNITOST HRUBÁ  
DIAMOND FILES – GRIT COARSE

**127 51 1316**  
15,0 cm

**127 51 1316**  
15,0 cm  
2 × 8 mm  
Fig. 5



**127 51 1326**  
15,0 cm  
2 × 8 mm  
Fig. 6



**127 51 1336**  
15,0 cm  
2 × 8 mm  
Fig. 7



**127 51 1346**  
15,0 cm  
2 × 8 mm  
Fig. 8





E

**ORTODONCIE**  
ORTHODONTICS

<b>Kleště úchopné</b>	Grasping Forceps	115
<b>Kleště štípací</b>	Cutting Rongeurs	115
<b>Kleště úchopné</b>	Grasping Forceps	116–118



Kleště na kelímky  
Crucible forceps  
**117 52 0770**  
50,0 cm

1/3



Kleště na kelímky  
Crucible forceps  
**117 52 0780**  
27,5 cm

1/3

KLEŠTĚ ŠTÍPACÍ NA DRÁT  
WIRE CUTTING FORCEPS



**116 91 0001**

14,5 cm

pro měkký drát do průměru 1,5 mm  
for soft wires up to diameter 1,5 mm

pro tvrdý drát do průměru 1,0 mm  
for hard wires up to diameter 1,0 mm

1/2

KLEŠTĚ LABORATORNÍ OHÝBACÍ  
LABORATORY BENDING FORCEPS**117 52 0700**

13,5 cm

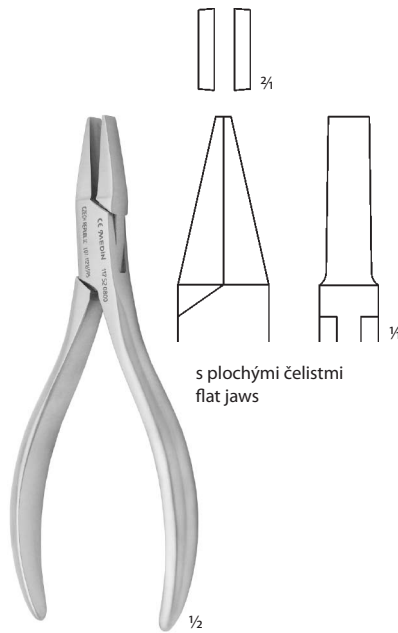
pro tvrdý drát do průměru 0,8 mm  
for hard wires up to diameter 0,8 mm**117 52 0800**

13,4 cm

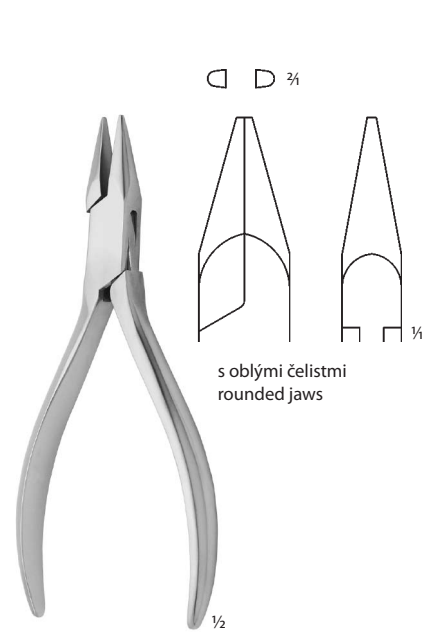
pro tvrdý drát do průměru 1,2 mm  
for hard wires up to diameter 1,2 mm**117 52 0810**

13,4 cm

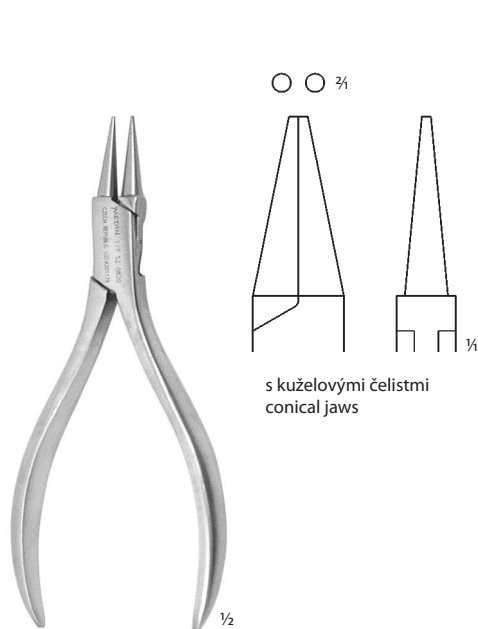
pro tvrdý drát do průměru 1,1 mm  
for hard wires up to diameter 1,1 mm**117 52 0820**

13,4 cm

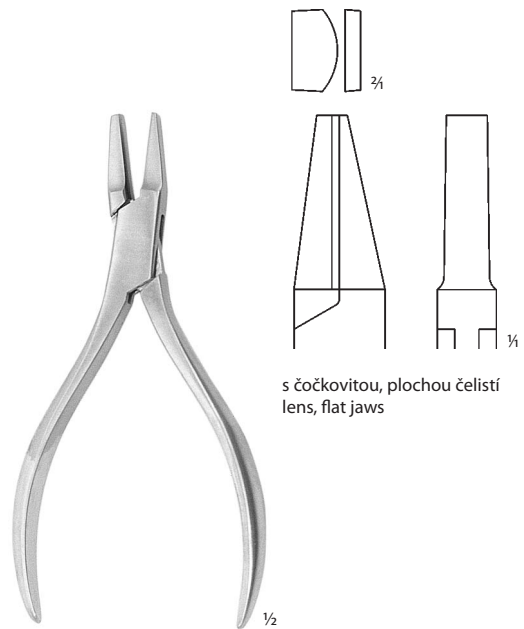
pro tvrdý drát do průměru 1,2 mm  
for hard wires up to diameter 1,2 mm**117 52 0830**

13,4 cm

pro tvrdý drát do průměru 1,4 mm  
for hard wires up to diameter 1,4 mm

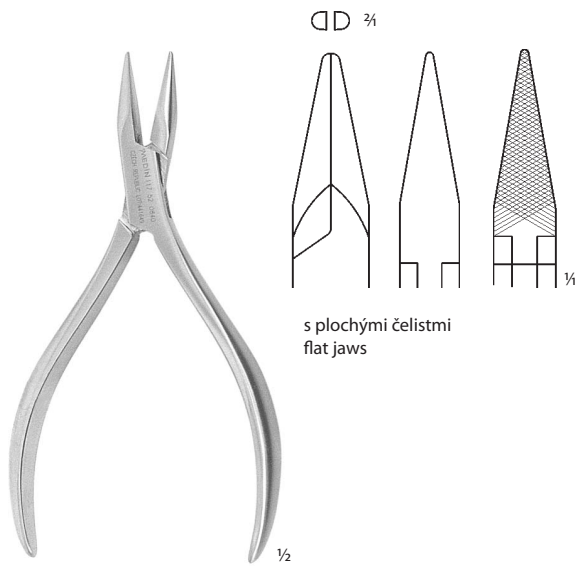

**117 52 0840**  
13,5 cm  
pro tvrdý drát do průměru 1,2 mm  
for hard wires up to diameter 1,2 mm  
Fig. 1

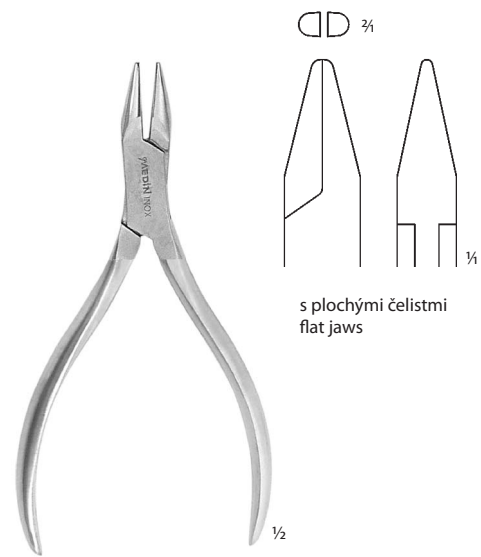

**117 52 0870**  
13,0 cm  
pro tvrdý drát do průměru 1,2 mm  
for hard wires up to diameter 1,2 mm  
Fig. 4

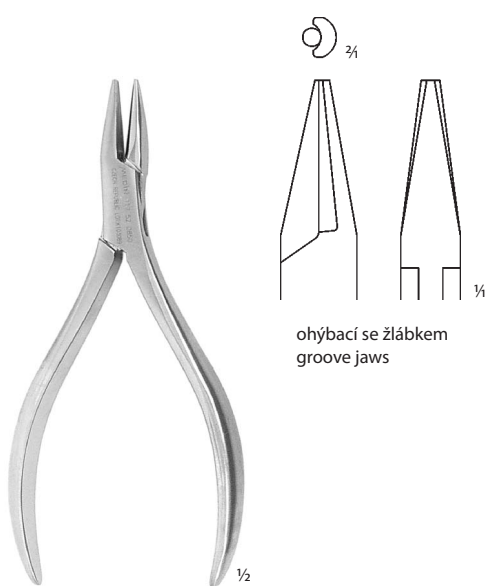

**117 52 0850**  
13,3 cm  
pro tvrdý drát do průměru 0,8 mm  
for hard wires up to diameter 0,8 mm  
Fig. 2

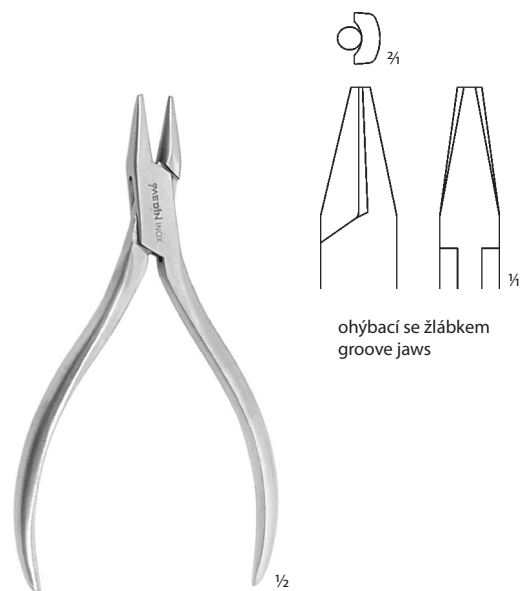

**117 52 0860**  
13,0 cm  
pro tvrdý drát do průměru 0,9 mm  
for hard wires up to diameter 0,9 mm  
Fig. 3

KLEŠTĚ LABORATORNÍ OHÝBACÍ  
LABORATORY BENDING FORCEPS**117 52 0880**

12,2 cm

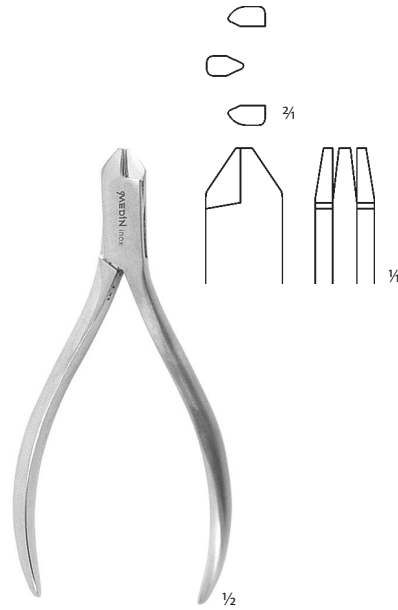
pro tvrdý drát do průměru 0,7 mm  
for hard wires up to diameter 0,7 mm  
Fig. 5**117 52 0890**

11,9 cm

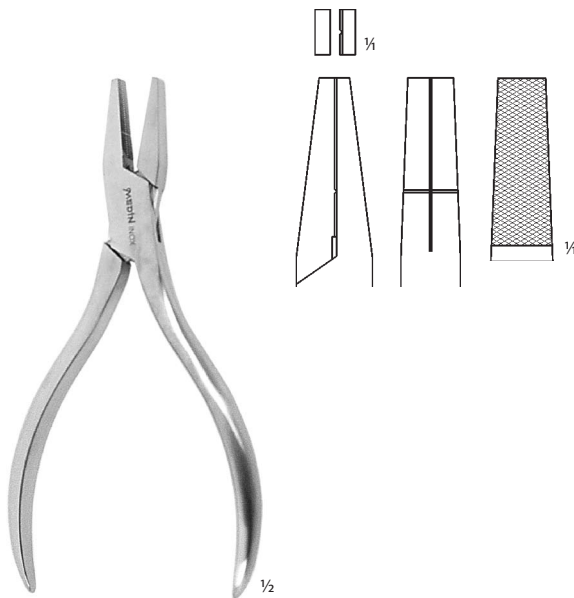
pro tvrdý drát do průměru 0,9 mm  
for hard wires up to diameter 0,9 mm  
Fig. 6**117 52 1000**utahovací  
tightening

13,6 cm

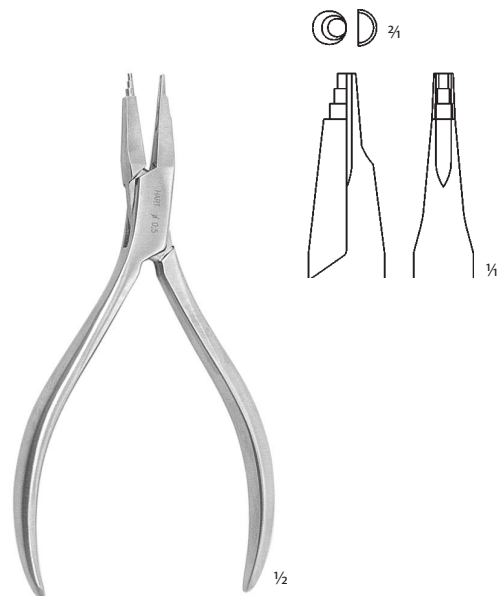
pro tvrdý drát do průměru 1,2 mm  
for hard wires up to diameter 1,2 mm**117 52 1010**

13,6 cm

pro tvrdý drát do průměru 1,5 mm  
for hard wires up to diameter 1,5 mm



F

LABORATOŘ  
LABORATORY



<b>Pinzety</b>	Forceps	121
<b>Nůžky</b>	Scissors	122
<b>Pilky</b>	Saws	122
<b>Lopatky</b>	Spatulas	123
<b>Lžičky laboratorní</b>	Laboratory Spoons	123
<b>Stomatologické soubory</b>	Stomatological Sets	124
<b>Nástroje modelovací</b>	Modelling Instruments	125–127
<b>Kladiva</b>	Mallets	128
<b>Kyvety, třmeny, lisy</b>	Flasks, Claps, Presses	129–130
<b>Pomůcky pro lití</b>	Casting Devices	131–132
<b>Zubní náhrady</b>	Tooth Replacement	132
<b>Otiskovací lžice</b>	Impression Trays	133–134



Pinzeta laboratorní  
Cross-action forceps  
**114 52 0100**  
15,3 cm



Pinzeta laboratorní  
Cross-action forceps  
**114 52 0101**  
15,3 cm

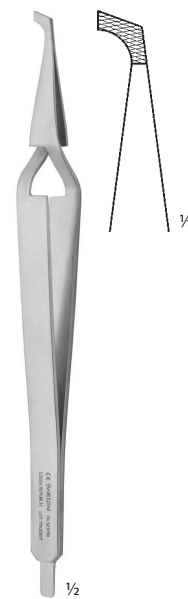

Pinzeta zkřížená se šroubovákem  
Cross-action forceps with screwdriver  
**114 52 0110**  
15,5 cm

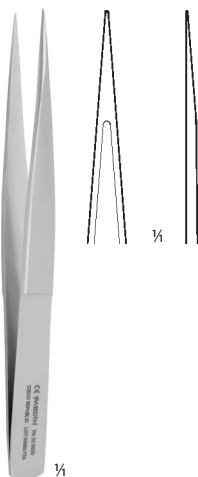

Pinzeta laboratorní  
Laboratory forceps  
**114 52 0020**  
hrotnatá  
pointed  
12,5 cm



Pinzeta laboratorní  
Laboratory forceps  
**114 52 0030**  
12,5 cm



**114 52 0040**  
jemná  
fine  
12,5 cm  
0,4 mm



**114 52 0050**  
jemná  
fine  
11,0 cm  
0,3 mm

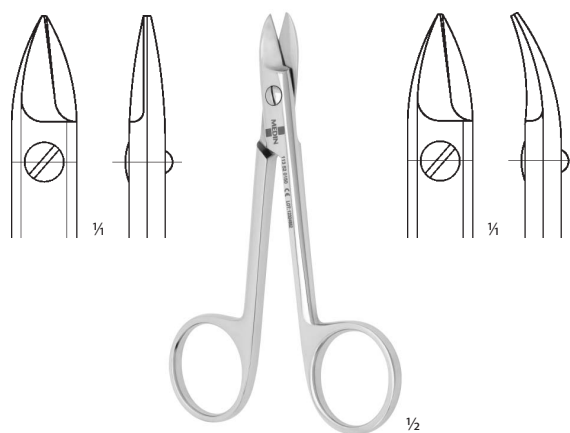

**114 52 0060**  
jemná  
fine  
11,0 cm  
0,4 mm

NŮŽKY NA KORUNKY  
CROWN SCISSORS

**113 52 0150**  
rovné  
straight

11,0 cm

**113 52 0160**  
zahnuté  
curved

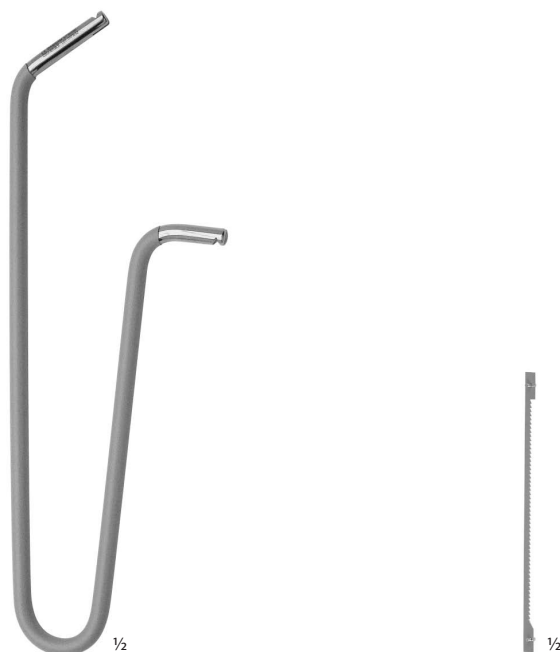
PILKY STOMATOLOGICKÉ  
STOMATOLOGICAL SAWS

Upínací rám pilky stomatologické  
Frame of stomatological saw  
**127 50 0150**  
190 x 65 cm

List k pilce stomatologické  
Blade of stomatological saw  
**127 50 0001**  
7,3 cm



Nůž na sádku  
Plaster knife  
**121 52 0050**  
18,0 cm



Lopatka na sádku  
Plaster spatula  
**121 52 0060**  
16,8 cm  
40/30 mm



Lopatka na míchání  
Mixing spatula  
**121 52 0080**  
21,0 cm  
27 mm

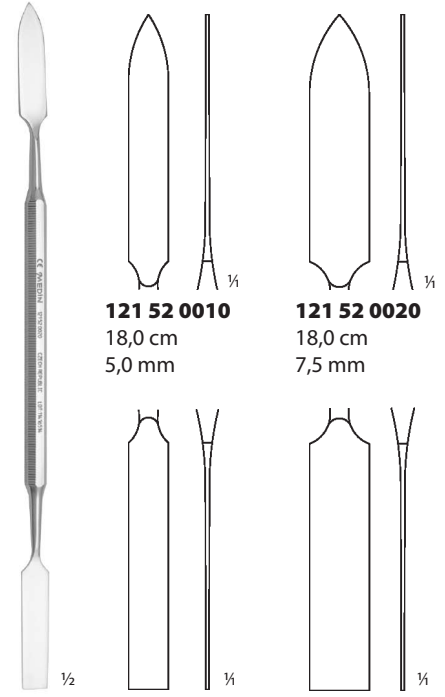

**121 52 0010**  
18,0 cm  
5,0 mm

**121 52 0020**  
18,0 cm  
7,5 mm

Lopatka na cement  
Cement spatula  
**121 52 0020**  
18,0 cm

LŽIČKY LABORATORNÍ  
LABORATORY SPOONS



**125 53 0010**  
15,0 cm



**125 53 0020**  
20,0 cm

SOUBOR PRO ZUBNÍ TECHNIKY  
SET FOR DENTAL TECHNICIANS

1/2

**139 50 0360**soubor  
set**114 50 0011** Pinzeta zubní**115 08 0020** Mosquito-Halsted svorka, zahnutá**117 52 0700** Kleště laboratorní; Fig. 1**121 52 0050** Nůž na sádku**155 52 0180** Le Cron modelovací nástroj**155 52 0212** Nůž modelovací**155 52 0222** Nůž modelovací

Dental forceps

Mosquito-Halsted forceps, bent

Laboratory forceps; Fig. 1

Plaster knife

Le Cron modelling instrument

Modelling knife

Modelling knife

ks / pcs

1

1

1

1

1

1

1

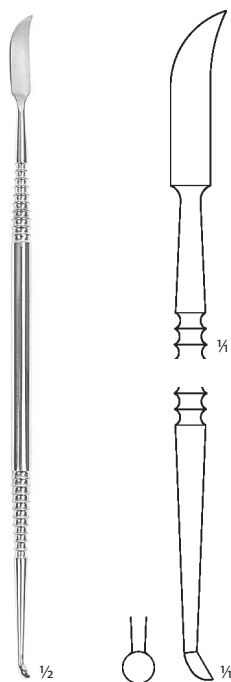

**LE CRON**  
**155 52 0180**  
17,5 cm



**155 52 0212**  
13,0 cm



**155 52 0222**  
17,4 cm

NÁSTROJE MODELOVACÍ – PLASTOVÉ DRŽÁTKO  
MODELLING INSTRUMENTS – PLASTIC HANDLE

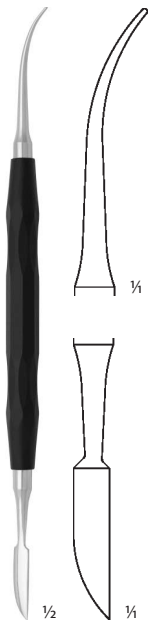

**155 52 1402**  
16,2 cm  
Fig. 1

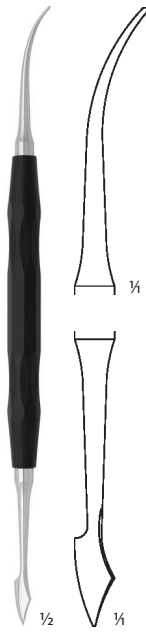

**155 52 1412**  
16,4 cm  
Fig. 2

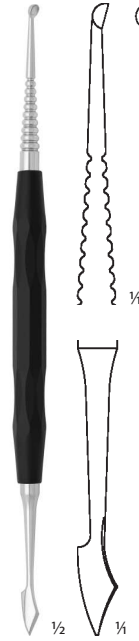

**155 52 1422**  
16,7 cm  
Fig. 3

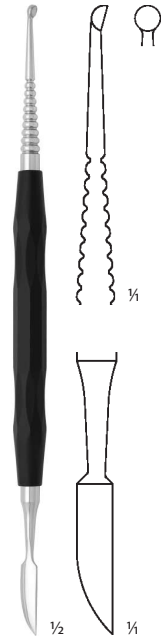

**155 52 1432**  
16,5 cm  
Fig. 4

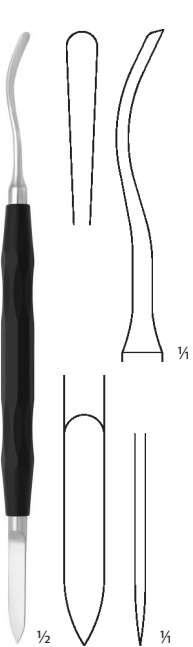

**155 52 1442**  
16,2 cm  
Fig. 5

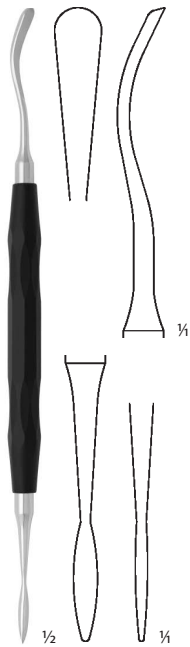

**155 52 1452**  
16,8 cm  
Fig. 6

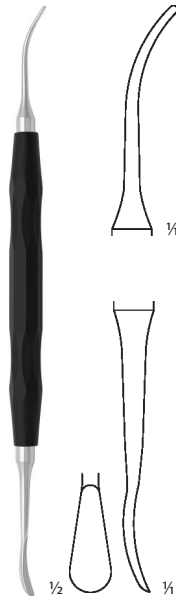

**155 52 1462**  
15,6 cm  
Fig. 7

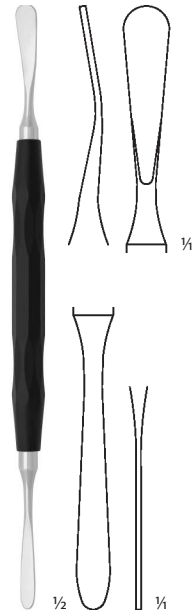

**155 52 1472**  
15,9 cm  
Fig. 8

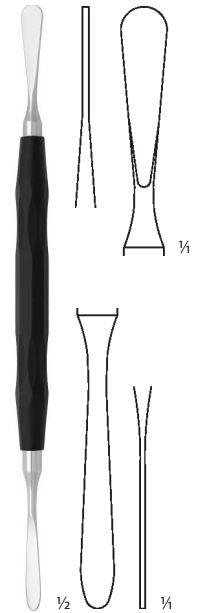

**155 52 1482**  
15,9 cm  
Fig. 9





**155 52 9000**

soubor  
set  
20,0 × 12,0 × 2,8 cm

<b>112 91 0004</b>	Držák skalpelových čepelek, vel. 4
<b>114 08 0101</b>	Pinzeta anatomická, rovná, jemná
<b>115 08 0010</b>	Mosquito-Halstead svorka, rovná
<b>155 52 1402</b>	Modelovací nástroj, Fig. 1
<b>155 52 1412</b>	Modelovací nástroj, Fig. 2
<b>155 52 1422</b>	Modelovací nástroj, Fig. 3
<b>155 52 1432</b>	Modelovací nástroj, Fig. 4
<b>155 52 1442</b>	Modelovací nástroj, Fig. 5
<b>155 52 1452</b>	Modelovací nástroj, Fig. 6
<b>155 52 1462</b>	Modelovací nástroj, Fig. 7
<b>155 52 1472</b>	Modelovací nástroj, Fig. 8
<b>155 52 1482</b>	Modelovací nástroj, Fig. 9

Scalpel handle, No. 4	ks / pcs	1
Dressing forceps, straight, fine		1
Mosquito-Halstead forceps, straight		1
Modelling instrument, Fig. 1		1
Modelling instrument, Fig. 2		1
Modelling instrument, Fig. 3		1
Modelling instrument, Fig. 4		1
Modelling instrument, Fig. 5		1
Modelling instrument, Fig. 6		1
Modelling instrument, Fig. 7		1
Modelling instrument, Fig. 8		1
Modelling instrument, Fig. 9		1



Kladívko laboratorní  
Laboratory mallet  
**128 52 0110**  
vypouklé, leštěné  
convex, polished  
26,0 cm



Kladívko laboratorní  
Laboratory mallet  
**128 52 0111**  
rovné, matované  
straight, mat  
26,0 cm

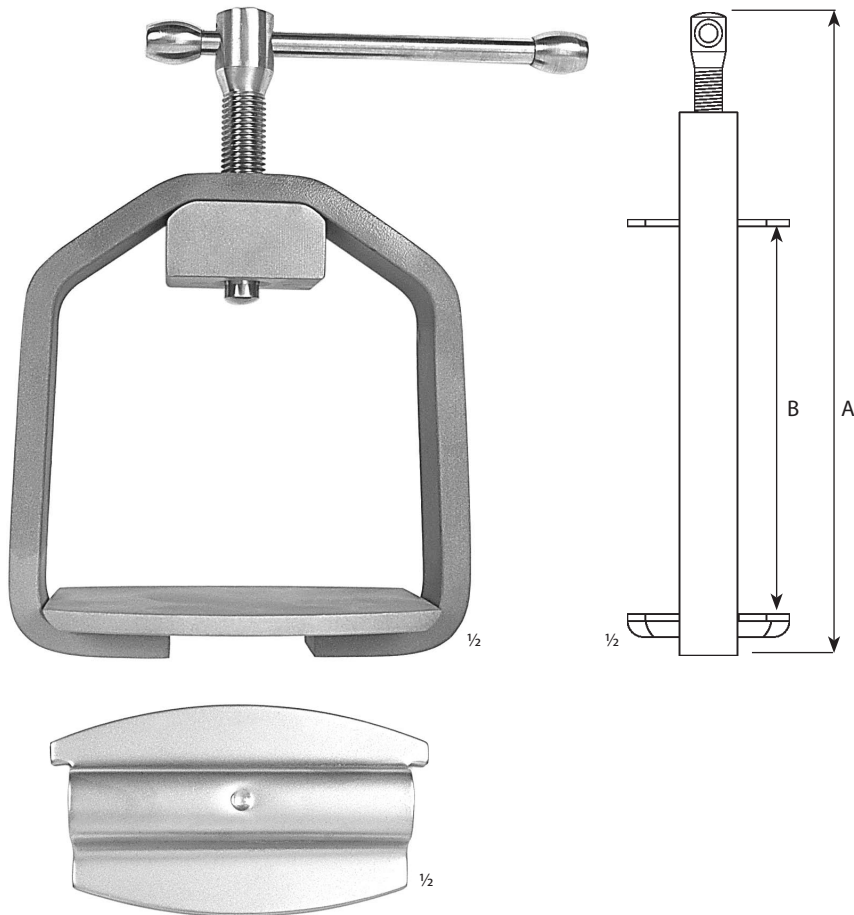

**157 52 0030** Třmen pro jednu kyvetu

**157 52 0040** Třmen pro dvě kyvety

**157 52 0050** Třmen pro tři kyvety

Clap for one flask

Clap for two flasks

Clap for three flasks

A  
17,0 cm

22,5 cm

28,0 cm

B  
6,4 cm

12,0 cm

17,5 cm



Kyveta čtyřdílná  
Four piece flask  
**157 52 0021**  
nerez  
stainless steel  
12,6 × 9,3 × 5,3 cm



Kyveta čtyřdílná  
Four piece flask  
**157 52 0031**  
mosaz  
brass  
10,0 × 8,6 × 5,6 cm



Kyveta korunková  
Crown flask  
**157 52 0011**  
nerez  
stainless steel  
5,0 cm  
Ø 5,5 cm



Opěrka kyvety korunkové  
Support of crown flask  
**157 52 0210**  
3,0 cm  
Ø 6,0 cm

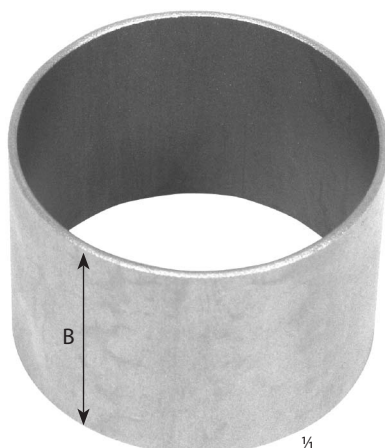

**158 99 0023**

nerez  
stainless steel  
5,5 cm

	Ø	B
<b>158 99 0025</b>	3,0 cm	5,5 cm
<b>158 99 0022</b>	3,8 cm	5,5 cm
<b>158 99 0023</b>	4,8 cm	5,5 cm
<b>158 99 0024</b>	6,5 cm	5,5 cm
<b>158 99 0026</b>	8,0 cm	5,5 cm

PODLOŽKA POD LICÍ KROUŽKY  
WASHER FOR CASTING RINGS



**158 91 0001**

guma  
rubber  
Ø 9,0 cm

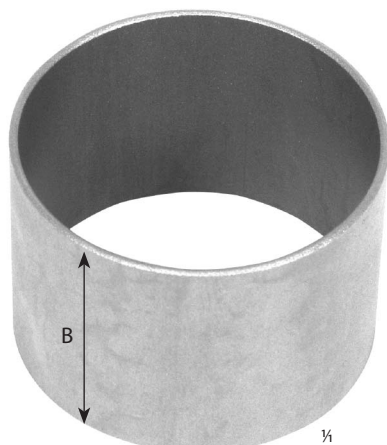
KROUŽKY KOVOVÉ LICÍ  
CASTING RINGS

**158 52 0050**  
nerez  
stainless steel  
5,5 cm

	Ø	B
<b>158 52 0010</b>	2,2 cm	3,0 cm
<b>158 52 0020</b>	2,8 cm	4,0 cm
<b>158 52 0030</b>	4,0 cm	4,5 cm
<b>158 52 0040</b>	4,0 cm	4,8 cm
<b>158 52 0050</b>	5,0 cm	5,5 cm
<b>158 52 0060</b>	6,0 cm	5,5 cm
<b>158 52 0070</b>	7,0 cm	5,5 cm
<b>158 52 0080</b>	8,0 cm	5,5 cm
<b>158 52 0090</b>	2,5 cm	3,5 cm

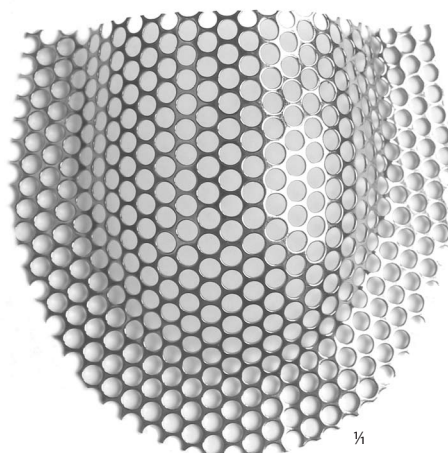
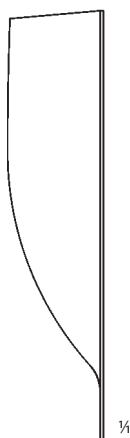
ZESILOVACÍ MŘÍŽKY  
MESH STRENGTHENERS

**152 52 1900**  
zlačená  
gold plated  
60 × 54 × 12 mm

**152 52 1910**  
nerezová  
stainless  
60 × 54 × 12 mm

**OTISKOVACÍ LŽÍCE PRO HORNÍ OZUBENOU ČELIST**  
**IMPRESSION TRAYS FOR TOOTHED UPPER JAWS**

s retenčním okrajem  
with retentive edge

**154 52 9010** H1  
**154 52 9011** H2  
**154 52 9012** H3  
**154 52 9013** H4



s retenčním okrajem, perforované  
with retentive edge, perforated

**154 52 9018** HX1  
**154 52 9019** HX2  
**154 52 9020** HX3  
**154 52 9021** HX4



perforované  
perforated

**154 52 0110** BOX1  
**154 52 0120** BOX2  
**154 52 0130** BOX3  
**154 52 0140** BOX4

**OTISKOVACÍ LŽÍCE PRO DOLNÍ OZUBENOU ČELIST**  
**IMPRESSION TRAYS FOR TOOTHED LOWER JAWS**

s retenčním okrajem  
with retentive edge

**154 52 9014** D1  
**154 52 9015** D2  
**154 52 9016** D3  
**154 52 9017** D4



s retenčním okrajem, perforované  
with retentive edge, perforated

**154 52 9022** DX1  
**154 52 9023** DX2  
**154 52 9024** DX3  
**154 52 9025** DX4



perforované  
perforated

**154 52 0260** FX1  
**154 52 0270** FX2  
**154 52 0280** FX3  
**154 52 0290** FX4

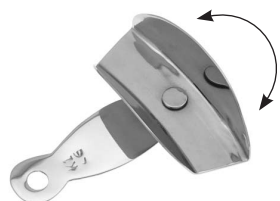
**OTISKOVACÍ LŽÍCE**  
**IMPRESSION TRAYS**

**154 52 0600**  
korunková  
crown



**154 52 0560**  
poloviční levá perforovaná  
for partial impressions left perforated  
PLX



**154 52 0550**  
poloviční pravá perforovaná  
for partial impressions right perforated  
PPX

Otiskovací lžice  
Impression trays

**154 52 1550**  
soubor  
set

<b>154 52 0110</b>	BOX1	1x
<b>154 52 0120</b>	BOX2	1x
<b>154 52 0130</b>	BOX3	1x
<b>154 52 0140</b>	BOX4	1x
<b>154 52 0260</b>	FX1	1x
<b>154 52 0270</b>	FX2	1x
<b>154 52 0280</b>	FX3	1x
<b>154 52 0550</b>	PPX	1x
<b>154 52 0560</b>	PLX	1x

OTISKOVAČÍ LŽÍCE – DĚTSKÉ  
IMPRESSION TRAYS – CHILDREN

pro horní čelist, perforovaná  
for upper jaws, perforated

**154 52 0360** DHX1  
**154 52 0370** DHX2  
**154 52 0380** DHX3



pro dolní čelist, perforovaná  
for lower jaws, perforated

**154 52 0460** DDX1  
**154 52 0470** DDX2  
**154 52 0480** DDX3

Otiskovací lžice dětské  
Impression trays for children  
**154 52 1650**  
soubor  
set

<b>154 52 0360</b>	DHX1	1x
<b>154 52 0370</b>	DHX2	1x
<b>154 52 0380</b>	DHX3	1x
<b>154 52 0460</b>	DDX1	1x
<b>154 52 0470</b>	DDX2	1x
<b>154 52 0480</b>	DDX3	1x

OTISKOVAČÍ LŽÍCE PRO BEZZUBOU ČELIST  
IMPRESSION TRAYS FOR TOOTHLESS JAWS

horní, perforovaná  
upper, perforated

**154 52 0610** FOX1  
**154 52 0620** FOX2  
**154 52 0630** FOX3  
**154 52 0640** FOX4



dolní, perforovaná  
lower, perforated

**154 52 0660** UUX1  
**154 52 0670** UUX2  
**154 52 0680** UUX3  
**154 52 0690** UUX4

OTISKOVAČÍ LŽÍCE PRO ČÁSTEČNĚ OZUBENOU ČELIST  
IMPRESSION TRAYS FOR PARTIALLY TOOTHED JAWS

**154 52 0790**  
horní, perforovaná  
upper, perforated  
BOXC3



**154 52 0820**  
dolní, perforovaná  
lower, perforated  
FXC2



**154 52 0830**  
dolní, perforovaná  
lower, perforated  
FXC3





**STERILIZACE A POMOCNÉ VYBAVENÍ**  
**STERILIZATION AND ACCESSORIES**



<b>Nádobky</b>	Boxes	137
<b>Držátka ubrousku</b>	Napkin Holders	137
<b>Toulce</b>	Quivers	138
<b>Kazety, nádobky</b>	Cassettes, Bowls	139
<b>Krabičky</b>	Boxes	139–141
<b>Tácky</b>	Trays	141
<b>Bubny sterilizační</b>	Sterilization Drums	142–143
<b>Sterilizační kontejnery</b>	Containers for Sterilization	144–148



Nádobka na vatu s pružinou  
Cotton wool box with spring  
**159 53 0050**  
7,5 cm  
Ø 5,0 cm



Nádobka na vatové odpady  
Cotton wool bin  
**159 53 0060**  
6,5 cm  
Ø 5,0 cm

DRŽÁTKA UBROUSKU  
NAPKIN HOLDERS



Držátko ubrousku řetízkové  
Napkin holder with metal chain  
**159 53 0100**  
47,0 cm  
umělohmotné svorky  
plastic clip



Držátko ubrousku uh  
Napkin holder  
**159 53 0110**  
48,0 cm  
kovové svorky Aligátor  
metal clips Aligator



Držátko ubrousku řetízkové  
Napkin holder with metal chain  
**159 53 0120**  
23,0 cm  
kovové svorky Aligátor  
metal clips Aligator



**136 39 0010**  
4,7×9,0 cm  
na pinzety, leštěný  
for tweezers, polished



**136 39 0020**  
6,6×20,0 cm  
na podávkové kleště, leštěný  
for forceps, polished



**136 39 0030**  
4,3×9,0 cm  
na pinzety, matovaný  
for tweezers, mat



**136 39 0040**  
7,0×20,0 cm  
na podávkové kleště, matovaný  
for forceps, mat

## TOULCE S PODSTAVCEM QUIVERS WITH STAND



**136 39 0050**  
70×110 mm  
na pinzety  
for tweezers



**136 39 0060**  
70×200 mm  
na kleště  
for forceps



**136 39 0070**  
50×90 mm  
na pinzety  
for tweezers

**KAZETA S DRŽÁKEM**  
CASSETTE WITH HOLDER



Držák  
Holder  
**139 50 0150**  
aluminium  
21,0 × 9,6 × 1,6 cm



Kazeta s držákem  
Cassette with holder  
**139 50 0160**  
aluminium  
22,0 × 10,5 × 3,6 cm



Kazeta  
Cassette  
**139 50 0170**  
aluminium  
22,0 × 10,5 × 3,6 cm

**NÁDOBKY**  
BOWLS



**136 39 0260**  
nerez – stainless steel  
175×100×25 mm



**136 39 0270**  
nerez – stainless steel  
90×40 mm



**136 39 0320**  
nerez – stainless steel  
82×30 mm

**KRABÍČKY KULATÉ**  
BOXES ROUND



**136 39 0213** 40 × 13 mm  
**136 39 0211** 65 × 15 mm  
**136 39 0214** 80 × 18 mm  
**136 39 0215** 90 × 20 mm  
**136 39 0216** 100 × 20 mm  
nerez – stainless steel



Krabička perforovaná  
Box round  
**136 39 0212**  
nerez – stainless steel  
62×13 mm

KRABÍČKY PRO HORKOVZDUŠNOU STERILIZACI  
BOXES FOR DRY-HEAT STERILIZATION

**136 39 0140**  
nerez – stainless steel  
200×100×30 mm



**136 39 0150**  
nerez – stainless steel  
170×70×30 mm



**136 39 0160**  
nerez – stainless steel  
200×100×40 mm



**136 39 0170**  
nerez – stainless steel  
210×115×45 mm



**136 39 0180**  
nerez – stainless steel  
dvojití víčko – double lid  
210×110×25 mm



**136 39 0190**  
nerez – stainless steel  
210×115×45 mm



**136 39 0200**  
nerez – stainless steel  
na katetry – for catheters  
300×80×40 mm



**136 39 0220**  
nerez – stainless steel  
350×90×50 mm



**136 39 0230**  
nerez – stainless steel  
230×150×60 mm



**136 39 0240**  
nerez – stainless steel  
300×200×50 mm



**136 39 0250**  
nerez – stainless steel  
200×150×45 mm



**136 39 0110**  
nerez – stainless steel  
180×120×15 mm

TÁCKY  
TRAYS



**136 39 0330**  
nerez – stainless steel  
200×100×10 mm



**136 39 0340**  
nerez – stainless steel  
190×100×10 mm



**136 39 0350**  
nerez – stainless steel  
200×100×30 mm



**136 39 0360**  
nerez – stainless steel  
190×100×10 mm



**136 39 0370**  
nerez – stainless steel  
280×190×20 mm



**136 39 0380**  
nerez – stainless steel  
350×250×20 mm

KRABÍČKY  
BOXES



**136 39 0210**  
nerez – stainless steel  
92×40×17 mm



**136 39 0410**  
plast – plastic  
na umělý chrup – for denture  
80×80×40 mm

BUBNY STERILIZAČNÍ PRO HORKOVZDUŠNOU STERILIZACI  
STERILIZATION DRUMS FOR DRY-HEAT STERILIZATIONBuben sterilizační  
Sterilization drum

<b>136 91 1314</b>	125×80 mm	<b>136 91 1342</b>	290×190 mm
<b>136 91 1315</b>	125×100 mm	<b>136 91 1343</b>	290×240 mm
<b>136 91 1316</b>	125×125 mm	<b>136 91 1344</b>	290×290 mm
<b>136 91 1317</b>	150×80 mm	<b>136 91 1345</b>	290×340 mm
<b>136 91 1318</b>	150×100 mm	<b>136 91 1346</b>	290×390 mm
<b>136 91 1319</b>	150×130 mm	<b>136 91 1347</b>	340×120 mm
<b>136 91 1320</b>	150×150 mm	<b>136 91 1348</b>	340×145 mm
<b>136 91 1321</b>	150×190 mm	<b>136 91 1349</b>	340×165 mm
<b>136 91 1322</b>	150×240 mm	<b>136 91 1350</b>	340×190 mm
<b>136 91 1323</b>	190×95 mm	<b>136 91 1351</b>	340×240 mm
<b>136 91 1324</b>	190×125 mm	<b>136 91 1352</b>	340×290 mm
<b>136 91 1325</b>	190×145 mm	<b>136 91 1353</b>	340×340 mm
<b>136 91 1326</b>	190×165 mm	<b>136 91 1354</b>	340×390 mm
<b>136 91 1327</b>	190×190 mm	<b>136 91 1355</b>	390×140 mm
<b>136 91 1328</b>	190×240 mm	<b>136 91 1356</b>	390×165 mm
<b>136 91 1329</b>	190×290 mm	<b>136 91 1357</b>	390×190 mm
<b>136 91 1330</b>	240×95 mm	<b>136 91 1358</b>	390×240 mm
<b>136 91 1331</b>	240×120 mm	<b>136 91 1359</b>	390×290 mm
<b>136 91 1332</b>	240×145 mm	<b>136 91 1360</b>	390×340 mm
<b>136 91 1333</b>	240×165 mm	<b>136 91 1361</b>	390×390 mm
<b>136 91 1334</b>	240×190 mm	<b>136 91 1362</b>	390×490 mm
<b>136 91 1335</b>	240×240 mm	<b>136 91 1363</b>	390×590 mm
<b>136 91 1336</b>	240×290 mm	<b>136 91 1364</b>	480×165 mm
<b>136 91 1337</b>	240×340 mm	<b>136 91 1365</b>	480×190 mm
<b>136 91 1338</b>	240×390 mm	<b>136 91 1366</b>	480×240 mm
<b>136 91 1339</b>	290×120 mm	<b>136 91 1367</b>	480×290 mm
<b>136 91 1340</b>	290×145 mm	<b>136 91 1368</b>	480×340 mm
<b>136 91 1341</b>	290×165 mm	<b>136 91 1369</b>	480×390 mm



**BUBNY STERILIZAČNÍ PRO PARNÍ STERILIZACI**  
STERILIZATION DRUMS FOR STEAM STERILIZATION



Buben sterilizační  
Sterilization drum

<b>136 91 1275</b>	125×80 mm	<b>136 91 1295</b>	290×120 mm
<b>136 91 1276</b>	125×100 mm	<b>136 91 1296</b>	290×145 mm
<b>136 91 1277</b>	125×125 mm	<b>136 91 1297</b>	290×165 mm
<b>136 91 1278</b>	150×100 mm	<b>136 91 1298</b>	290×190 mm
<b>136 91 1279</b>	150×130 mm	<b>136 91 1299</b>	290×240 mm
<b>136 91 1280</b>	150×150 mm	<b>136 91 1300</b>	290×290 mm
<b>136 91 1281</b>	150×190 mm	<b>136 91 1301</b>	340×120 mm
<b>136 91 1282</b>	150×240 mm	<b>136 91 1302</b>	340×145 mm
<b>136 91 1283</b>	190×95 mm	<b>136 91 1303</b>	340×165 mm
<b>136 91 1284</b>	190×125 mm	<b>136 91 1304</b>	340×190 mm
<b>136 91 1285</b>	190×145 mm	<b>136 91 1305</b>	340×240 mm
<b>136 91 1286</b>	190×165 mm	<b>136 91 1306</b>	340×290 mm
<b>136 91 1287</b>	190×190 mm	<b>136 91 1307</b>	390×140 mm
<b>136 91 1288</b>	190×240 mm	<b>136 91 1308</b>	390×165 mm
<b>136 91 1289</b>	190×290 mm	<b>136 91 1309</b>	390×190 mm
<b>136 91 1290</b>	240×120 mm	<b>136 91 1310</b>	390×240 mm
<b>136 91 1291</b>	240×165 mm	<b>136 91 1311</b>	390×290 mm
<b>136 91 1292</b>	240×190 mm	<b>136 91 1312</b>	390×340 mm
<b>136 91 1293</b>	240×240 mm	<b>136 91 1313</b>	390×390 mm
<b>136 91 1294</b>	240×290 mm		

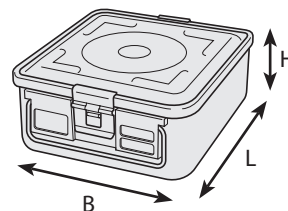
KONTEJNERY, VELIKOST 1/2  
CONTAINERS, SIZE 1/2

## Kontejnery – Containers

barevná pouze víka  
lid colored only

L	B	H						
285 × 280 × 100 mm			<b>136 91 0259</b>	<b>136 91 0260</b>	<b>136 91 0261</b>	<b>136 91 0262</b>	<b>136 91 0263</b>	<b>136 91 0264</b>
285 × 280 × 135 mm			<b>136 91 0265</b>	<b>136 91 0266</b>	<b>136 91 0267</b>	<b>136 91 0268</b>	<b>136 91 0269</b>	<b>136 91 0270</b>
285 × 280 × 150 mm			<b>136 91 0271</b>	<b>136 91 0272</b>	<b>136 91 0273</b>	<b>136 91 0274</b>	<b>136 91 0275</b>	<b>136 91 0276</b>
285 × 280 × 200 mm			<b>136 91 0277</b>	<b>136 91 0278</b>	<b>136 91 0279</b>	<b>136 91 0280</b>	<b>136 91 0281</b>	<b>136 91 0282</b>
285 × 280 × 260 mm			<b>136 91 0283</b>	<b>136 91 0284</b>	<b>136 91 0285</b>	<b>136 91 0286</b>	<b>136 91 0287</b>	<b>136 91 0288</b>

barevná pouze víka  
lid colored only

285 × 280 × 110 mm			<b>136 91 0337</b>	<b>136 91 0338</b>	<b>136 91 0339</b>	<b>136 91 0340</b>	<b>136 91 0341</b>	<b>136 91 0342</b>
285 × 280 × 135 mm			<b>136 91 0343</b>	<b>136 91 0344</b>	<b>136 91 0345</b>	<b>136 91 0346</b>	<b>136 91 0347</b>	<b>136 91 0348</b>
285 × 280 × 150 mm			<b>136 91 0349</b>	<b>136 91 0350</b>	<b>136 91 0351</b>	<b>136 91 0352</b>	<b>136 91 0353</b>	<b>136 91 0354</b>
285 × 280 × 200 mm			<b>136 91 0355</b>	<b>136 91 0356</b>	<b>136 91 0357</b>	<b>136 91 0358</b>	<b>136 91 0359</b>	<b>136 91 0360</b>
285 × 280 × 260 mm			<b>136 91 0361</b>	<b>136 91 0362</b>	<b>136 91 0363</b>	<b>136 91 0364</b>	<b>136 91 0365</b>	<b>136 91 0366</b>

## Víka – Lids



L	B							
285 × 280 mm			<b>136 91 0415</b>	<b>136 91 0416</b>	<b>136 91 0417</b>	<b>136 91 0418</b>	<b>136 91 0419</b>	<b>136 91 0420</b>
285 × 280 mm			<b>136 91 0438</b>	<b>136 91 0439</b>	<b>136 91 0440</b>	<b>136 91 0441</b>	<b>136 91 0442</b>	<b>136 91 0443</b>
285 × 280 mm			<b>136 91 0490</b>	<b>136 91 0491</b>	<b>136 91 0492</b>	<b>136 91 0493</b>	<b>136 91 0494</b>	<b>136 91 0495</b>

## Vany – Bottoms

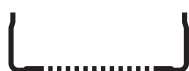
barevná pouze víka  
lid colored only

285 × 280 × 100 mm			<b>136 91 0463</b>
285 × 280 × 135 mm			<b>136 91 0464</b>
285 × 280 × 150 mm			<b>136 91 0465</b>
285 × 280 × 200 mm			<b>136 91 0466</b>
285 × 280 × 260 mm			<b>136 91 0467</b>

barevná pouze víka  
lid colored only

285 × 280 × 100 mm			<b>136 91 0475</b>
285 × 280 × 135 mm			<b>136 91 0476</b>
285 × 280 × 150 mm			<b>136 91 0477</b>
285 × 280 × 200 mm			<b>136 91 0478</b>
285 × 280 × 260 mm			<b>136 91 0479</b>

## Koše – Basket



L	B	H	
255 × 245 × 30 mm			<b>136 91 0526</b>
255 × 245 × 50 mm			<b>136 91 0527</b>
255 × 245 × 70 mm			<b>136 91 0528</b>
255 × 245 × 100 mm			<b>136 91 0529</b>

## Síto – Divider



L	B	H	
255 × 245 × 130 mm			<b>136 91 0675</b>

## Rámy – Retainers



L	B	H	
255 × 255 mm			<b>136 91 0667</b>
255 × 255 × 30 mm			<b>136 91 0668</b>

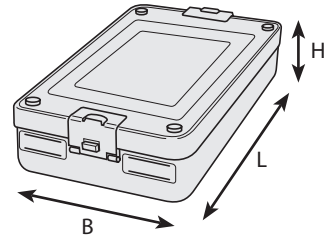

Kontejnery – Containers



barevná pouze víka  
lid colored only

L	B	H						
310 × 190 × 40 mm			<b>136 91 0696</b>	<b>136 91 0697</b>	<b>136 91 0698</b>	<b>136 91 0699</b>	<b>136 91 0700</b>	<b>136 91 0701</b>
310 × 190 × 65 mm			<b>136 91 0702</b>	<b>136 91 0703</b>	<b>136 91 0704</b>	<b>136 91 0705</b>	<b>136 91 0706</b>	<b>136 91 0707</b>
310 × 190 × 130 mm			<b>136 91 0708</b>	<b>136 91 0709</b>	<b>136 91 0710</b>	<b>136 91 0711</b>	<b>136 91 0712</b>	<b>136 91 0713</b>



barevná pouze víka  
lid colored only

310 × 190 × 40 mm			<b>136 91 0714</b>	<b>136 91 0715</b>	<b>136 91 0716</b>	<b>136 91 0717</b>	<b>136 91 0718</b>	<b>136 91 0719</b>
310 × 190 × 65 mm			<b>136 91 0720</b>	<b>136 91 0721</b>	<b>136 91 0722</b>	<b>136 91 0723</b>	<b>136 91 0724</b>	<b>136 91 0725</b>
310 × 190 × 130 mm			<b>136 91 0726</b>	<b>136 91 0727</b>	<b>136 91 0728</b>	<b>136 91 0729</b>	<b>136 91 0730</b>	<b>136 91 0731</b>

Víka – Lids



L	B							
310 × 190 mm			<b>136 91 0645</b>	<b>136 91 0646</b>	<b>136 91 0647</b>	<b>136 91 0648</b>	<b>136 91 0649</b>	<b>136 91 0650</b>
310 × 190 mm			<b>136 91 0653</b>	<b>136 91 0654</b>	<b>136 91 0655</b>	<b>136 91 0656</b>	<b>136 91 0657</b>	<b>136 91 0658</b>

Vany – Bottoms



barevná pouze víka  
lid colored only

L	B	H	
310 × 190 × 40 mm			<b>136 91 0690</b>
310 × 190 × 65 mm			<b>136 91 0691</b>
310 × 190 × 130 mm			<b>136 91 0692</b>

Koš – Basket



L	B	H	
274 × 172 × 43 mm			<b>136 91 0662</b>

Rám – Retainer



L	B	
310 × 190 × 40 mm		<b>136 91 0693</b>
310 × 190 × 65 mm		<b>136 91 0694</b>
310 × 190 × 130 mm		<b>136 91 0695</b>
270 × 170 mm		<b>136 91 0669</b>

barevná pouze víka  
lid colored only

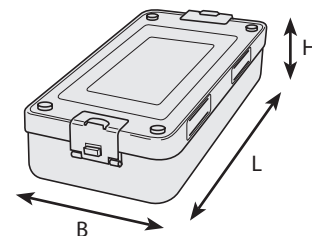
KONTEJNERY MINI  
SMALL CONTAINERS

## Kontejnery – Containers

barevná pouze víka  
lid colored only

L	B	H						
300 × 140 × 40 mm			<b>136 91 0569</b>	<b>136 91 0570</b>	<b>136 91 0571</b>	<b>136 91 0572</b>	<b>136 91 0573</b>	<b>136 91 0684</b>
300 × 140 × 70 mm			<b>136 91 0574</b>	<b>136 91 0575</b>	<b>136 91 0576</b>	<b>136 91 0577</b>	<b>136 91 0578</b>	<b>136 91 0685</b>
300 × 140 × 100 mm			<b>136 91 0579</b>	<b>136 91 0580</b>	<b>136 91 0581</b>	<b>136 91 0582</b>	<b>136 91 0583</b>	<b>136 91 0686</b>

barevná pouze víka  
lid colored only

300 × 140 × 40 mm			<b>136 91 0584</b>	<b>136 91 0585</b>	<b>136 91 0586</b>	<b>136 91 0587</b>	<b>136 91 0588</b>	<b>136 91 0687</b>
300 × 140 × 70 mm			<b>136 91 0589</b>	<b>136 91 0590</b>	<b>136 91 0591</b>	<b>136 91 0592</b>	<b>136 91 0593</b>	<b>136 91 0688</b>
300 × 140 × 100 mm			<b>136 91 0594</b>	<b>136 91 0595</b>	<b>136 91 0596</b>	<b>136 91 0597</b>	<b>136 91 0598</b>	<b>136 91 0689</b>

## Víka – Lids



L	B							
300 × 140 mm			<b>136 91 0485</b>	<b>136 91 0486</b>	<b>136 91 0487</b>	<b>136 91 0488</b>	<b>136 91 0489</b>	<b>136 91 0652</b>
300 × 140 mm			<b>136 91 0513</b>	<b>136 91 0514</b>	<b>136 91 0515</b>	<b>136 91 0516</b>	<b>136 91 0517</b>	<b>136 91 0659</b>

## Vany – Bottoms

barevná pouze víka  
lid colored only

L	B	H	
300 × 140 × 40 mm			<b>136 91 0599</b>
300 × 140 × 70 mm			<b>136 91 0600</b>
300 × 140 × 100 mm			<b>136 91 0601</b>

barevná pouze víka  
lid colored only

300 × 140 × 40 mm			<b>136 91 0602</b>
300 × 140 × 70 mm			<b>136 91 0603</b>
300 × 140 × 100 mm			<b>136 91 0604</b>

## Koš – Basket



L	B	H	
267 × 125 × 50 mm			<b>136 91 0661</b>

## Síto – Divider



L	B	
270 × 125 mm		<b>136 91 0660</b>

## Rám – Retainer



L	B	
270 × 155 mm		<b>136 91 0670</b>

**PŘÍSLUŠENSTVÍ PRO STERILIZAČNÍ KONTEJNERY**  
 ACCESSORIES FOR CONTAINERS FOR STERILIZATION

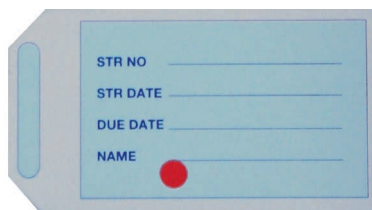
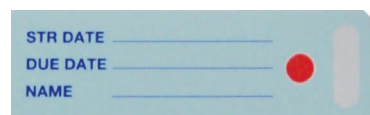
**ŠTÍTKY IDENTIFIKAČNÍ PAPIROVÉ**  
 PAPER LABELS WITH INDICATOR

**136 91 0540**  
 standard – standard  
 100 ks/pcs

**136 91 0541**  
 malý – small  
 100 ks/pcs

**ŠTÍTKY IDENTIFIKAČNÍ**  
 IDENTIFICATION LABELS

**136 91 0543**   **136 91 0544**   **136 91 0545**   **136 91 0546**   **136 91 0547**   **136 91 0548**
**ŠTÍTKY IDENTIFIKAČNÍ HLINÍKOVÉ PRO TEXT**  
 IDENTIFICATION ALUMINIUM LABELS ENGRAVE

**136 91 0550**   **136 91 0551**   **136 91 0552**   **136 91 0553**   **136 91 0554**   **136 91 0555**
**ZÁMEK BEZPEČNOSTNÍ PLASTOVÝ, PLOMBA PRO STERILIZAČNÍ KONTEJNERY**  
 PLASTIC SECURITY SEAL, SEAL FOR STERILIZING CONTAINERS

**136 91 0542**  
 100 ks/pcs

**285 499 54 7000**  
 100 ks/pcs

**FILTRY**  
 FILTERS

	typ – model	materiál – material	balení – packing
	<b>136 91 0534</b> standard – standard	papír – paper	100 ks/pcs
	<b>136 91 0535</b> standard – standard	textil – textile	1 ks/pcs
	<b>136 91 0635</b> standard – standard	teflon – teflon	1 ks/pcs
	<b>136 91 0536</b> mini – small	papír – paper	100 ks/pcs
	<b>136 91 0537</b> mini – small	textil – textile	1 ks/pcs
	<b>136 91 0676</b> dentální – dental	papír – paper	100 ks/pcs
	<b>136 91 0677</b> dentální – dental	textil – textile	1 ks/pcs

**PŘÍSLUŠENSTVÍ PRO STERILIZAČNÍ KONTEJNERY**  
 ACCESSORIES FOR CONTAINERS FOR STERILIZATION

**ROUŠKY, PODLOŽKY**  
 CLOTHS, MATS

 Roušky textilní, zelené  
 Green cloths

60 × 40 cm	<b>136 91 0619</b>
85 × 85 cm	<b>136 91 0620</b>
100 × 140 cm	<b>136 91 0621</b>
275 × 125 cm	<b>136 91 0622</b>
245 × 245 cm	<b>136 91 0623</b>

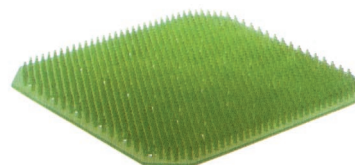
 Podložky silikonové  
 Silicon mats

275 × 125 mm	<b>136 91 0624</b>
225 × 225 mm	<b>136 91 0625</b>
300 × 300 mm	<b>136 91 0626</b>
440 × 230 mm	<b>136 91 0630</b>
500 × 210 mm	<b>136 91 0389</b>

**STERILIZAČNÍ KONTEJNERY A PŘÍSLUŠENSTVÍ**  
 CONTAINERS FOR STERILIZATION AND ACCESSORIES

Kompletní nabídku sterilizačních kontejnerů a příslušenství naleznete v katalogu STERILIZAČNÍ KONTEJNERY.

All of the range of containers for sterilization and accessories can be found in catalogue of CONTAINERS FOR STERILIZATION.

[www.medin.cz](http://www.medin.cz)

Katalog je dostupný na internetových stránkách MEDIN, a.s.  
 Tištěnou verzi katalogu si můžete vyžádat u našich obchodních zástupců.

The catalogue is available for download on our MEDIN, a.s., web sites.  
 Printed version is on request at our Sales Representatives.

číslo – number	název	item	strana – page
<b>112</b>	<b>Nástroje řezné</b>	<b>Cutting Instruments</b>	
<b>112 08 0696</b>	Držátko skalpelových čepelek – kov; 15,0 cm	Scalpel handle; 15,0 cm	42
<b>112 08 0700</b>	Utahovací klíček; 8,0 cm	Spanner; 8,0 cm	42
<b>112 38 0010</b>	Dieffenbach skalpel oční bříškatý; 1,7 cm, fig. 1	Dieffenbach knife; 1,7 cm, fig. 1	41
<b>112 38 0020</b>	Dieffenbach skalpel oční bříškatý; 2,0 cm, fig. 2	Dieffenbach knife; 2,0 cm, fig. 2	41
<b>112 38 0030</b>	Dieffenbach skalpel oční bříškatý; 2,5 cm, fig. 4	Dieffenbach knife; 2,5 cm, fig. 4	41
<b>112 38 0040</b>	Dieffenbach skalpel oční bříškatý; 3,0 cm, fig. 5	Dieffenbach knife; 3,0 cm, fig. 5	41
<b>112 38 0110</b>	Dieffenbach skalpel oční hrotnatý; 1,7 cm, fig. 7	Dieffenbach knife; 1,7 cm, fig. 7	41
<b>112 38 0120</b>	Dieffenbach skalpel oční hrotnatý; 2,0 cm, fig. 8	Dieffenbach knife; 2,0 cm, fig. 8	41
<b>112 38 0130</b>	Dieffenbach skalpel oční hrotnatý; 2,5 cm, fig. 9	Dieffenbach knife; 2,5 cm, fig. 9	41
<b>112 38 0140</b>	Dieffenbach skalpel oční hrotnatý; 3,0 cm, fig. 10	Dieffenbach knife; 3,0 cm, fig. 10	41
<b>112 50 0050</b>	Nůž na dáseň oboustranný; 18,0 cm	Gum knife mutual; 18,0 cm	40
<b>112 50 0060</b>	Nůž na gingivektomii fig. 1; 17,3 cm	Gingivectomy knife fig. 1; 17,3 cm	40
<b>112 50 0070</b>	Nůž na gingivektomii fig. 2; 17,3 cm	Gingivectomy knife fig. 2; 17,3 cm	40
<b>112 91 0002</b>	Držátko skalpelových čepelek s měřítkem; fig. 3	Scalpel handle with scale fig. 3	42
<b>112 91 0003</b>	Držátko skalpelových čepelek; fig. 3	Scalpel handle fig. 3	42
<b>112 91 0004</b>	Držátko skalpelových čepelek; fig. 4	Scalpel handle fig. 4	42, 127
<b>112 91 0005</b>	Držátko skalpelových čepelek; fig. 3l	Scalpel handle fig. 3l	42
<b>112 91 0010</b>	Čepelka skalpelová; fig. 10 (baleno po 100 ks)	Scalpel blades fig. 10 (pck=100 pcs)	43
<b>112 91 0011</b>	Čepelka skalpelová; fig. 11 (baleno po 100 ks)	Scalpel blades fig. 11 (pck=100 pcs)	43
<b>112 91 0012</b>	Čepelka skalpelová; fig. 12 (baleno po 100 ks)	Scalpel blades fig. 12 (pck=100 pcs)	43
<b>112 91 0013</b>	Čepelka skalpelová; fig. 13 (baleno po 100 ks)	Scalpel blades fig. 13 (pck=100 pcs)	43
<b>112 91 0015</b>	Čepelka skalpelová; fig. 15 (baleno po 100 ks)	Scalpel blades fig. 15 (pck=100 pcs)	43
<b>112 91 0018</b>	Čepelka skalpelová; fig. 18 (baleno po 100 ks)	Scalpel blades fig. 18 (pck=100 pcs)	43
<b>112 91 0020</b>	Čepelka skalpelová; fig. 20 (baleno po 100 ks)	Scalpel blades fig. 20 (pck=100 pcs)	43
<b>112 91 0021</b>	Čepelka skalpelová; fig. 21 (baleno po 100 ks)	Scalpel blades fig. 21 (pck=100 pcs)	43
<b>112 91 0022</b>	Čepelka skalpelová; fig. 22 (baleno po 100 ks)	Scalpel blades fig. 22 (pck=100 pcs)	43
<b>112 91 0023</b>	Čepelka skalpelová; fig. 23 (baleno po 100 ks)	Scalpel blades fig. 23 (pck=100 pcs)	43
<b>112 91 0024</b>	Čepelka skalpelová; fig. 24 (baleno po 100 ks)	Scalpel blades fig. 24 (pck=100 pcs)	43
<b>112 91 0025</b>	Čepelka skalpelová; fig. 12d (baleno po 100 ks)	Scalpel blades fig. 12d (pck=100 pcs)	43
<b>112 91 0026</b>	Čepelka skalpelová; fig. 15c (baleno po 100 ks)	Scalpel blades fig. 15c (pck=100 pcs)	43
<b>113</b>	<b>Nůžky</b>	<b>Scissors</b>	
<b>113 05 0030</b>	Lister nůžky na obvazy; 15,0 cm	Lister bandage scissors; 15,0 cm	55
<b>113 05 0040</b>	Lister nůžky na obvazy; 20,0 cm	Lister bandage scissors; 20,0 cm	55
<b>113 08 0010</b>	Standard nůžky chirurgické rovné; 13,0 cm	Standard operating scissors; 13,0 cm	58
<b>113 08 0020</b>	Standard nůžky chirurgické rovné; 15,0 cm	Standard operating scissors; 15,0 cm	58
<b>113 08 0040</b>	Standard nůžky chirurgické rovné; 18,5 cm	Standard operating scissors; 18,5 cm	58
<b>113 08 0060</b>	Standard nůžky chirurgické rovné; 22,0 cm	Standard operating scissors; 22,0 cm	58
<b>113 08 0070</b>	Standard nůžky chirurgické rovné; 30,0 cm	Standard operating scissors; 30,0 cm	58
<b>113 08 0110</b>	Standard nůžky chirurgické rovné; 13,0 cm	Standard operating scissors; 13,0 cm	58
<b>113 08 0120</b>	Standard nůžky chirurgické rovné; 15,0 cm	Standard operating scissors; 15,0 cm	58
<b>113 08 0140</b>	Standard nůžky chirurgické rovné; 18,5 cm	Standard operating scissors; 18,5 cm	58
<b>113 08 0160</b>	Standard nůžky chirurgické rovné; 22,0 cm	Standard operating scissors; 22,0 cm	58
<b>113 08 0170</b>	Standard nůžky chirurgické rovné; 30,0 cm	Standard operating scissors; 30,0 cm	58
<b>113 08 0210</b>	Standard nůžky chirurgické rovné; 13,0 cm	Standard operating scissors; 13,0 cm	58
<b>113 08 0220</b>	Standard nůžky chirurgické rovné; 15,0 cm	Standard operating scissors; 15,0 cm	58
<b>113 08 0240</b>	Standard nůžky chirurgické rovné; 18,5 cm	Standard operating scissors; 18,5 cm	58
<b>113 08 0260</b>	Standard nůžky chirurgické rovné; 22,0 cm	Standard operating scissors; 22,0 cm	58
<b>113 08 0270</b>	Standard nůžky chirurgické rovné; 30,0 cm	Standard operating scissors; 30,0 cm	58
<b>113 08 0310</b>	Standard nůžky chirurgické zahnuté; 13,0 cm	Standard operating scissors; 13,0 cm	58
<b>113 08 0320</b>	Standard nůžky chirurgické zahnuté; 15,0 cm	Standard operating scissors; 15,0 cm	58
<b>113 08 0340</b>	Standard nůžky chirurgické zahnuté; 18,5 cm	Standard operating scissors; 18,5 cm	58
<b>113 08 0360</b>	Standard nůžky chirurgické zahnuté; 22,0 cm	Standard operating scissors; 22,0 cm	58
<b>113 08 0370</b>	Standard nůžky chirurgické zahnuté; 30,0 cm	Standard operating scissors; 30,0 cm	58
<b>113 08 0410</b>	Standard nůžky chirurgické zahnuté; 13,0 cm	Standard operating scissors; 13,0 cm	58
<b>113 08 0420</b>	Standard nůžky chirurgické zahnuté; 15,0 cm	Standard operating scissors; 15,0 cm	58
<b>113 08 0440</b>	Standard nůžky chirurgické zahnuté; 18,5 cm	Standard operating scissors; 18,5 cm	58
<b>113 08 0460</b>	Standard nůžky chirurgické zahnuté; 22,0 cm	Standard operating scissors; 22,0 cm	58
<b>113 08 0470</b>	Standard nůžky chirurgické zahnuté; 30,0 cm	Standard operating scissors; 30,0 cm	58
<b>113 08 0510</b>	Standard nůžky chirurgické zahnuté; 13,0 cm	Standard operating scissors; 13,0 cm	58
<b>113 08 0520</b>	Standard nůžky chirurgické zahnuté; 15,0 cm	Standard operating scissors; 15,0 cm	58
<b>113 08 0540</b>	Standard nůžky chirurgické zahnuté; 18,5 cm	Standard operating scissors; 18,5 cm	58
<b>113 08 0560</b>	Standard nůžky chirurgické zahnuté; 22,0 cm	Standard operating scissors; 22,0 cm	58
<b>113 08 0570</b>	Standard nůžky chirurgické zahnuté; 30,0 cm	Standard operating scissors; 30,0 cm	58
<b>113 38 0010</b>	Nůžky rovné; 10,0 cm	Scissors straight; 10,0 cm	61
<b>113 38 0020</b>	Nůžky rovné; 10,0 cm	Scissors straight; 10,0 cm	61
<b>113 38 0030</b>	Nůžky rovné; 10,0 cm	Scissors straight; 10,0 cm	61
<b>113 38 0040</b>	Nůžky zahnuté; 10,0 cm	Scissors curved; 10,0 cm	61
<b>113 38 0050</b>	Nůžky zahnuté; 10,0 cm	Scissors curved; 10,0 cm	61
<b>113 38 0060</b>	Nůžky zahnuté; 10,0 cm	Scissors curved; 10,0 cm	61

číslo – number	název	item	strana – page
113 38 0071	Nůžky rovné; 11,5 cm	Scissors straight; 11,5 cm	61
113 38 0081	Nůžky rovné; 11,5 cm	Scissors straight; 11,5 cm	61
113 38 0091	Nůžky zahnuté; 11,5 cm	Scissors curved; 11,5 cm	61
113 38 0100	Nůžky zahnuté; 11,5 cm	Scissors curved; 11,5 cm	61
113 38 0150	Nůžky rovné; 11,5 cm	Scissors straight; 11,5 cm	61
113 38 0161	Nůžky zahnuté; 11,5 cm	Scissors curved; 11,5 cm	61
113 38 0210	Nůžky lomené; 10,5 cm	Scissors angled; 10,5 cm	61
113 38 0260	Nůžky lomené; 10,5 cm	Scissors angled; 10,5 cm	61
113 38 0311	Nůžky; 11,5 cm	Scissors; 11,5 cm	61
113 38 1020	Castroviejo nůžky oční zahnuté; 9,0 cm	Castroviejo eye scissors; 9,0 cm	62
113 38 1030	Castroviejo nůžky oční lomené; 9,0 cm	Castroviejo eye scissors; 9,0 cm	62
113 50 0010	Nůžky na daseň rovné; 12,0 cm	Gum scissors; 12,0 cm	56
113 50 0020	Nůžky na daseň zahnuté; 12,0 cm	Gum scissors; 12,0 cm	56
113 50 0030	Nůžky na daseň rovné; 14,5 cm	Gum scissors; 14,5 cm	56
113 50 0040	Nůžky na daseň zahnuté; 14,5 cm	Gum scissors; 14,5 cm	56
113 52 0150	Nůžky na korunky rovné; 11,0 cm	Crown scissors; 11,0 cm	122
113 52 0160	Nůžky na korunky zahnuté; 11,0 cm	Crown scissors; 11,0 cm	122
113 91 0002	Standard nůžky chirurgické rovné; 11,5 cm	Standard operating scissors; 11,5 cm	59
113 91 0006	Standard nůžky chirurgické rovné; 16,5 cm	Standard operating scissors; 16,5 cm	59
113 91 0009	Standard nůžky chirurgické rovné; 20,0 cm	Standard operating scissors; 20,0 cm	59
113 91 0011	Standard nůžky chirurgické zahnuté; 11,5 cm	Standard operating scissors; 11,5 cm	59
113 91 0015	Standard nůžky chirurgické zahnuté; 16,5 cm	Standard operating scissors; 16,5 cm	59
113 91 0018	Standard nůžky chirurgické zahnuté; 20,0 cm	Standard operating scissors; 20,0 cm	59
113 91 0020	Nůžky chirurgické rovné; 11,5 cm	Operating scissors; 11,5 cm	59
113 91 0026	Nůžky chirurgické rovné; 16,5 cm	Operating scissors; 16,5 cm	59
113 91 0029	Nůžky chirurgické rovné; 20,0 cm	Operating scissors; 20,0 cm	59
113 91 0031	Nůžky chirurgické zahnuté; 11,5 cm	Operating scissors; 11,5 cm	59
113 91 0037	Nůžky chirurgické zahnuté; 16,5 cm	Operating scissors; 16,5 cm	59
113 91 0040	Nůžky chirurgické zahnuté; 20,0 cm	Operating scissors; 20,0 cm	59
113 91 0042	Nůžky chirurgické rovné; 11,5 cm	Operating scissors; 11,5 cm	59
113 91 0046	Nůžky chirurgické rovné; 16,5 cm	Operating scissors; 16,5 cm	59
113 91 0049	Nůžky chirurgické rovné; 20,0 cm	Operating scissors; 20,0 cm	59
113 91 0051	Nůžky chirurgické zahnuté; 11,5 cm	Operating scissors; 11,5 cm	59
113 91 0055	Nůžky chirurgické zahnuté; 16,5 cm	Operating scissors; 16,5 cm	59
113 91 0058	Nůžky chirurgické zahnuté; 20,0 cm	Operating scissors; 20,0 cm	59
113 91 0221	Sanvenero nůžky preparační hrotnaté rovné; 14,0 cm	Sanvenero dissecting scissors; 14,0 cm	57
113 91 0222	Sanvenero nůžky preparační hrotnaté zahnuté; 14,0 cm	Sanvenero dissecting scissors; 14,0 cm	57
113 91 0233	Reynolds nůžky preparační ostré rovné; 15,0 cm	Reynolds dissecting scissors; 15,0 cm	57
113 91 0235	Reynolds nůžky preparační ostré zahnuté; 15,0 cm	Reynolds dissecting scissors; 15,0 cm	57
113 91 0328	Wagner nůžky jemné hrotnaté rovné; 12,0 cm	Wagner fine scissors straight; 12,0 cm	60
113 91 0331	Wagner nůžky jemné hrotnaté zahnuté; 12,0 cm	Wagner fine scissors curved; 12,0 cm	60
113 91 0348	Walton nůžky jemné hrotnaté zahnuté; 10,0 cm	Walton fine scissors sharp curved; 10,0 cm	60
113 91 0349	Mod. Bonn nůžky extra jemné rovné; 8,0 cm	Mod. Bonn extra delicate scissors straight; 8,0 cm	60
113 91 0350	Mod. Bonn nůžky extra jemné zahnuté; 8,0 cm	Mod. Bonn extra delicate scissors curved; 8,0 cm	60
113 91 0399	Spencer nůžky pro ligaturu; 9 cm	Spencer ligature scissors; 9,0 cm	57
113 91 0400	Spencer nůžky pro ligaturu; 10,5 cm	Spencer ligature scissors; 10,5 cm	57
113 91 0403	Littauer nůžky pro ligaturu; 14,0 cm	Littauer ligature scissors; 14,0 cm	57
113 91 0474	Goldman-Fox nůžky na daseň rovné; 13,0 cm	Goldman-Fox scissors; 13,0 cm	56
113 91 0475	Goldman-Fox nůžky na daseň zahnuté; 13,0 cm	Goldman-Fox scissors; 13,0 cm	56
113 91 0483	Quinby nůžky na daseň rovné; 12,0 cm	Quinby gum scissors; 12,0 cm	56
113 91 0484	Quinby nůžky na daseň zahnuté; 12,0 cm	Quinby gum scissors; 12,0 cm	56
113 91 0490	Noyes nůžky na duhovku hrotnaté rovné; 12,0 cm	Noyes iris scissors; 12,0 cm	62
113 91 0492	Noyes nůžky na duhovku hrotnatotupé rovné; 12,0 cm	Noyes iris scissors; 12,0 cm	62
113 91 0494	Noyes nůžky na duhovku tupé rovné; 12,0 cm	Noyes iris scissors; 12,0 cm	62
113 91 0502	Castroviejo nůžky na duhovku ostré rovné; 9,0 cm	Castroviejo iris scissors; 9,0 cm	62
113 91 0503	Castroviejo nůžky na duhovku tupé rovné; 9,0 cm	Castroviejo iris scissors; 9,0 cm	62
113 91 0505	Castroviejo nůžky na duhovku tupé lomené; 9,0 cm	Castroviejo iris scissors; 9,0 cm	62
113 91 0507	Castroviejo nůžky na duhovku hrotnaté; 10,0 cm	Castroviejo iris scissors; 10,0 cm	62
113 91 0508	Castroviejo nůžky na duhovku tupé; 10,0 cm	Castroviejo iris scissors; 10,0 cm	62
113 91 0537	Gomel nůžky mikro tupé; 14,5 cm	Gomel dissection micro scissors; 14,5 cm	63
113 91 0538	Gomel nůžky mikro tupé; 18,0 cm	Gomel dissection micro scissors; 18,0 cm	63
113 91 0539	Gomel nůžky mikro hrotnaté; 14,5 cm	Gomel dissection micro scissors; 14,5 cm	63
113 91 0540	Gomel nůžky mikro hrotnaté; 18,0 cm	Gomel dissection micro scissors; 18,0 cm	63
113 91 0552	Nůžky mikro; rovné 18,5 cm	Dissection micro scissors; straight 18,5 cm	63
113 91 0553	Nůžky mikro; zahnuté 18,5 cm	Dissection micro scissors; curved 18,5 cm	63
113 91 0685	Stille nůžky micro super cut rovné; 10 cm	Stille scissors micro super cut straight; 10 cm	60
113 91 0686	Stille nůžky micro super cut zahnuté; 10 cm	Stille scissors micro super cut curved; 10 cm	60
113 91 0687	Jabaley-Stille nůžky micro super cut rovné; 12 cm	Jabaley-Stille scissors micro super cut straight; 12 cm	60
113 91 0688	Jabaley-Stille nůžky micro super cut zahnuté; 12 cm	Jabaley-Stille scissors micro super cut curved; 12 cm	60
113 91 0689	Stevens nůžky micro super cut rovné; 12,5 cm	Stevens scissors micro super cut straight; 12,5 cm	60
113 91 0690	Stevens nůžky micro super cut zahnuté; 12,5 cm	Stevens scissors micro super cut curved; 12,5 cm	60
<b>114</b>	<b>Pinzety</b>	<b>Forceps</b>	
114 08 0030	Standard pinzeta anatomická; 16,0 cm	Tissue forceps; 16,0 cm	66
114 08 0040	Standard pinzeta anatomická; 20,0 cm	Tissue forceps; 20,0 cm	66
114 08 0050	Standard pinzeta anatomická; 25,0 cm	Tissue forceps; 25,0 cm	66
114 08 0060	Standard pinzeta anatomická; 30,0 cm	Tissue forceps; 30,0 cm	66
114 08 0090	Pinzeta anatomická rovná jemná; 14,5 cm	Tissue forceps; 14,5 cm	65



číslo – number	název	item	strana – page
114 08 0101	Pinzeta anatomická jemná; 14,5 cm	Tissue forceps; 14,5 cm	65, 127
114 08 0140	Pinzeta anatomická jemná; 20,0 cm	Tissue forceps; 20,0 cm	65
114 08 0231	Pinzeta anatomická velmi jemná; 14,5 cm	Tissue forceps; 14,5 cm	65
114 08 0240	Pinzeta anatomická velmi jemná; 20,0 cm	Tissue forceps; 20,0 cm	65
114 08 0250	Pinzeta anatomická velmi jemná; 24,5 cm	Tissue forceps; 24,5 cm	65
114 08 0340	Standard pinzeta chirurgická; 20,0 cm	Dressing forceps; 20,0 cm	66
114 08 0350	Standard pinzeta chirurgická; 25,0 cm	Dressing forceps; 25,0 cm	66
114 08 0360	Standard pinzeta chirurgická; 30,0 cm	Dressing forceps; 30,0 cm	66
114 08 0381	Standard pinzeta chirurgická; 14,5 cm	Dressing forceps; 14,5 cm	66
114 08 0430	Standard pinzeta chirurgická jemná; 16,0 cm	Dressing forceps; 16,0 cm	67
114 08 0530	Pinzeta chirurgická velmi jemná; 1x2 zuby; 14,5 cm	Tissue forceps; 1x2 teeth; 14,5 cm	67
114 14 0100	Pinzeta cévní atraumatická rovná; 2,0 mm; 14,5 cm	Non-traumatic forceps; 2,0 mm; 14,5 cm	69
114 14 0300	Pinzeta cévní atraumatická rovná jemná; 14,5 cm	Non-traumatic forceps; 14,5 cm	69
114 38 0010	Graefe pinzeta oční rovná; 10,5 cm	Graefe eye forceps; 10,5 cm	70
114 38 0020	Graefe pinzeta oční rovná jemná; 10,5 cm	Graefe eye forceps; 10,5 cm	70
114 38 0100	Graefe pinzeta oční zahnutá jemná; 10,5 cm	Graefe eye forceps; 10,5 cm	70
114 38 0150	Graefe pinzeta oční rovná; 1x2 zuby; 10,5 cm	Graefe eye forceps; 1x2 teeth; 10,5 cm	70
114 38 0160	Graefe pinzeta oční rovná jemná; 1x2 zuby; 10,5 cm	Graefe eye forceps; 1x2 teeth; 10,5 cm	70
114 38 0360	Graefe pinzeta fixační s uzávěrem s perem; 11,0 cm	Graefe fixation forceps; 11,0 cm	70
114 50 0011	Pinzeta zubní s rýhovanou čelistí zahnutá; 15,7 cm	Dental forceps curved; 15,7 cm	64, 76, 124
114 50 0021	Pinzeta zubní s rýhovanou čelistí lomená; 15,7 cm	Dental forceps angled; 15,7 cm	64
114 50 0031	Pinzeta zubní s hladkou čelistí lomená; 15,7 cm	Dental forceps angled; 15,7 cm	64
114 50 0051	Pinzeta na kořenové čípky; 15,7 cm	Root suppository forceps; 15,7 cm	64
114 50 0150	Pinzeta zubní chirurgická zahnutá jemná; 14,2 cm	Dental forceps; 14,2 cm	64
114 50 0170	Pinzeta zubní chirurgická zahnutá; 15,7 cm	Dental forceps; 15,7 cm	64
114 50 1030	Pinzeta zubní lomená Dia; 15,7 cm	Dental forceps Dia; 15,7 cm	64
114 52 0020	Pinzeta laboratorní hrotnatá; 12,5 cm	Laboratory forceps; 12,5 cm	121
114 52 0030	Pinzeta laboratorní; 0,3 mm; 12,5 cm	Laboratory forceps; 0,3 mm; 12,5 cm	121
114 52 0040	Pinzeta laboratorní; 0,4 mm; 12,5 cm	Laboratory forceps; 0,4 mm; 12,5 cm	121
114 52 0050	Pinzeta laboratorní; 0,3 mm; 11,0 cm	Laboratory forceps; 0,3 mm; 11,0 cm	121
114 52 0060	Pinzeta laboratorní; 0,4 mm; 11,0 cm	Laboratory forceps; 0,4 mm; 11,0 cm	121
114 52 0100	Pinzeta zkřížená; 15,3 cm	Cross-action forceps; 15,3 cm	121
114 52 0101	Pinzeta zkřížená; 15,3 cm	Cross-action forceps; 15,3 cm	121
114 52 0110	Pinzeta zkřížená se šroubovákem; 15,5 cm	Cross-action forceps with screwdriver; 15,5 cm	121
114 91 0002	Standard pinzeta chirurgická; 11,5 cm	Dressing forceps; 11,5 cm	66
114 91 0003	Standard pinzeta chirurgická; 13,0 cm	Dressing forceps; 13,0 cm	66
114 91 0004	Standard pinzeta chirurgická; 14,5 cm	Dressing forceps; 14,5 cm	66
114 91 0006	Standard pinzeta chirurgická; 18,0 cm	Dressing forceps; 18,0 cm	66
114 91 0011	Standard pinzeta chirurgická; 11,5 cm	Dressing forceps; 11,5 cm	66
114 91 0012	Standard pinzeta chirurgická; 13,0 cm	Dressing forceps; 13,0 cm	66
114 91 0015	Standard pinzeta chirurgická; 18,0 cm	Dressing forceps; 18,0 cm	66
114 91 0255	Pinzeta šicí rovná; 0,3 mm; 12,0 cm	Suture tying forceps; 0,3 mm; 12,0 cm	67
114 91 0256	Pinzeta šicí rovná; 0,3 mm; 15,0 cm	Suture tying forceps; 0,3 mm; 15,0 cm	67
114 91 0257	Pinzeta šicí zahnutá; 0,3 mm; 12,0 cm	Suture tying forceps; 0,3 mm; 12,0 cm	67
114 91 0258	Pinzeta šicí zahnutá; 0,3 mm; 15,0 cm	Suture tying forceps; 0,3 mm; 15,0 cm	67
114 91 0451	De Bakey pinzeta atraumatická rovná; 1,5 mm; 16,0 cm	De Bakey atrauma forceps; 1,5 mm; 16,0 cm	69
114 91 0453	De Bakey pinzeta atraumatická rovná; 1,5 mm; 20,0 cm	De Bakey atrauma forceps; 1,5 mm; 20,0 cm	69
114 91 0454	De Bakey pinzeta atraumatická rovná; 1,5 mm; 24,0 cm	De Bakey atrauma forceps; 1,5 mm; 24,0 cm	69
114 91 0455	De Bakey pinzeta atraumatická rovná; 2,0 mm; 16,0 cm	De Bakey atrauma forceps; 2,0 mm; 16,0 cm	69
114 91 0457	De Bakey pinzeta atraumatická rovná; 2,0 mm; 20,0 cm	De Bakey atrauma forceps; 2,0 mm; 20,0 cm	69
114 91 0458	De Bakey pinzeta atraumatická rovná; 2,0 mm; 24,0 cm	De Bakey atrauma forceps; 2,0 mm; 24,0 cm	69
114 91 0467	De Bakey pinzeta atraumatická zahnutá; 2,0 mm; 16,0 cm	De Bakey atrauma forceps; 2,0 mm; 16,0 cm	69
114 91 0469	De Bakey pinzeta atraumatická zahnutá; 2,0 mm; 20,0 cm	De Bakey atrauma forceps; 2,0 mm; 20,0 cm	69
114 91 0470	De Bakey pinzeta atraumatická zahnutá; 2,0 mm; 24,0 cm	De Bakey atrauma forceps; 2,0 mm; 24,0 cm	69
114 91 0477	Oehler pinzeta chirurgická tvrdokov; 1x2 zuby; 14,0 cm	Oehler tissue forceps TUC; 1x2 teeth; 14,0 cm	68
114 91 0478	Oehler pinzeta chirurgická tvrdokov; 1x2 zuby; 16,0 cm	Oehler tissue forceps TUC; 1x2 teeth; 16,0 cm	68
114 91 0479	Oehler pinzeta chirurgická tvrdokov; 1x2 zuby; 18,0 cm	Oehler tissue forceps TUC; 1x2 teeth; 18,0 cm	68
114 91 0480	Oehler pinzeta chirurgická tvrdokov; 1x2 zuby; 20,0 cm	Oehler tissue forceps TUC; 1x2 teeth; 20,0 cm	68
114 91 0481	Oehler pinzeta chirurgická tvrdokov; 1x2 zuby; 25,0 cm	Oehler tissue forceps TUC; 1x2 teeth; 25,0 cm	68
114 91 0482	Oehler pinzeta chirurgická tvrdokov; 1x2 zuby; 30,0 cm	Oehler tissue forceps TUC; 1x2 teeth; 30,0 cm	68
114 91 0483	Semken pinzeta anatomická tvrdokov; 12,5 cm	Semken dissecting forceps TUC; 12,5 cm	68
114 91 0484	Semken pinzeta anatomická tvrdokov; 15,5 cm	Semken dissecting forceps TUC; 15,5 cm	68
114 91 0485	Gillies pinzeta chirurgická tvrdokov; 1x2 zuby; 15,0 cm	Gillies tissue forceps TUC; 1x2 teeth; 15,0 cm	68
114 91 0486	Jeweler pinzeta tvrdokov; 15,0 cm	Jeweler forceps TUC; 15,0 cm	68
114 91 0487	Adson pinzeta anatomická tvrdokov; 12,0 cm	Adson forceps TUC; 12,0 cm	68
114 91 0489	Adson pinzeta anatomická tvrdokov; 15,0 cm	Adson forceps TUC; 15,0 cm	68
114 91 0490	Adson pinzeta chirurgická tvrdokov; 1x2 zuby; 12,0 cm	Adson forceps TUC; 1x2 teeth; 12,0 cm	68
114 91 0491	Adson pinzeta chirurgická tvrdokov; 1x2 zuby; 15,0 cm	Adson forceps TUC; 1x2 teeth; 15,0 cm	68
<b>115</b>	<b>Svorky</b>	<b>Clamps, Forceps</b>	
115 08 0010	Mosquito-Halsted svorka na cévy rovná; 12,0 cm	Mosquito-Halsted artery forceps; 12,0 cm	44, 127
115 08 0020	Mosquito-Halsted svorka na cévy zahnutá; 12,0 cm	Mosquito-Halsted artery forceps; 12,0 cm	44, 124
115 08 0030	Mosquito-Halsted svorka na cévy rovná; 12,0 cm	Mosquito-Halsted artery forceps; 12,0 cm	44
115 08 0040	Mosquito-Halsted svorka na cévy rovná; 12,0 cm	Mosquito-Halsted artery forceps; 12,0 cm	44
115 08 0050	Mosquito-Halsted svorka na cévy zahnutá; 12,0 cm	Mosquito-Halsted artery forceps; 12,0 cm	44
115 08 0060	Mosquito-Halsted svorka na cévy zahnutá; 12,0 cm	Mosquito-Halsted artery forceps; 12,0 cm	44
115 08 0260	Rochester-Pean svorka na cévy zahnutá; 14,0 cm	Rochester-Pean artery forceps; 14,0 cm	46
115 08 0500	Kelly svorka na cévy zahnutá; 14,0 cm	Kelly artery forceps; 14,0 cm	46

číslo – number	název	item	strana – page
115 08 0780	Backhaus svorka na prádlo; 11,8 cm	Backhaus towel forceps; 11,8 cm	48
115 08 0790	Backhaus svorka na prádlo; 12,0 cm	Backhaus towel forceps; 12,0 cm	48
115 08 0810	Backhaus svorka na prádlo; 8,0 cm	Backhaus towel forceps; 8,0 cm	48
115 08 0820	Backhaus svorka na prádlo; 13,0 cm	Backhaus towel forceps; 13,0 cm	48
115 08 1010	Mosquito-Halsted svorka na cévy rovná; 12,0 cm	Mosquito-Halsted artery forceps; 12,0 cm	44
115 08 1020	Mosquito-Halsted svorka na cévy zahnutá; 12,0 cm	Mosquito-Halsted artery forceps; 12,0 cm	44
115 08 1030	Mosquito-Halsted svorka na cévy rovná; 12,0 cm	Mosquito-Halsted artery forceps; 12,0 cm	44
115 08 1050	Mosquito-Halsted svorka na cévy zahnutá; 12,0 cm	Mosquito-Halsted artery forceps; 12,0 cm	44
115 91 0068	Hartmann svorka rovná; 10,0 cm	Hartmann forceps; 10,0 cm	45
115 91 0069	Hartmann svorka zahnutá; 10,0 cm	Hartmann forceps; 10,0 cm	45
115 91 0073	Micro-Mosquito svorka na cévy rovná; 12,0 cm	Micro-Mosquito artery forceps; 12,0 cm	45
115 91 0075	Micro-Mosquito svorka na cévy zahnutá; 12,0 cm	Micro-Mosquito artery forceps; 12,0 cm	45
115 91 0077	Micro-Mosquito svorka rovná 1×2 zuby; 12,0 cm	Micro-Mosquito artery forceps; 1×2 teeth; 12,0 cm	45
115 91 0079	Micro-Mosquito svorka zahnutá 1×2 zuby; 12,0 cm	Micro-Mosquito artery forceps; 1×2 teeth; 12,0 cm	45
115 91 0080	Halsted-Mosquito svorka na cévy rovná; 12,5 cm	Halsted-Mosquito artery forceps straight; 12,5 cm	45
115 91 0082	Halsted-Mosquito svorka na cévy zahnutá; 12,5 cm	Halsted-Mosquito artery forceps curved; 12,5 cm	45
115 91 0084	Halsted-Mosquito svorka; 1×2 zuby rovná; 12,5 cm	Halsted-Mosquito artery forceps straight; 1×2 teeth; 12,5 cm	45
115 91 0086	Halsted-Mosquito svorka zahnutá; 1×2 zuby; 12,5 cm	Halsted-Mosquito artery forceps curved; 1×2 teeth; 12,5 cm	45
115 91 0341	Backhaus-Clip svorka na prádlo; 11,0 cm	Backhaus-Clip towel forceps; 11,0 cm	48
115 91 0343	Backhaus svorka na prádlo; 11,0 cm	Backhaus towel forceps; 11,0 cm	48
115 91 0345	Backhaus svorka na prádlo; 15,0 cm	Backhaus towel forceps; 15,0 cm	48
115 91 0348	Roeder svorka na prádlo; 13,0 cm	Roeder towel forceps; 13,0 cm	49
115 91 0349	Roeder svorka na prádlo; 15,0 cm	Roeder towel forceps; 15,0 cm	49
115 91 0350	Lorna svorka na prádlo; 10,0 cm	Lorna towel forceps; 10,0 cm	49
115 91 0351	Lorna svorka na prádlo; 13,0 cm	Lorna towel forceps; 13,0 cm	49
115 91 0352	Tohoku-Japan svorka na prádlo; 10,0 cm	Tohoku-Japan towel forceps; 10,0 cm	49
115 91 0353	Tohoku-Japan svorka na prádlo; 13,0 cm	Tohoku-Japan towel forceps; 13,0 cm	49
115 91 0354	Peers svorka na prádlo; 10,0 cm	Peers towel forceps; 10,0 cm	49
115 91 0382	Babcock svorka chirurgická; 16,0 cm	Babcock tissue seizing forceps; 16,0 cm	46
115 91 0591	De Bakey-Pean svorka atraumatická; 14,0 cm	De Bakey-Pean atrauma forceps; 14,0 cm	47
115 91 0592	De Bakey-Pean svorka atraumatická; 14,0 cm	De Bakey-Pean atrauma forceps; 14,0 cm	47
115 91 0596	De Bakey-Mosquito svorka atraumatická; 12,0 cm	De Bakey-Mosquito atrauma forceps; 12,0 cm	47
115 91 0625	De Bakey-Rankin svorka atraumatická; 16,0 cm	De Bakey-Rankin atrauma forceps; 16,0 cm	47
115 91 0626	De Bakey-Rankin svorka atraumatická; 16,0 cm	De Bakey-Rankin atrauma forceps; 16,0 cm	47
115 91 0627	De Bakey-Mosquito svorka atraumatická; 15,0 cm	De Bakey-Mosquito atrauma forceps; 15,0 cm	47
115 91 0628	De Bakey-Mosquito svorka atraumatická; 15,0 cm	De Bakey-Mosquito atrauma forceps; 15,0 cm	47
115 91 0629	De Bakey-Mosquito svorka atraumatická; 12,0 cm	De Bakey-Mosquito atrauma forceps; 12,0 cm	47
115 91 0630	De Bakey-Pean svorka atraumatická; 16,0 cm	De Bakey-Pean atrauma forceps; 16,0 cm	47
115 91 0632	De Bakey-Pean svorka atraumatická; 16,0 cm	De Bakey-Pean atrauma forceps; 16,0 cm	47
<b>116</b>	<b>Kleště štípací</b>	<b>Bone Rongeurs</b>	
116 08 0030	Luer kleště štípací na kosti rovné; 17,0 cm	Luer bone rongeurs; 17,0 cm	17
116 08 0070	Luer kleště štípací na kosti silně Zahn; 15,0 cm	Luer bone rongeurs; 15,0 cm	17
116 08 0080	Luer kleště štípací na kosti zahnuté; 14,5 cm	Luer bone rongeurs; 14,5 cm	17
116 08 0280	Kleště štípací; 14,0 cm	Bone rongeurs; 14,0 cm	18
116 08 0410	Liston kleště štípací rovné; 14,0 cm	Liston bone rongeurs; 14,0 cm	18
116 08 0440	Liston kleště štípací rovné; 19,0 cm	Liston bone rongeurs; 19,0 cm	18
116 08 0450	Liston kleště štípací zahnuté; 19,0 cm	Liston bone rongeurs; 19,0 cm	18
116 29 0410	Jansen kleště štípací fig. 2; 18,0 cm	Jansen mastoid forceps fig. 2; 18,0 cm	17
116 91 0001	Kleště štípací na drát; 14,5 cm	Wire cutting forceps; 14,5 cm	115
116 91 0017	Mini-Friedman kleště štípací na kosti; 12,0 cm	Mini-Friedman bone ronguers; 12,0 cm	16
116 91 0514	Friedman kleště štípací na kosti; 14,0 cm	Friedman bone ronguers; 14,0 cm	16
116 91 0515	Stellbrink kleště štípací na kosti; 17,0 cm	Stellbrink bone ronguers; 17,0 cm	16
116 91 0516	Stellbrink kleště štípací na kosti; 17,0 cm	Stellbrink bone ronguers; 17,0 cm	16
116 91 0518	Cleveland kleště štípací na kosti; 17,0 cm	Cleveland bone ronguers; 17,0 cm	16
116 91 0522	Blumenthal kleště štípací na kosti; 15,5 cm	Blumenthal bone ronguers; 15,5 cm	16
116 91 0523	Blumenthal kleště štípací na kosti; 15,5 cm	Blumenthal bone ronguers; 15,5 cm	16
116 91 0524	Blumenthal kleště štípací na kosti; 15,5 cm	Blumenthal bone ronguers; 15,5 cm	16
116 91 0527	Luer kleště štípací na kosti; 15,0 cm	Luer bone ronguers; 15,0 cm	16
116 91 0528	Luer kleště štípací na kosti; 15,0 cm	Luer bone ronguers; 15,0 cm	16
116 91 0529	Luer kleště štípací na kosti; 15,0 cm	Luer bone ronguers; 15,0 cm	16
<b>117</b>	<b>Kleště úchopné, extrakční</b>	<b>Grasping Forceps, Extraction Forceps</b>	
117 31 0010	Collin kleště na jazyk okénkové; 16,7 cm	Collin tongue holding forceps; 16,7 cm	19
117 31 0030	Löbker kleště na jazyk jednoháčkové; 15,0 cm	Löbker tongue holding forceps; 15,0 cm	19
117 50 0010	Kleště extrakční D2	Extraction forceps D2	11
117 50 0020	Kleště extrakční D7	Extraction forceps D7	11
117 50 0030	Kleště extrakční D17	Extraction forceps D17	11
117 50 0040	Kleště extrakční D18	Extraction forceps D18	12
117 50 0050	Kleště extrakční D67	Extraction forceps D67	13
117 50 0060	Kleště extrakční D30S	Extraction forceps D30S	12
117 50 0150	Kleště extrakční D13	Extraction forceps D13	11
117 50 0160	Kleště extrakční D22	Extraction forceps D22	12
117 50 0170	Kleště extrakční D73	Extraction forceps D73	14
117 50 0180	Kleště extrakční D79	Extraction forceps D79	14
117 50 0190	Kleště extrakční D33A	Extraction forceps D33a	13
117 50 0200	Kleště extrakční D33	Extraction forceps D33	12
117 50 0250	Kleště extrakční D51A	Extraction forceps D51A	13
117 50 0260	Kleště extrakční D51	Extraction forceps D51	13

číslo – number	název	item	strana – page
117 50 0300	Kleště extrakční D342	Extraction forceps D342	15
117 50 0310	Kleště extrakční D339	Extraction forceps D339	15
117 50 0330	Kleště extrakční D74N	Extraction forceps D74N	14
117 50 0340	Kleště extrakční D74M	Extraction forceps D74M	14
117 50 0350	Kleště extrakční D74	Extraction forceps D74	14
117 50 1010	Kleště extrakční D2 diamantované	Extraction forceps D2 diamond	11
117 50 1020	Kleště extrakční D7 diamantované	Extraction forceps D7 diamond	11
117 50 1030	Kleště extrakční D17 diamantované	Extraction forceps D17 diamond	11
117 50 1040	Kleště extrakční D18 diamantované	Extraction forceps D18 diamond	12
117 50 1050	Kleště extrakční D67 diamantované	Extraction forceps D67 diamond	13
117 50 1060	Kleště extrakční D30S diamantované	Extraction forceps D30S diamond	12
117 50 1150	Kleště extrakční D13 diamantované	Extraction forceps D13 diamond	11
117 50 1160	Kleště extrakční D22 diamantované	Extraction forceps D22 diamond	12
117 50 1170	Kleště extrakční D73 diamantované	Extraction forceps D73 diamond	14
117 50 1180	Kleště extrakční D79 diamantované	Extraction forceps D79 diamond	14
117 50 1190	Kleště extrakční D33A diamantované	Extraction forceps D33A diamond	13
117 50 1200	Kleště extrakční D33 diamantované	Extraction forceps D33 diamond	12
117 50 1250	Kleště extrakční D51A diamantované	Extraction forceps D51A diamond	13
117 50 1260	Kleště extrakční D51 diamantované	Extraction forceps D51 diamond	13
117 50 1300	Kleště extrakční D342 diamantované	Extraction forceps D342 diamond	15
117 50 1310	Kleště extrakční D339 diamantované	Extraction forceps D339 diamond	15
117 50 1330	Kleště extrakční D74N diamantované	Extraction forceps D74N diamond	14
117 50 1340	Kleště extrakční D74M diamantované	Extraction forceps D74M diamond	14
117 50 1350	Kleště extrakční D74 diamantované	Extraction forceps D74 diamond	14
117 51 0600	Kleště k odstranění kořen.nástrojů rovné; 13,5 cm	Forceps for extraction of root instruments; 13,5 cm	15
117 51 0610	Kleště k odstranění kořen.nástrojů zahnuté; 13,5 cm	Forceps for extraction of root instruments; 13,5 cm	15
117 51 1600	Kleště k odstranění kořen.nástrojů rovné Dia; 13,5 cm	Forceps for extraction of root instruments straight Dia; 13,5 cm	15
117 51 1610	Kleště k odstranění kořen.nástrojů zahnuté Dia; 13,3 cm	Forceps for extraction of root instruments curved Dia; 13,3 cm	15
117 52 0700	Kleště laboratorní fig. 1; 13,5 cm	Laboratory forceps fig. 1; 13,5 cm	116, 124
117 52 0770	Kleště na kelímky; 50,0 cm	Crucible forceps; 50,0 cm	115
117 52 0780	Kleště na kelímky; 27,5 cm	Crucible forceps; 27,5 cm	115
117 52 0800	Kleště laboratorní ploché; 13,4 cm	Laboratory forceps with flat jaws; 13,4 cm	116
117 52 0810	Kleště laboratorní oblé; 13,4 cm	Laboratory forceps with rounded jaws; 13,4 cm	116
117 52 0820	Kleště laboratorní kuželové; 13,4 cm	Laboratory forceps with conical jaws; 13,4 cm	116
117 52 0830	Kleště laboratorní čočkové; 13,4 cm	Laboratory forceps with lens jaws; 13,4 cm	116
117 52 0840	Kleště laborat.ploché vroubk.čelis. fig. 1; 13,5 cm	Laboratory forceps with flat jaws fig. 1; 13,5 cm	117
117 52 0850	Kleště laborat.ohýbací se žlábkem fig. 2; 13,3 cm	Laboratory forceps with groove jaws fig. 2; 13,3 cm	117
117 52 0860	Kleště laborat.ohýbací se žlábkem fig. 3; 13,0 cm	Laboratory forceps with groove jaws fig. 3; 13,0 cm	117
117 52 0870	Kleště laboratorní ploché fig. 4; 13,0 cm	Laboratory forceps with flat jaws fig. 4; 13,0 cm	117
117 52 0880	Kleště laboratorní ohýbací velké fig. 5; 12,2 cm	Laboratory bending forceps fig. 5; 12,2 cm	118
117 52 0890	Kleště laboratorní ohýbací malé fig. 6; 11,9 cm	Laboratory bending forceps fig. 6; 11,9 cm	118
117 52 1000	Kleště laboratorní utahovací; 13,6 cm	Laboratory tighten forceps; 13,6 cm	118
117 52 1010	Kleště laboratorní ohýbací; 13,6 cm	Laboratory bending forceps; 13,6 cm	118
117 91 0001	Lister kleště tamponové; 13,0 cm	Lister sinus forceps; 13,0 cm	19
117 91 0002	Lister kleště tamponové; 16,0 cm	Lister sinus forceps; 16,0 cm	19
117 91 0003	Lister kleště tamponové; 18,0 cm	Lister sinus forceps; 18,0 cm	19
117 91 0038	Heywood-Smith kleště tamponové; 21,0 cm	Heywood-Smith sponge holding forceps; 21,0 cm	19
117 91 0039	Heywood-Smith kleště tamponové; 25,0 cm	Heywood-Smith sponge holding forceps; 25,0 cm	19
<b>118</b>	<b>Háky</b>	<b>Hooks, Retractors</b>	
118 08 0010	Háček na rány jednozubý ostrý; 16,0 cm	Delicate hook one-pronged sharp; 16,0 cm	31
118 08 0020	Háček na rány dvouzubý ostrý; 16,0 cm	Delicate hook two-pronged sharp; 16,0 cm	31
118 08 0050	Háček na rány jednozubý tupý; 16,0 cm	Delicate hook one-pronged blunt; 16,0 cm	31
118 08 0060	Háček na rány dvouzubý tupý; 16,0 cm	Delicate hook two-pronged blunt; 16,0 cm	31
118 08 0650	Middeldorpf hák na rány okénk.; 14x12 mm; 22,0 cm	Middeldorpf retractor; 14x12 mm; 22,0 cm	34
118 08 0660	Middeldorpf hák na rány okénk.; 21x21 mm; 22,0 cm	Middeldorpf retractor; 21x21 mm; 22,0 cm	34
118 08 0670	Middeldorpf hák na rány okénk.; 32x31 mm; 23,5 cm	Middeldorpf retractor; 32x31 mm; 23,5 cm	34
118 08 0680	Middeldorpf hák na rány okénk.; 62x50 mm; 28,0 cm	Middeldorpf retractor; 62x50 mm; 28,0 cm	34
118 08 0800	Langenbeck hák na rány; 40x10 mm; 21,0 cm	Langenbeck retractor; 40x10 mm; 21,0 cm	35
118 08 0810	Langenbeck hák na rány; 42x13 mm; 21,0 cm	Langenbeck retractor; 42x13 mm; 21,0 cm	35
118 12 0010	Háček pro plastiku jednozubý ostrý fig. 1; 16,0 cm	Plastic hook one-pronged sharp; fig. 1; 16,0 cm	33
118 12 0020	Háček pro plastiku jednozubý ostrý fig. 2; 16,0 cm	Plastic hook one-pronged sharp; fig. 2; 16,0 cm	33
118 12 0050	Háček pro plastiku dvouzubý tupý; 5,0 mm; 16,0 cm	Plastic hook 2 prongs blunt; 5,0 mm; 16,0 cm	33
118 12 0060	Háček pro plastiku dvouzubý ostrý; 5,0 mm; 16,0 cm	Plastic hook 2 prongs sharp; 5,0 mm; 16,0 cm	33
118 31 0040	Hák resekční čtyřzubý rovný; 16,4 cm	Resection hook four-pronged straight; 16,4 cm	35
118 31 0070	Hák resekční dvouzubý rovný; 16,4 cm	Resection hook two-pronged straight; 16,4 cm	35
118 38 0010	Desmarres háček jemný; 10,0 mm; 13,0 cm	Desmarres delicate hook; 10,0 mm; 13,0 cm	32
118 38 0020	Desmarres háček jemný; 12,0 mm; 13,0 cm	Desmarres delicate hook; 12,0 mm; 13,0 cm	32
118 38 0030	Desmarres háček jemný; 14,0 mm; 13,0 cm	Desmarres delicate hook; 14,0 mm; 13,0 cm	32
118 38 0210	Háček oční dvouzubý ostrý; 2,6 mm; 13,5 cm	Eye hook two-pronged sharp; 2,6 mm; 13,5 cm	33
118 38 0220	Háček oční dvouzubý ostrý; 3,2 mm; 13,5 cm	Eye hook two-pronged sharp; 3,2 mm; 13,5 cm	33
118 38 0230	Háček oční dvouzubý ostrý; 4,0 mm; 13,5 cm	Eye hook two-pronged sharp; 4,0 mm 13,5 cm	33
118 38 0360	Háček oční čtyřzubý ostrý; 5,0 mm; 14,5 cm	Eye hook four-pronged sharp; 5,0 mm; 14,5 cm	33
118 50 0120	Hák intraorální; 22,9 cm	Intraoral hook; 22,9 cm	36
118 91 0027	Háček na rány trojzubý ostrý; 16,0 cm	Delicate hook three-pronged sharp; 16,0 cm	31
118 91 0028	Háček na rány čtyřzubý ostrý; 16,0 cm	Delicate hook four-pronged sharp; 16,0 cm	31
118 91 0035	Háček na rány trojzubý tupý; 16,0 cm	Delicate hook three-pronged blunt; 16,0 cm	31
118 91 0036	Háček na rány čtyřzubý tupý; 16,0 cm	Delicate hook four-pronged blunt; 16,0 cm	31

číslo – number	název	item	strana – page
118 91 0045	Háček na rány dvouzubý ostrý; 16,0 cm	Delicate hook two-pronged sharp; 16,0 cm	31
118 91 0046	Háček na rány trojzubý ostrý; 16,0 cm	Delicate hook three-pronged sharp; 16,0 cm	31
118 91 0047	Háček na rány čtyřzubý ostrý; 16,0 cm	Delicate hook four-pronged sharp; 16,0 cm	31
118 91 0048	Háček na rány dvouzubý tupý; 16,0 cm	Delicate hook two-pronged blunt; 16,0 cm	31
118 91 0049	Háček na rány trojzubý tupý; 16,0 cm	Delicate hook three-pronged blunt; 16,0 cm	31
118 91 0050	Háček na rány čtyřzubý tupý; 16,0 cm	Delicate hook four-pronged blunt; 16,0 cm	31
118 91 0051	Joseph háček na rány jednozubý ostrý; 16,0 cm	Joseph delicate hook one-pronged sharp; 16,0 cm	31
118 91 0052	Joseph háček na rány dvouzubý ostrý, 2,0 mm; 16,0 cm	Joseph delicate hook two-pronged sharp; 16,0 cm	31
118 91 0053	Joseph háček na rány dvouzubý ostrý, 5,0 mm; 16,0 cm	Joseph delicate hook two-pronged sharp; 16,0 cm	31
118 91 0054	Joseph háček na rány dvouzubý ostrý, 7,0 mm; 16,0 cm	Joseph delicate hook two-pronged sharp; 16,0 cm	31
118 91 0055	Joseph háček na rány dvouzubý ostrý, 10,0 mm; 16,0 cm	Joseph delicate hook two-pronged sharp; 16,0 cm	31
118 91 0069	Mini-Langenbeck háček jemný; 16,0 cm	Mini-Langenbeck delicate hook; 16,0 cm	32
118 91 0070	Mini-Langenbeck háček jemný; 16,0 cm	Mini-Langenbeck delicate hook; 16,0 cm	32
118 91 0071	Mini-Langenbeck háček jemný; 16,0 cm	Mini-Langenbeck delicate hook; 16,0 cm	32
118 91 0072	Mini-Langenbeck háček jemný; 16,0 cm	Mini-Langenbeck delicate hook; 16,0 cm	32
118 91 0077	Desmarres háček jemný; 16,0 mm; 13,0 cm	Desmarres delicate hook; 16,0 mm; 13,0 cm	32
118 91 0078	Desmarres háček jemný; 18,0 mm; 13,0 cm	Desmarres delicate hook; 18,0 mm; 13,0 cm	32
118 91 0085	Cushing háček jemný; 8,0 mm; 20,0 cm	Cushing delicate hook; 8,0 mm; 20,0 cm	32
118 91 0086	Cushing háček jemný; 10,0 mm; 20,0 cm	Cushing delicate hook; 10,0 mm; 20,0 cm	32
118 91 0087	Cushing háček jemný; 12,0 mm; 20,0 cm	Cushing delicate hook; 12,0 mm; 20,0 cm	32
118 91 0088	Cushing háček jemný; 14,0 mm; 20,0 cm	Cushing delicate hook; 14,0 mm; 20,0 cm	32
118 91 0089	Cushing háček jemný; 16,0 mm; 20,0 cm	Cushing delicate hook; 16,0 mm; 20,0 cm	32
118 91 0090	Cushing háček jemný; 18,0 mm; 20,0 cm	Cushing delicate hook; 18,0 mm; 20,0 cm	32
118 91 0091	Cushing háček jemný; 8,0 mm; 24,0 cm	Cushing delicate hook; 8,0 mm; 24,0 cm	32
118 91 0092	Cushing háček jemný; 10,0 mm; 24,0 cm	Cushing delicate hook; 10,0 mm; 24,0 cm	32
118 91 0093	Cushing háček jemný; 12,0 mm; 24,0 cm	Cushing delicate hook; 12,0 mm; 24,0 cm	32
118 91 0094	Cushing háček jemný; 14,0 mm; 24,0 cm	Cushing delicate hook; 14,0 mm; 24,0 cm	32
118 91 0095	Cushing háček jemný; 16,0 mm; 24,0 cm	Cushing delicate hook; 16,0 mm; 24,0 cm	32
118 91 0096	Cushing háček jemný; 18,0 mm; 24,0 cm	Cushing delicate hook; 18,0 mm; 24,0 cm	32
118 91 0208	Middeldorpf hák na rány okénk.; 14×17 mm; 21,5 cm	Middeldorpf retractor; 14×17 mm; 21,5 cm	34
118 91 0209	Middeldorpf hák na rány okénk.; 20×22 mm; 22,0 cm	Middeldorpf retractor; 20×22 mm; 22,0 cm	34
118 91 0210	Middeldorpf hák na rány okénk.; 26×30 mm; 23,5 cm	Middeldorpf retractor; 26×30 mm; 23,5 cm	34
118 99 0086	Hák intraorální malý; 22,9 cm	Intraoral hook; small; 22,9 cm	36
<b>119</b>	<b>Rozvěrače</b>	<b>Retractors</b>	
119 07 0010	Roser-König rozvěrač úst; 19,5 cm	Roser-König mouth retractor; 19,5 cm	37
119 07 0020	Heister rozvěrač úst; 13,0 cm	Heister mouth retractor; 13,0 cm	37
119 91 0185	Jennings rozvěrač úst; 9,0 cm	Jennings mouth retractor; 9,0 cm	37
119 91 0186	Jennings rozvěrač úst; 11,0 cm	Jennings mouth retractor; 11,0 cm	37
119 91 0187	Jennings rozvěrač úst; 13,0 cm	Jennings mouth retractor; 13,0 cm	37
119 91 0188	Jennings rozvěrač úst; 15,0 cm	Jennings mouth retractor; 15,0 cm	37
119 91 0190	Whitehead rozvěrač úst; 11,0 cm	Whitehead mouth retractor; 11,0 cm	37
119 91 0191	Whitehead rozvěrač úst; 13,0 cm	Whitehead mouth retractor; 13,0 cm	37
119 91 0192	Whitehead rozvěrač úst; 15,0 cm	Whitehead mouth retractor; 15,0 cm	37
119 91 0194	Whitehead rozvěrač úst; 11,0 cm	Whitehead mouth retractor; 11,0 cm	37
119 91 0195	Whitehead rozvěrač úst; 13,0 cm	Whitehead mouth retractor; 13,0 cm	37
119 91 0196	Whitehead rozvěrač úst; 15,0 cm	Whitehead mouth retractor; 15,0 cm	37
<b>121</b>	<b>Lopatky</b>	<b>Spatulas</b>	
121 31 0010	Buchwald lopatka na jazyk; 16×23 mm; 17,3 cm	Buchwald tongue spatula; 16×23 mm; 17,3 cm	74
121 31 0020	Brünnings lopatka na jazyk; 14×18 mm; 19,5 cm	Brünnings tongue spatula; 14×18 mm; 19,5 cm	74
121 52 0010	Lopatka na cement oboustranná; 5 mm; 18,0 cm	Cement spatula; 5 mm; 18,0 cm	95, 123
121 52 0020	Lopatka na cement oboustranná; 7,5 mm; 18,0 cm	Cement spatula; 7,5 mm; 18,0 cm	95, 123
121 52 0050	Nůž na sádru s otvíračem kvet; 18,0 cm	Plaster knife; 18,0 cm	123, 124
121 52 0060	Lopatka na sádru; 16,8 cm	Plaster spatula; 16,8 cm	123
121 52 0080	Lopatka na míchání otiskov.hmot; 21,0 cm	Mixing spatula; 21,0 cm	95, 123
<b>122</b>	<b>Zrcátka</b>	<b>Mirrors</b>	
122 51 0010	Zrcátko zubní ploché; 24 mm	Mouth mirror flat; 24 mm	75
122 51 0020	Zrcátko zubní zvětšovací; 24 mm	Mouth mirror magnifying; 24 mm	75, 76
122 51 0100	Držátko zubního zrcátka; 12,0 cm	Mirror handle; 12,0 cm	75, 76
122 51 0106	Držátko zubního zrcátka; 12,0 cm	Mirror handle; 12,0 cm	75
122 56 0106	Držátko zubního zrcátka; 13,0 cm	Dental mirror hollow handle; 13,0 cm	75
122 91 0333	Zrcátko zubní ploché HR front; vel. 5; 24 mm	Mouth mirror flat HR front; size 5; 24 mm	75
122 91 0407	Zrcátko zubní ploché HR front; vel. 4; 22 mm	Mouth mirror flat HR front; size 4; 22 mm	75
122 91 0408	Zrcátko zubní ploché HR front; vel. 0; 14 mm	Mouth mirror flat HR front; size 0; 14 mm	75
122 91 0411	Zrcátko zubní ploché HR front; vel. 8; 30 mm	Mouth mirror flat HR front; size 8; 30 mm	75
122 91 0420	Zrcátko intraorální bukalní HR front jednostranné; 16,0 cm	Intraoral mirror buccal HR front one-side coated; 16,0 cm	74
122 91 0421	Zrcátko intraorální okluzní HR front jednostranné; 15,0 cm	Intraoral mirror occlusal HR front one-side coated; 15,0 cm	74
122 91 0422	Zrcátko intraorální linguální HR front oboustranné; 16,0 cm	Intraoral mirror lingual HR front double-side coated; 16,0 cm	74
<b>123</b>	<b>Páčidla, páky</b>	<b>Elevators</b>	
123 08 0010	Langenbeck páčidlo fig. 1; 19,5 cm	Langenbeck elevator; fig. 1; 19,5 cm	20
123 08 0020	Langenbeck páčidlo fig. 2; 19,5 cm	Langenbeck elevator; fig. 2; 19,5 cm	20
123 08 0030	Williger páčidlo fig. 1; 16,0 cm	Williger elevator; fig. 1; 16,0 cm	20
123 30 0030	Freer páčidlo na nosní přepážku dvojité; 17,9 cm	Freer septum elevator; 17,9 cm	20
123 50 0010	Bein páka extrakční rovná; 3 mm; 14,5 cm	Bein root elevator straight; 3 mm; 14,5 cm	21
123 50 0011	Bein páka extrakční rovná; 3 mm; 16,5 cm	Bein root elevator straight; 3 mm; 16,5 cm	21
123 50 0020	Bein páka extrakční rovná; 4 mm; 14,5 cm	Bein root elevator straight; 4 mm; 14,5 cm	21
123 50 0021	Bein páka extrakční rovná; 4 mm; 16,5 cm	Bein root elevator straight; 4 mm; 16,5 cm	21
123 50 0050	Bein páka extrakční oblouk; 3 mm; 14,5 cm	Bein root elevator embowed; 3 mm; 14,5 cm	21

číslo – number	název	item	strana – page
123 50 0051	Bein páka extrakční oblouk.; 3 mm; 16,5 cm	Bein root elevator embowed; 3 mm; 16,5 cm	21
123 50 0060	Bein páka extrakční oblouk.; 4 mm; 14,5 cm	Bein root elevator embowed; 4 mm; 14,5 cm	21
123 50 0061	Bein páka extrakční oblouk.; 4 mm; 16,5 cm	Bein root elevator embowed; 4 mm; 16,5 cm	21
123 50 0080	Bein páka extrakční rovná jemná; 3 mm; 14,5 cm	Bein root elevator straight fine; 3 mm; 14,5 cm	22
123 50 0081	Bein páka extrakční rovná jemná; 3 mm; 16,5 cm	Bein root elevator straight fine; 3 mm; 16,5 cm	22
123 50 0090	Bein páka extrakční rovná jemná; 4 mm; 14,5 cm	Bein root elevator straight fine; 4 mm; 14,5 cm	22
123 50 0091	Bein páka extrakční rovná jemná; 4 mm; 16,5 cm	Bein root elevator straight fine; 4 mm; 16,5 cm	22
123 50 0100	Flohr páka extrakční hrotnatá pravá; 3 mm; 13,0 cm	Flohr root elevator pointed right fine; 3 mm; 13,0 cm	22
123 50 0101	Flohr páka extrakční hrotnatá pravá; 3 mm; 15,0 cm	Flohr root elevator pointed right fine; 3 mm; 15,0 cm	22
123 50 0110	Flohr páka extrakční hrotnatá levá; 3 mm; 13,0 cm	Flohr root elevator pointed left fine; 3 mm; 13,0 cm	22
123 50 0111	Flohr páka extrakční hrotnatá levá; 3 mm; 15,0 cm	Flohr root elevator pointed left fine; 3 mm; 15,0 cm	22
123 50 0130	Schlemmer páka extrakční pravá; 15,1 cm	Schlemmer root elevator right; 15,1 cm	23
123 50 0131	Schlemmer páka extrakční pravá; 17,1 cm	Schlemmer root elevator right; 17,1 cm	23
123 50 0140	Schlemmer páka extrakční levá; 15,1 cm	Schlemmer root elevator left; 15,1 cm	23
123 50 0141	Schlemmer páka extrakční levá; 17,1 cm	Schlemmer root elevator left; 17,1 cm	23
123 50 0160	Páka extrakční rovná pravá; 4 mm; 14,5 cm	Root elevator straight right; 4 mm; 14,5 cm	23
123 50 0170	Páka extrakční rovná levá; 4 mm; 14,5 cm	Root elevator straight left; 4 mm; 14,5 cm	23
123 50 0210	Špinar páka extrakční přední; 4 mm; 14,8 cm	Špinar root elevator frontal; 4 mm; 14,8 cm	24
123 50 0211	Špinar páka extrakční přední; 4 mm; 16,8 cm	Špinar root elevator frontal; 4 mm; 16,8 cm	24
123 50 0220	Špinar páka extrakční zadní; 4 mm; 14,8 cm	Špinar root elevator retral; 4 mm; 14,8 cm	24
123 50 0221	Špinar páka extrakční zadní; 4 mm; 16,8 cm	Špinar root elevator retral; 4 mm; 16,8 cm	24
123 50 0280	White páka extrakční s oblouk. ostřím vyhn.; 3 mm; 14,5 cm	Root elevator with embowed edge; 3 mm; 14,5 cm	24
123 50 0290	White páka extrakční s oblouk. ostřím vyhn.; 4 mm; 14,5 cm	Root elevator with embowed edge; 4 mm; 14,5 cm	24
123 50 0301	Barry páka extrakční pravá; 9,5 mm; 12,4 cm	Barry root elevator right; 9,5 mm; 12,4 cm	25
123 50 0311	Barry páka extrakční levá; 9,5 mm; 12,4 cm	Barry root elevator left; 9,5 mm; 12,4 cm	25
123 50 0361	Lecluse páka extrakční; 6,5 mm; 10,8 cm	Lecluse root elevator; 6,5 mm; 10,8 cm	25
123 50 0380	White páka extrakční s oblouk. ostřím vyhn.; 3 mm; 14,5 cm	Root elevator with embowed edge; 3 mm; 14,5 cm	25
123 50 0390	White páka extrakční s oblouk. ostřím vyhn.; 4 mm; 14,5 cm	Root elevator with embowed edge; 4 mm; 14,5 cm	25
123 50 0610	Nástroj na snímání korunek; 23,3 cm	Crown remover; 23,3 cm	98
123 50 0630	Páka extrakční se zuby rovná; 4 mm; 14,5 cm	Root elevator with saw edge; 4 mm; 14,5 cm	25
123 91 0006	Freer páčidlo nosní ostré; 19,0 cm	Freer nasal elevator; 19,0 cm	20
123 91 0007	Freer páčidlo nosní tupé; 19,0 cm	Freer nasal elevator; 19,0 cm	20
123 91 0008	Freer páčidlo nosní ostro-tupé; 18,0 cm	Freer nasal elevator; 18,0 cm	20
123 99 0084	Páčidlo na nosní přepážku; 3,8/4,2 mm; 17,0 cm	Septum nasal elevator; 3,8/4,2 mm; 17,0 cm	20
<b>124</b>	<b>Škrabky</b>	<b>Raspatories</b>	
124 08 0111	Williger škrabka fig. 2; 16,0 cm	Williger raspatory; fig. 2; 16,0 cm	26
124 08 0120	Langenbeck škrabka; 20,5 cm	Langenbeck raspatory; 20,5 cm	26
124 08 0130	Langenbeck škrabka; 20,4 cm	Langenbeck raspatory; 20,4 cm	26
124 08 0250	Williger škrabka 5 mm; 18,0 cm	Williger raspatory; 18,0 cm	26
124 08 0280	Williger škrabka rovná 3,5 mm; 16,0 cm	Williger raspatory; 16,0 cm	26
124 08 0290	Williger škrabka zahnutá 3,5 mm; 16,0 cm	Williger raspatory; 16,0 cm	26
124 30 0020	Přecechtěl škrabka nosní; 19,0 cm	Přecechtěl nasal raspatory; 19,0 cm	26
124 38 0160	Škrabka na operaci slzného vaku; 17,2 cm	Lachrymal sac raspatory; 17,2 cm	26
124 58 0010	Furkační kyreta; 17,2 cm	Furcation curette; 17,2 cm	105
124 58 0020	Furkační kyreta; 17,2 cm	Furcation curette; 17,2 cm	105
<b>125</b>	<b>Lžičky</b>	<b>Bone Curettes, Spoons</b>	
125 08 0110	Lžička ostrá fig. 000; 17,0 cm	Sharp spoon; fig. 000; 17,0 cm	39
125 08 0120	Lžička ostrá fig. 0; 17,2 cm	Sharp spoon; fig. 0; 17,2 cm	39
125 08 0130	Lžička ostrá fig. 1; 17,5 cm	Sharp spoon; fig. 1; 17,5 cm	39
125 08 0140	Lžička ostrá fig. 3; 17,7 cm	Sharp spoon; fig. 3; 17,7 cm	39
125 08 0150	Lžička ostrá fig. 5; 18,4 cm	Sharp spoon; fig. 5; 18,4 cm	39
125 08 0160	Lžička ostrá fig. 1; 16,5 cm	Sharp spoon; fig. 1; 16,5 cm	39
125 08 0170	Lžička ostrá fig. 2; 16,5 cm	Sharp spoon; fig. 2; 16,5 cm	39
125 08 0180	Lžička ostrá fig. 3; 17,5 cm	Sharp spoon; fig. 3; 17,5 cm	39
125 08 0190	Lžička ostrá fig. 4; 17,5 cm	Sharp spoon; fig. 4; 17,5 cm	39
125 08 0200	Lžička ostrá fig. 5; 19,5 cm	Sharp spoon; fig. 5; 19,5 cm	39
125 08 0210	Lžička ostrá fig. 6; 19,5 cm	Sharp spoon; fig. 6; 19,5 cm	39
125 50 0010	Lžička oboustranná; 17,0 cm	Bone curette double-faced; 17,0 cm	38
125 50 0050	Lžička oboustranná lomená ostrá; 2 mm; 17,0 cm	Bone curette double-faced; 2 mm; 17,0 cm	38
125 50 0060	Lžička oboustranná lomená ostrá; 3 mm; 17,0 cm	Bone curette double-faced; 3 mm; 17,0 cm	38
125 50 0070	Lžička oboustranná lomená ostrá; 4 mm; 17,0 cm	Bone curette double-faced; 4 mm; 17,0 cm	38
125 50 0090	Lžička oboustranná lomená ostrá; 6 mm; 17,0 cm	Bone curette double-faced; 6 mm; 17,0 cm	38
125 50 0100	Lžička exkochleační bajonetová pravá; 16,3 cm	Bone curette; 16,3 cm	40
125 50 0110	Lžička exkochleační bajonetová levá; 16,3 cm	Bone curette; 16,3 cm	40
125 51 0156	Lžička oboustranná ostrá; 1,5 mm; 16,6 cm	Bone curette double-faced; 1,5 mm; 16,6 cm	38
125 51 0166	Lžička oboustranná ostrá; 2,0 mm; 17,4 cm	Bone curette double-faced; 2,0 mm; 17,4 cm	38
125 51 0176	Lžička oboustranná ostrá; 2,5 mm; 16,6 cm	Bone curette double-faced; 2,5 mm; 16,6 cm	38
125 53 0010	Lžička laboratorní; 15,0 cm	Laboratory spoon; 15,0 cm	123
125 53 0020	Lžička laboratorní; 20,0 cm	Laboratory spoon; 20,0 cm	123
125 56 0066	Lžička ostrá oboustranná; 3,0 mm; 16,7 cm	Bone curette double-faced hollow handle; 3,0 mm; 16,7 cm	38
125 56 0156	Lžička ostrá oboustranná; 1,5 mm; 16,6 cm	Bone curette double-faced hollow handle; 1,5 mm; 16,6 cm	38
125 56 0166	Lžička ostrá oboustranná; 2,0 mm; 16,6 cm	Bone curette double-faced hollow handle; 2,0 mm; 16,6 cm	38
125 56 0176	Lžička ostrá oboustranná; 2,5 mm; 16,6 cm	Bone curette double-faced hollow handle; 2,5 mm; 16,6 cm	38
<b>126</b>	<b>Kyrety</b>	<b>Curettes</b>	
126 53 0010	Testovací tyčinka PMMA	Plastic test stick	105
126 58 0056	Gracey kyreta 1/2; 17,4 cm	Gracey curette 1/2; 17,4 cm	102, 104
126 58 0066	Gracey kyreta 3/4; 17,4 cm	Gracey curette 3/4; 17,4 cm	102, 104

číslo – number	název	item	strana – page
126 58 0076	Gracey kyreta 5/6; 17,3 cm	Gracey curette 5/6; 17,3 cm	102, 104
126 58 0086	Gracey kyreta 7/8; 17,0 cm	Gracey curette 7/8; 17,0 cm	102, 104
126 58 0096	Scaler oboustranný; 16,7 cm	Scaler double-faced; 16,7 cm	104, 105
126 58 0106	Gracey kyreta 11/12; 17,2 cm	Gracey curette 11/12; 17,2 cm	102, 104
126 58 0116	Gracey kyreta 13/14; 17,0 cm	Gracey curette 13/14; 17,0 cm	102, 104
126 58 0126	Gracey kyreta 15/16; 17,1 cm	Gracey curette 15/16; 17,1 cm	102, 104
126 58 0136	Gracey kyreta 17/18; 15,6 cm	Gracey curette 17/18; 15,6 cm	102, 104
126 58 0146	Gracey kyreta 9/10; 16,5 cm	Gracey curette 9/10; 16,5 cm	102, 104
126 58 1056	Mini Gracey kyreta 1/2; 17,6 cm	Mini Gracey curette 1/2; 17,6 cm	103, 104
126 58 1066	Mini Gracey kyreta 3/4; 17,4 cm	Mini Gracey curette 3/4; 17,4 cm	103, 104
126 58 1076	Mini Gracey kyreta 5/6; 17,5 cm	Mini Gracey curette 5/6; 17,5 cm	103, 104
126 58 1086	Mini Gracey kyreta 7/8; 17,1 cm	Mini Gracey curette 7/8; 17,1 cm	103, 104
126 58 1106	Mini Gracey kyreta 11/12; 17,4 cm	Mini Gracey curette 11/12; 17,4 cm	103, 104
126 58 1116	Mini Gracey kyreta 13/14; 17,4 cm	Mini Gracey curette 13/14; 17,4 cm	103, 104
126 58 1126	Mini Gracey kyreta 15/16; 17,2 cm	Mini Gracey curette 15/16; 17,2 cm	103, 104
126 58 1136	Mini Gracey kyreta 17/18; 15,8 cm	Mini Gracey curette 17/18; 15,8 cm	103, 104
126 58 1146	Mini Gracey kyreta 9/10; 16,7 cm	Mini Gracey curette 9/10; 16,7 cm	103, 104
126 91 0162	Obtahovací kamínek na ostření kyret	Sharpening stone for currettes	105
<b>127</b>	<b>Pílky, Pilníky</b>	<b>Saws, Files</b>	
127 08 0270	Pilník; 15,9 cm	Rasp; 15,9 cm	27
127 30 0100	Joseph pilník, fig. 1; 16,5 cm	Joseph rasp; fig. 1; 16,5 cm	27
127 30 0110	Joseph pilník, fig. 2; 16,5 cm	Joseph rasp; fig. 2; 16,5 cm	27
127 30 0120	Joseph pilník, fig. 3; 16,5 cm	Joseph rasp; fig. 3; 16,5 cm	27
127 30 0130	Joseph pilník, fig. 4; 16,5 cm	Joseph rasp; fig. 4; 16,5 cm	27
127 50 0001	List k pilce upínací stomatologické; 7,3 cm	Blade of stomatological saw; 7,3 cm	122
127 50 0150	Rám upínací pilky stomatologické; 19,0 cm	Frame of stomatological saw; 19,0 cm	122
127 51 1206	Pilník diamantovaný fig. 1; 2x8 mm; 15,0 cm	Diamond file; fig. 1; 2x8 mm; 15,0 cm	112
127 51 1216	Pilník diamantovaný fig. 2; 2x8 mm; 15,0 cm	Diamond file; fig. 2; 2x8 mm; 15,0 cm	112
127 51 1226	Pilník diamantovaný fig. 3; 2x8 mm; 15,2 cm	Diamond file; fig. 3; 2x8 mm; 15,2 cm	112
127 51 1236	Pilník diamantovaný fig. 4; 2x8 mm; 15,2 cm	Diamond file; fig. 4; 2x8 mm; 15,2 cm	112
127 51 1306	Pilník diamantovaný jehlový; 15,0 cm	Diamond file needle; 15,0 cm	112
127 51 1316	Pilník diamantovaný fig. 5; 2x8 mm; 15,0 cm	Diamond file; fig. 5; 2x8 mm; 15,0 cm	112
127 51 1326	Pilník diamantovaný fig. 6; 2x8 mm; 15,0 cm	Diamond file; fig. 6; 2x8 mm; 15,0 cm	112
127 51 1336	Pilník diamantovaný fig. 7; 2x8 mm; 15,0 cm	Diamond file; fig. 7; 2x8 mm; 15,0 cm	112
127 51 1346	Pilník diamantovaný fig. 8; 2x8 mm; 15,0 cm	Diamond file; fig. 8; 2x8 mm; 15,0 cm	112
<b>128</b>	<b>Dláta, Kladiva</b>	<b>Chisels, Mallets</b>	
128 08 0901	Kladívko chirurgické kovové; 250 g	Surgical mallet; 250 g	30
128 08 0911	Kladívko chirurgické kovové; 500 g	Surgical mallet; 500 g	30
128 30 0010	Dláto žlábkové; 180x2 mm	Gouge grooved; 180x2 mm	28
128 30 0030	Dláto žlábkové; 180x4 mm	Gouge grooved; 180x4 mm	28
128 30 0040	Dláto žlábkové; 180x5 mm	Gouge grooved; 180x5 mm	28
128 30 0200	West dláto žlábkové; 180x2 mm	West gouge grooved; 180x2 mm	28
128 30 0230	West dláto žlábkové; 180x5 mm	West gouge grooved; 180x5 mm	28
128 50 0050	Dláto ploché jemné; 175x3 mm	Chisel flat fine; 175x3 mm	28
128 50 0060	Dláto ploché jemné; 175x4 mm	Chisel flat fine; 175x4 mm	28
128 50 0070	Dláto ploché jemné; 175x5 mm	Chisel flat fine; 175x5 mm	28
128 50 0080	Dláto ploché jemné; 175x6 mm	Chisel flat fine; 175x6 mm	28
128 50 0110	Dláto poloklínové jemné; 175x3 mm	Chisel half-wedged fine; 175x3 mm	29
128 50 0120	Dláto poloklínové jemné; 175x4 mm	Chisel half-wedged fine; 175x4 mm	29
128 50 0130	Dláto poloklínové jemné; 175x5 mm	Chisel half-wedged fine; 175x5 mm	29
128 50 0140	Dláto poloklínové jemné; 175x6 mm	Chisel half-wedged fine; 175x6 mm	29
128 50 0200	Dláto žlábkové jemné; 175x3 mm	Chisel grooved fine; 175x3 mm	29
128 50 0210	Dláto žlábkové jemné; 175x4 mm	Chisel grooved fine; 175x4 mm	29
128 50 0220	Dláto žlábkové jemné; 175x5 mm	Chisel grooved fine; 175x5 mm	29
128 50 0230	Dláto žlábkové jemné; 175x6 mm	Chisel grooved fine; 175x6 mm	29
128 52 0110	Kladívko laboratorní ocelové; 26,0 cm	Laboratory mallet; 26,0 cm	128
128 52 0111	Kladívko laboratorní ocelové; 26,0 cm	Laboratory mallet; 26,0 cm	128
<b>129</b>	<b>Dlahy dentální</b>	<b>Dental Plates</b>	
129 51 0100	Dlaha dentální prefabrikovaná; 15,2 cm	Prefabricated plate; 15,2 cm	54
<b>132</b>	<b>Jehelce, Zavaděče</b>	<b>Needle Holders, Introducers</b>	
132 06 0200	Mathieu jehelec bez drážky; 14,0 cm	Mathieu needle holder; 14,0 cm	50
132 06 0220	Mathieu jehelec bez drážky; 17,2 cm	Mathieu needle holder; 17,2 cm	50
132 06 0300	Crile jehelec jemný; 15,0 cm	Crile needle holder fine; 15,0 cm	50
132 06 0310	Crile jehelec jemný; 15,5 cm	Crile needle holder fine; 15,5 cm	50
132 06 0341	Jehelec hloubk. rovný provlékací zámek; 16,5 cm	Needle holder; 16,5 cm	50
132 06 0370	Crile jehelec jemný diamantovaný; 1,6 mm; 15,7 cm	Crile needle holder dia; 1,6 mm; 15,7 cm	52
132 06 0450	Crile jehelec jemný provlékací zámek (vloška SK); 16,2 cm	Crile needle holder TUC; 16,2 cm	52
132 06 0500	Mathieu jehelec provl. zámek (vloška SK); 17,2 cm	Mathieu needle holder TUC; 17,2 cm	52
132 06 0510	Mathieu jehelec provl. zámek (vloška SK); 21,5 cm	Mathieu needle holder TUC; 21,5 cm	52
132 06 0520	Mathieu jehelec provl. zámek (vloška SK); 14,0 cm	Mathieu needle holder TUC; 14,0 cm	52
132 06 0600	Ryder jehelec tvrdokov; 16,5 cm	Ryder needle holder TUC; 16,5 cm	51
132 06 0610	Jehelec hloubk. rovný (vloška SK) tvrdokov; 16,5 cm	Needle holder TUC; 16,5 cm	51
132 06 0640	Ryder jehelec tvrdokov; 20,5 cm	Ryder needle holder TUC; 20,5 cm	51
132 06 0650	Ryder jehelec tvrdokov; 25,5 cm	Ryder needle holder TUC; 25,5 cm	51
132 06 0810	Jehelec s vnitřním uzávěrem vroubk.; 20,5 cm	Needle holder; 20,5 cm	50
132 38 0120	Boynton jehelec oční; 12,5 cm	Boynton eye needle holder; 12,5 cm	50
132 50 0180	Luniatschek zavaděč drenů; 17,0 cm	Luniatschek drain introducer; 17,0 cm	54

číslo – number	název	item	strana – page
<b>132 50 0186</b>	Luniatschek zavaděč drenů; 16,7 cm	Luniatschek drain introducer; 16,7 cm	54
<b>132 50 0196</b>	Luniatschek zavaděč drenů se žlábkem; 16,7 cm	Luniatschek drain introducer with groove; 16,7 cm	54
<b>132 56 0186</b>	Luniatschek zavaděč drenů; 16,8 cm	Luniatschek drain introducer hollow handle; 16,8 cm	54
<b>132 56 0196</b>	Luniatschek zavaděč drenů se žlábkem; 16,8 cm	Luniatschek drain introducer hollow handle; 16,8 cm	54
<b>132 91 0056</b>	Mathieu jehelec bez drážky; 20,0 cm	Mathieu needle holder; 20,0 cm	50
<b>132 91 0057</b>	Mathieu jehelec bez drážky; 24,0 cm	Mathieu needle holder; 24,0 cm	50
<b>132 91 0160</b>	Olsen-Hegar jehelec/nůžky tvrdokov; 14,0 cm	Olsen-Hegar needle holder/scs. TUC; 14,0 cm	51
<b>132 91 0161</b>	Olsen-Hegar jehelec/nůžky tvrdokov; 17,0 cm	Olsen-Hegar needle holder/scs. TUC; 17,0 cm	51
<b>132 91 0162</b>	Olsen-Hegar jehelec/nůžky tvrdokov; 19,0 cm	Olsen-Hegar needle holder/scs. TUC; 19,0 cm	51
<b>132 91 0168</b>	Mathieu jehelec jemný tvrdokov; 17,0 cm	Mathieu needle holder TUC; 17,0 cm	52
<b>132 91 0169</b>	Mathieu jehelec jemný tvrdokov; 20,0 cm	Mathieu needle holder TUC; 20,0 cm	52
<b>132 91 0170</b>	Mathieu jehelec jemný tvrdokov; 23,0 cm	Mathieu needle holder TUC; 23,0 cm	52
<b>132 91 0182</b>	Boynton jehelec oční tvrdokov; 12,5 cm	Boynton eye needle holder; 12,5 cm	52
<b>132 91 0215</b>	Castroviejo jehelec rovný vroubkovaný tvrdokov; 14,0 cm	Castroviejo needle holder TUC; 14,0 cm	53
<b>132 91 0216</b>	Castroviejo jehelec zahnutý vroubkovaný tvrdokov; 14,0 cm	Castroviejo needle holder TUC; 14,0 cm	53
<b>132 91 0219</b>	Castroviejo jehelec rovný vroubkovaný tvrdokov; 18,0 cm	Castroviejo micro-needle holder TUC; 18,0 cm	53
<b>132 91 0220</b>	Castroviejo jehelec zahnutý vroubkovaný tvrdokov; 18,0 cm	Castroviejo micro-needle holder TUC; 18,0 cm	53
<b>132 91 0221</b>	Jacobson jehelec mikro hladký tvrdokov; 21,0 cm	Jacobson micro-needle holder TUC; 21,0 cm	53
<b>132 91 0222</b>	Jacobson jehelec mikro vroubkovaný tvrdokov; 21,0 cm	Jacobson micro-needle holder TUC; 21,0 cm	53
<b>132 91 0257</b>	Castroviejo jehelec mikro rovný hladký; 14,0 cm	Castroviejo micro-needle holder; 14,0 cm	53
<b>132 91 0258</b>	Castroviejo jehelec mikro zahnutý hladký; 14,0 cm	Castroviejo micro-needle holder; 14,0 cm	53
<b>132 91 0259</b>	Castroviejo jehelec mikro rovný vroubkovaný; 14,0 cm	Castroviejo micro-needle holder; 14,0 cm	53
<b>132 91 0260</b>	Castroviejo jehelec mikro zahnutý vroubkovaný; 14,0 cm	Castroviejo micro-needle holder; 14,0 cm	53
<b>132 91 0261</b>	Castroviejo jehelec rovný hladký s uzávěrem; 14,0 cm	Castroviejo micro-needle holder; 14,0 cm	53
<b>132 91 0262</b>	Castroviejo jehelec zahnutý hladký s uzávěrem; 14,0 cm	Castroviejo micro-needle holder; 14,0 cm	53
<b>132 91 0263</b>	Castroviejo jehelec rovný vroubk. s uzávěrem; 14,0 cm	Castroviejo micro-needle holder; 14,0 cm	53
<b>132 91 0264</b>	Castroviejo jehelec zahnutý vroubk. s uzávěrem; 14,0 cm	Castroviejo micro-needle holder; 14,0 cm	53
<b>133</b>	<b>Sondy, pátradla</b>	<b>Probes</b>	
<b>133 50 0106</b>	Sonda parodontolog. 3,5; 5,5; 8,5; 11,5 mm; 15,2 cm	Periodontal probe; 3,5; 5,5; 8,5; 11,5 mm; 15,2 cm	101
<b>133 50 0116</b>	Sonda parodontolog. 1; 2; 3; 5; 7; 9; 11; 13 mm; 15,2 cm	Periodontal probe; 2; 3; 5; 7; 9; 11; 13 mm; 15,2 cm	101
<b>133 51 0010</b>	Pátradlo zubní háčkové krátké; 15,2 cm	Dental probe short hooked; 15,2 cm	73
<b>133 51 0016</b>	Pátradlo zubní háčkové krátké; 15,2 cm	Dental probe short hooked; 15,2 cm	73
<b>133 51 0020</b>	Pátradlo zubní háčkové dlouhé; 15,1 cm	Dental probe long hooked; 15,1 cm	73
<b>133 51 0026</b>	Pátradlo zubní háčkové dlouhé; 15,1 cm	Dental probe long hooked; 15,1 cm	73
<b>133 51 0030</b>	Pátradlo zubní obloukové; 14,5 cm	Dental probe embowed; 14,5 cm	73
<b>133 51 0036</b>	Pátradlo zubní obloukové; 14,5 cm	Dental probe embowed; 14,5 cm	73
<b>133 51 0040</b>	Pátradlo zubní vyhnuté krátké; 15,0 cm	Dental probe short angled; 15,0 cm	73
<b>133 51 0046</b>	Pátradlo zubní vyhnuté krátké; 15,0 cm	Dental probe short angled; 15,0 cm	73
<b>133 51 0050</b>	Pátradlo zubní vyhnuté dlouhé; 14,0 cm	Dental probe long angled; 14,0 cm	73, 76
<b>133 51 0056</b>	Pátradlo zubní vyhnuté dlouhé; 14,0 cm	Dental probe long angled; 14,0 cm	73
<b>133 51 0226</b>	Explorer; 15,5 cm	Explorer; 15,5 cm	101
<b>133 56 0016</b>	Pátradlo zubní háčkové krátké; 16,3 cm	Dental probe short hooked hollow handle; 16,3 cm	73
<b>133 56 0026</b>	Pátradlo zubní háčkové dlouhé; 16,2 cm	Dental probe long hooked hollow handle; 16,2 cm	73
<b>133 56 0036</b>	Pátradlo zubní obloukové; 15,6 cm	Dental probe embowed hollow handle; 15,6 cm	73
<b>133 56 0046</b>	Pátradlo zubní vyhnuté krátké; 16,1 cm	Dental probe short angled hollow handle; 16,1 cm	73
<b>133 56 0056</b>	Pátradlo zubní vyhnuté dlouhé; 15,1 cm	Dental probe long angled hollow handle; 15,1 cm	73
<b>133 58 0230</b>	Nabers furkační sonda 3-6-9-12; 17,2 cm	Nabers furcation probe 3-6-9-12; 17,2 cm	101
<b>133 58 0240</b>	Nabers furkační sonda nekalibrovaná; 17,2 cm	Nabers furcation probe non calibrated; 17,2 cm	101
<b>133 99 0177</b>	Sonda parodontologická s pátradlem; 15,7 cm	Periodontal and dental probe; 15,7 cm	101
<b>133 99 0186</b>	Pátradlo zubní obloukové, háčkové krátké; 15,7 cm	Dental probe embowed, short hooked; 15,7 cm	73
<b>136</b>	<b>Nástroje speciální</b>	<b>Special Instruments</b>	
<b>136 39 0010</b>	Toulec na pinzety; 9,0 cm	Quiver for tweezers; 9,0 cm	138
<b>136 39 0020</b>	Toulec na podávkové kleště; 20,0 cm	Quiver for forceps; 20,0 cm	138
<b>136 39 0030</b>	Toulec na pinzety; 9,0 cm	Quiver for tweezers; 9,0 cm	138
<b>136 39 0040</b>	Toulec na podávkové kleště; 20,0 cm	Quiver for forceps; 20,0 cm	138
<b>136 39 0050</b>	Toulec na pinzety s podstavcem; 11,0 cm	Tweezer quiver with stand; 11,0 cm	138
<b>136 39 0060</b>	Toulec na kleště s podstavcem; 20,0 cm	Forceps quiver with stand; 20,0 cm	138
<b>136 39 0070</b>	Toulec na pinzety s podstavcem; 9,0 cm	Tweezer quiver with stand; 9,0 cm	138
<b>136 39 0110</b>	Táček dentální; 180×120×15 mm	Dental tray; 180×120×15 mm	141
<b>136 39 0140</b>	Krabička sterilizační; nerez; 200×100×30 mm	Sterilization box; 200×100×30 mm	140
<b>136 39 0150</b>	Krabička sterilizační; nerez; 170×70×30 mm	Sterilization box; 170×70×30 mm	140
<b>136 39 0160</b>	Krabička sterilizační; nerez; 200×100×40 mm	Sterilization box; 200×100×40 mm	140
<b>136 39 0170</b>	Krabička s rovným víkem/úch.; nerez; 210×115×45 mm	Box; 210×115×45 mm	140
<b>136 39 0180</b>	Krabička s příhrádkami dvoji víčko; 210×110×25 mm	Box; 210×110×25 mm	140
<b>136 39 0190</b>	Krabička s vypouklým víčkem; 210×115×45 mm	Box; 210×115×45 mm	140
<b>136 39 0200</b>	Krabička na katetry, víčko s úch.; nerez; 300×80×40 mm	Box; 300×80×40 mm	140
<b>136 39 0210</b>	Krabička s bočními prohlubněmi; nerez; 92×40×17 mm	Box; 92×40×17 mm	141
<b>136 39 0211</b>	Krabička kulatá; nerez; 65×15 mm	Box round; 65×15 mm	139
<b>136 39 0212</b>	Krabička kulatá perforovaná; nerez; 62×13 mm	Box round perforated; 62×13 mm	139
<b>136 39 0213</b>	Krabička kulatá; nerez; 40×13 mm	Box round; 40×13 mm	139
<b>136 39 0214</b>	Krabička kulatá; nerez; 80×18 mm	Box round; 80×18 mm	139
<b>136 39 0215</b>	Krabička kulatá; nerez; 90×20 mm	Box round; 90×20 mm	139
<b>136 39 0216</b>	Krabička kulatá; nerez; 100×20 mm	Box round; 100×20 mm	139
<b>136 39 0220</b>	Krabička s poklopem a úchytem; nerez; 350×90×50 mm	Box; 350×90×50 mm	140
<b>136 39 0230</b>	Krabička s poklopem a úchytem; nerez; 230×150×60 mm	Box; 230×150×60 mm	140
<b>136 39 0240</b>	Krabička s poklopem a rov.úch.; nerez; 300×200×50 mm	Box; 300×200×50 mm	140
<b>136 39 0250</b>	Krabička s poklopem a rov. úch.; nerez; 200×150×45 mm	Box; 200×150×45 mm	140

číslo – number	název	item	strana – page
<b>136 39 0260</b>	Nádobka oválná – emitní miska; nerez; 175×100×25 mm	Bowl; 175×100×25 mm	139
<b>136 39 0270</b>	Nádobka kovová; nerez; 90×40 mm	Bowl; 90×40 mm	139
<b>136 39 0320</b>	Nádobka medicínská kovová; 82×30 mm	Bowl; 82×30 mm	139
<b>136 39 0330</b>	Tácek; nerez; 200×100×10 mm	Tray; 200×100×10 mm	141
<b>136 39 0340</b>	Tácek s drážkami; nerez; 190×100×17 mm	Tray; 200×100×10 mm	141
<b>136 39 0350</b>	Tácek hluboký; nerez; 200×100×30 mm	Tray; 200×100×30 mm	141
<b>136 39 0360</b>	Tácek; nerez; 190×100×10 mm	Tray; 190×100×10 mm	141
<b>136 39 0370</b>	Tácek; nerez; 280×190×20 mm	Tray; 280×190×20 mm	141
<b>136 39 0380</b>	Tácek; nerez; 350×250×20 mm	Tray; 350×250×20 mm	141
<b>136 39 0410</b>	Krabička na umělý chrup; 80×80×40 mm	Box for denture; 80×80×40 mm	141
<b>136 91 0001</b>	Langenbeck chránič prstu	Langenbeck finger protector	36
<b>136 91 0002</b>	Langenbeck chránič prstu	Langenbeck finger protector	36
<b>136 91 0003</b>	Langenbeck chránič prstu	Langenbeck finger protector	36
<b>136 91 0259</b>	Kontejner; 285×280×100 mm; stříbrný	Container; 285×280×100 mm; silver	144
<b>136 91 0260</b>	Kontejner; 285×280×100 mm; modrý	Container; 285×280×100 mm; blue	144
<b>136 91 0261</b>	Kontejner; 285×280×100 mm; červený	Container; 285×280×100 mm; red	144
<b>136 91 0262</b>	Kontejner; 285×280×100 mm; zelený	Container; 285×280×100 mm; green	144
<b>136 91 0263</b>	Kontejner; 285×280×100 mm; zlatý	Container; 285×280×100 mm; gold	144
<b>136 91 0264</b>	Kontejner; 285×280×100 mm; černý	Container; 285×280×100 mm; black	144
<b>136 91 0265</b>	Kontejner; 285×280×135 mm; stříbrný	Container; 285×280×135 mm; silver	144
<b>136 91 0266</b>	Kontejner; 285×280×135 mm; modrý	Container; 285×280×135 mm; blue	144
<b>136 91 0267</b>	Kontejner; 285×280×135 mm; červený	Container; 285×280×135 mm; red	144
<b>136 91 0268</b>	Kontejner; 285×280×135 mm; zelený	Container; 285×280×135 mm; green	144
<b>136 91 0269</b>	Kontejner; 285×280×135 mm; zlatý	Container; 285×280×135 mm; gold	144
<b>136 91 0270</b>	Kontejner; 285×280×135 mm; černý	Container; 285×280×135 mm; black	144
<b>136 91 0271</b>	Kontejner; 285×280×150 mm; stříbrný	Container; 285×280×150 mm; silver	144
<b>136 91 0272</b>	Kontejner; 285×280×150 mm; modrý	Container; 285×280×150 mm; blue	144
<b>136 91 0273</b>	Kontejner; 285×280×150 mm; červený	Container; 285×280×150 mm; red	144
<b>136 91 0274</b>	Kontejner; 285×280×150 mm; zelený	Container; 285×280×150 mm; green	144
<b>136 91 0275</b>	Kontejner; 285×280×150 mm; zlatý	Container; 285×280×150 mm; gold	144
<b>136 91 0276</b>	Kontejner; 285×280×150 mm; černý	Container; 285×280×150 mm; black	144
<b>136 91 0277</b>	Kontejner; 285×280×200 mm; stříbrný	Container; 285×280×200 mm; silver	144
<b>136 91 0278</b>	Kontejner; 285×280×200 mm; modrý	Container; 285×280×200 mm; blue	144
<b>136 91 0279</b>	Kontejner; 285×280×200 mm; červený	Container; 285×280×200 mm; red	144
<b>136 91 0280</b>	Kontejner; 285×280×200 mm; zelený	Container; 285×280×200 mm; green	144
<b>136 91 0281</b>	Kontejner; 285×280×200 mm; stříbrný	Container; 285×280×200 mm; gold	144
<b>136 91 0282</b>	Kontejner; 285×280×200 mm; černý	Container; 285×280×200 mm; black	144
<b>136 91 0283</b>	Kontejner; 285×280×260 mm; stříbrný	Container; 285×280×260 mm; silver	144
<b>136 91 0284</b>	Kontejner; 285×280×260 mm; modrý	Container; 285×280×260 mm; blue	144
<b>136 91 0285</b>	Kontejner; 285×280×260 mm; červený	Container; 285×280×260 mm; red	144
<b>136 91 0286</b>	Kontejner; 285×280×260 mm; zelený	Container; 285×280×260 mm; green	144
<b>136 91 0287</b>	Kontejner; 285×280×260 mm; zlatý	Container; 285×280×260 mm; gold	144
<b>136 91 0288</b>	Kontejner; 285×280×260 mm; černý	Container; 285×280×260 mm; black	144
<b>136 91 0337</b>	Kontejner; 285×280×100 mm; stříbrný	Container; 285×280×100 mm; silver	144
<b>136 91 0338</b>	Kontejner; 285×280×100 mm; modrý	Container; 285×280×100 mm; blue	144
<b>136 91 0339</b>	Kontejner; 285×280×100 mm; červený	Container; 285×280×100 mm; red	144
<b>136 91 0340</b>	Kontejner; 285×280×100 mm; zelený	Container; 285×280×100 mm; green	144
<b>136 91 0341</b>	Kontejner; 285×280×100 mm; zlatý	Container; 285×280×100 mm; gold	144
<b>136 91 0342</b>	Kontejner; 285×280×100 mm; černý	Container; 285×280×100 mm; black	144
<b>136 91 0343</b>	Kontejner; 285×280×135 mm; stříbrný	Container; 285×280×135 mm; silver	144
<b>136 91 0344</b>	Kontejner; 285×280×135 mm; modrý	Container; 285×280×135 mm; blue	144
<b>136 91 0345</b>	Kontejner; 285×280×135 mm; červený	Container; 285×280×135 mm; red	144
<b>136 91 0346</b>	Kontejner; 285×280×135 mm; zelený	Container; 285×280×135 mm; green	144
<b>136 91 0347</b>	Kontejner; 285×280×135 mm; zlatý	Container; 285×280×135 mm; gold	144
<b>136 91 0348</b>	Kontejner; 285×280×135 mm; černý	Container; 285×280×135 mm; black	144
<b>136 91 0349</b>	Kontejner; 285×280×150 mm; stříbrný	Container; 285×280×150 mm; silver	144
<b>136 91 0350</b>	Kontejner; 285×280×150 mm; modrý	Container; 285×280×150 mm; blue	144
<b>136 91 0351</b>	Kontejner; 285×280×150 mm; červený	Container; 285×280×150 mm; red	144
<b>136 91 0352</b>	Kontejner; 285×280×150 mm; zelený	Container; 285×280×150 mm; green	144
<b>136 91 0353</b>	Kontejner; 285×280×150 mm; zlatý	Container; 285×280×150 mm; gold	144
<b>136 91 0354</b>	Kontejner; 285×280×150 mm; černý	Container; 285×280×150 mm; black	144
<b>136 91 0355</b>	Kontejner; 285×280×200 mm; stříbrný	Container; 285×280×200 mm; silver	144
<b>136 91 0356</b>	Kontejner; 285×280×200 mm; modrý	Container; 285×280×200 mm; blue	144
<b>136 91 0357</b>	Kontejner; 285×280×200 mm; červený	Container; 285×280×200 mm; red	144
<b>136 91 0358</b>	Kontejner; 285×280×200 mm; zelený	Container; 285×280×200 mm; green	144
<b>136 91 0359</b>	Kontejner; 285×280×200 mm; zlatý	Container; 285×280×200 mm; gold	144
<b>136 91 0360</b>	Kontejner; 285×280×200 mm; černý	Container; 285×280×200 mm; black	144
<b>136 91 0361</b>	Kontejner; 285×280×260 mm; stříbrný	Container; 285×280×260 mm; silver	144
<b>136 91 0362</b>	Kontejner; 285×280×260 mm; modrý	Container; 285×280×260 mm; blue	144
<b>136 91 0363</b>	Kontejner; 285×280×260 mm; červený	Container; 285×280×260 mm; red	144
<b>136 91 0364</b>	Kontejner; 285×280×260 mm; zelený	Container; 285×280×260 mm; green	144
<b>136 91 0365</b>	Kontejner; 285×280×260 mm; zlatý	Container; 285×280×260 mm; gold	144
<b>136 91 0366</b>	Kontejner; 285×280×260 mm; černý	Container; 285×280×260 mm; black	144
<b>136 91 0389</b>	Podložka silikonová; 500×210 mm	Silicon mat; 500×210 mm	148
<b>136 91 0415</b>	Víko perforované; 285×280 mm; stříbrné	Lid perforated; 285×280 mm; silver	144
<b>136 91 0416</b>	Víko perforované; 285×280 mm; modré	Lid perforated; 285×280 mm; blue	144
<b>136 91 0417</b>	Víko perforované; 285×280 mm; červené	Lid perforated; 285×280 mm; red	144



číslo – number	název	item	strana – page
136 91 0418	Víko perforované; 285×280 mm; zelené	Lid perforated; 285×280 mm; green	144
136 91 0419	Víko perforované; 285×280 mm; zlaté	Lid perforated; 285×280 mm; gold	144
136 91 0420	Víko perforované; 285×280 mm; černé	Lid perforated; 285×280 mm; black	144
136 91 0438	Víko ochranné; 285×280 mm; stříbrné	Safety lid; 285×280 mm; silver	144
136 91 0439	Víko ochranné; 285×280 mm; modré	Safety lid; 285×280 mm; blue	144
136 91 0440	Víko ochranné; 285×280 mm; červené	Safety lid; 285×280 mm; red	144
136 91 0441	Víko ochranné; 285×280 mm; zelené	Safety lid; 285×280 mm; green	144
136 91 0442	Víko ochranné; 285×280 mm; zlaté	Safety lid; 285×280 mm; gold	144
136 91 0443	Víko ochranné; 285×280 mm; černé	Safety lid; 285×280 mm; black	144
136 91 0463	Vana perforovaná; 285×280×100 mm	Bottom perforated; 285×280×100 mm	144
136 91 0464	Vana perforovaná; 285×280×135 mm	Bottom perforated; 285×280×135 mm	144
136 91 0465	Vana perforovaná; 285×280×150 mm	Bottom perforated; 285×280×150 mm	144
136 91 0466	Vana perforovaná; 285×280×200 mm	Bottom perforated; 285×280×200 mm	144
136 91 0467	Vana perforovaná; 285×280×260 mm	Bottom perforated; 285×280×260 mm	144
136 91 0475	Vana neperforovaná; 285×280×100 mm	Bottom non-perforated; 285×280×100 mm	144
136 91 0476	Vana neperforovaná; 285×280×135 mm	Bottom non-perforated; 285×280×135 mm	144
136 91 0477	Vana neperforovaná; 285×280×150 mm	Bottom non-perforated; 285×280×150 mm	144
136 91 0478	Vana neperforovaná; 285×280×200 mm	Bottom non-perforated; 285×280×200 mm	144
136 91 0479	Vana neperforovaná; 285×280×260 mm	Bottom non-perforated; 285×280×260 mm	144
136 91 0485	Víko perforované; 300×140 mm; stříbrné	Lid perforated; 300×140 mm; silver	146
136 91 0486	Víko perforované; 300×140 mm; modré	Lid perforated; 300×140 mm; blue	146
136 91 0487	Víko perforované; 300×140 mm; červené	Lid perforated; 300×140 mm; red	146
136 91 0488	Víko perforované; 300×140 mm; zelené	Lid perforated; 300×140 mm; green	146
136 91 0489	Víko perforované; 300×140 mm; zlaté	Lid perforated; 300×140 mm; gold	146
136 91 0490	Víko neperforované; 285×280 mm; stříbrné	Lid non-perforated; 285×280 mm; silver	144
136 91 0491	Víko neperforované; 285×280 mm; modré	Lid non-perforated; 285×280 mm; blue	144
136 91 0492	Víko neperforované; 285×280 mm; červené	Lid non-perforated; 285×280 mm; red	144
136 91 0493	Víko neperforované; 285×280 mm; zelené	Lid non-perforated; 285×280 mm; green	144
136 91 0494	Víko neperforované; 285×280 mm; zlaté	Lid non-perforated; 285×280 mm; gold	144
136 91 0495	Víko neperforované; 285×280 mm; černé	Lid non-perforated; 285×280 mm; black	144
136 91 0513	Víko neperforované; 300×140 mm; stříbrné	Lid non-perforated; 300×140 mm; silver	146
136 91 0514	Víko neperforované; 300×140 mm; modré	Lid non-perforated; 300×140 mm; blue	146
136 91 0515	Víko neperforované; 300×140 mm; červené	Lid non-perforated; 300×140 mm; red	146
136 91 0516	Víko neperforované; 300×140 mm; zelené	Lid non-perforated; 300×140 mm; green	146
136 91 0517	Víko neperforované; 300×140 mm; zlaté	Lid non-perforated; 300×140 mm; gold	146
136 91 0526	Koš síťový; 255×245×30 mm	Wire basket; 255×245×30 mm	144
136 91 0527	Koš síťový; 255×245×50 mm	Wire basket; 255×245×50 mm	144
136 91 0528	Koš síťový; 255×245×70 mm	Wire basket; 255×245×70 mm	144
136 91 0529	Koš síťový; 255×245×100 mm	Wire basket; 255×245×100 mm	144
136 91 0534	Filtr standardní papírový; 100 ks	Paper filters standard; 100 pieces	147
136 91 0535	Filtr standardní textilní; 1 ks	Textile filter standard; 1 piece	147
136 91 0536	Filtr mini papírový; 100 ks	Paper filters small; 100 pieces	147
136 91 0537	Filtr mini textilní; 1ks	Textile filter mini; 1 piece	147
136 91 0540	Štítek identifikační papírový standardní; 100 ks	Paper label with indicator; 100 pieces	147
136 91 0541	Štítek identifikační papírový malý; 100 ks	Paper label with indicator; 100 pieces	147
136 91 0542	Zámek bezpečnostní plastový; 100 ks	Plastic security seal; 100 pieces	147
136 91 0543	Štítek identifikační; stříbrný	Identification label blank; silver	147
136 91 0544	Štítek identifikační; zlatý	Identification label blank; golden	147
136 91 0545	Štítek identifikační; červený	Identification label blank; red	147
136 91 0546	Štítek identifikační; modrý	Identification label blank; blue	147
136 91 0547	Štítek identifikační; zelený	Identification label blank; green	147
136 91 0548	Štítek identifikační; černý	Identification label blank; black	147
136 91 0550	Štítek identifikační pro text; stříbrný	Identification label engrave; silver	147
136 91 0551	Štítek identifikační pro text; zlatý	Identification label engrave; golden	147
136 91 0552	Štítek identifikační pro text; červený	Identification label engrave; red	147
136 91 0553	Štítek identifikační pro text; modrý	Identification label engrave; blue	147
136 91 0554	Štítek identifikační pro text; zelený	Identification label engrave; green	147
136 91 0555	Štítek identifikační pro text; černý	Identification label engrave; black	147
136 91 0569	Kontejner mini; 300×140×40 mm; stříbrný	Small set container; 300×140×40 mm; silver	146
136 91 0570	Kontejner mini; 300×140×40 mm; modrý	Small set container; 300×140×40 mm; blue	146
136 91 0571	Kontejner mini; 300×140×40 mm; červený	Small set container; 300×140×40 mm; red	146
136 91 0572	Kontejner mini; 300×140×40 mm; zelený	Small set container; 300×140×40 mm; green	146
136 91 0573	Kontejner mini; 300×140×40 mm; zlatý	Small set container; 300×140×40 mm; gold	146
136 91 0574	Kontejner mini; 300×140×70 mm; stříbrný	Small set container; 300×140×70 mm; silver	146
136 91 0575	Kontejner mini; 300×140×70 mm; modrý	Small set container; 300×140×70 mm; blue	146
136 91 0576	Kontejner mini; 300×140×70 mm; červený	Small set container; 300×140×70 mm; red	146
136 91 0577	Kontejner mini; 300×140×70 mm; zelený	Small set container; 300×140×70 mm; green	146
136 91 0578	Kontejner mini; 300×140×70 mm; zlatý	Small set container; 300×140×70 mm; gold	146
136 91 0579	Kontejner mini; 300×140×100 mm; stříbrný	Small set container; 300×140×100 mm; silver	146
136 91 0580	Kontejner mini; 300×140×100 mm; modrý	Small set container; 300×140×100 mm; blue	146
136 91 0581	Kontejner mini; 300×140×100 mm; červený	Small set container; 300×140×100 mm; red	146
136 91 0582	Kontejner mini; 300×140×100 mm; zelený	Small set container; 300×140×100 mm; green	146
136 91 0583	Kontejner mini; 300×140×100 mm; zlatý	Small set container; 300×140×100 mm; gold	146
136 91 0584	Kontejner mini; 300×140×40 mm; stříbrný	Small set container; 300×140×40 mm; silver	146
136 91 0585	Kontejner mini; 300×140×40 mm; modrý	Small set container; 300×140×40 mm; blue	146
136 91 0586	Kontejner mini; 300×140×40 mm; červený	Small set container; 300×140×40 mm; red	146
136 91 0587	Kontejner mini; 300×140×40 mm; zelený	Small set container; 300×140×40 mm; green	146

číslo – number	název	item	strana – page
136 91 0588	Kontejner mini; 300×140×40 mm; zlatý	Small set container; 300×140×40 mm; gold	146
136 91 0589	Kontejner mini; 300×140×70 mm; stříbrný	Small set container; 300×140×70 mm; silver	146
136 91 0590	Kontejner mini; 300×140×70 mm; modrý	Small set container; 300×140×70 mm; blue	146
136 91 0591	Kontejner mini; 300×140×70 mm; červený	Small set container; 300×140×70 mm; red	146
136 91 0592	Kontejner mini; 300×140×70 mm; zelený	Small set container; 300×140×70 mm; green	146
136 91 0593	Kontejner mini; 300×140×70 mm; zlatý	Small set container; 300×140×70 mm; gold	146
136 91 0594	Kontejner mini; 300×140×100 mm; stříbrný	Small set container; 300×140×100 mm; silver	146
136 91 0595	Kontejner mini; 300×140×100 mm; modrý	Small set container; 300×140×100 mm; blue	146
136 91 0596	Kontejner mini; 300×140×100 mm; červený	Small set container; 300×140×100 mm; red	146
136 91 0597	Kontejner mini; 300×140×100 mm; zelený	Small set container; 300×140×100 mm; green	146
136 91 0598	Kontejner mini; 300×140×100 mm; zlatý	Small set container; 300×140×100 mm; gold	146
136 91 0599	Vana perforovaná; 300×140×40 mm	Bottom perforated; 300×140×40 mm	146
136 91 0600	Vana perforovaná; 300×140×70 mm	Bottom perforated; 300×140×70 mm	146
136 91 0601	Vana perforovaná; 300×140×100 mm	Bottom perforated; 300×140×100 mm	146
136 91 0602	Vana neperforovaná; 300×140×40 mm	Bottom non-perforated; 300×140×40 mm	146
136 91 0603	Vana neperforovaná; 300×140×70 mm	Bottom non-perforated; 300×140×70 mm	146
136 91 0604	Vana neperforovaná; 300×140×100 mm	Bottom non-perforated; 300×140×100 mm	146
136 91 0619	Rouška textilní zelená; 60×40 cm	Cloth green; 60×40 cm	148
136 91 0620	Rouška textilní zelená; 85×85 cm	Cloth green; 85×85 cm	148
136 91 0621	Rouška textilní zelená; 100×140 cm	Cloth green; 100×140 cm	148
136 91 0622	Rouška textilní zelená; 275×125 cm	Cloth green; 275×125 cm	148
136 91 0623	Rouška textilní zelená; 245×245 cm	Cloth green; 245×245 cm	148
136 91 0624	Podložka silikonová; 275×125 mm	Silicon mat; 275×125 mm	148
136 91 0625	Podložka silikonová; 225×225 mm	Silicon mat; 225×225 mm	148
136 91 0626	Podložka silikonová; 300×300 mm	Silicon mat; 300×300 mm	148
136 91 0630	Podložka silikonová; 440×230 mm	Silicon mat; 440×230 mm	148
136 91 0635	Filtr teflonový standardní; 1 ks	Teflon filter standard; 1 piece	147
136 91 0645	Víko perforované; 310×190 mm; stříbrné	Lid perforated; 310×190 mm; silver	145
136 91 0646	Víko perforované; 310×190 mm; modré	Lid perforated; 310×190 mm; blue	145
136 91 0647	Víko perforované; 310×190 mm; červené	Lid perforated; 310×190 mm; red	145
136 91 0648	Víko perforované; 310×190 mm; zelené	Lid perforated; 310×190 mm; green	145
136 91 0649	Víko perforované; 310×190 mm; zlaté	Lid perforated; 310×190 mm; gold	145
136 91 0650	Víko perforované; 310×190 mm; černé	Lid perforated; 310×190 mm; black	145
136 91 0652	Víko perforované; 300×140 mm; černé	Lid perforated; 300×140 mm; black	146
136 91 0653	Víko neperforované; 310×190 mm; stříbrné	Lid non perforated; 310×190 mm; silver	145
136 91 0654	Víko neperforované; 310×190 mm; modré	Lid non perforated; 310×190 mm; blue	145
136 91 0655	Víko neperforované; 310×190 mm; červené	Lid non perforated; 310×190 mm; red	145
136 91 0656	Víko neperforované; 310×190 mm; zelené	Lid non perforated; 310×190 mm; green	145
136 91 0657	Víko neperforované; 310×190 mm; zlaté	Lid non perforated; 310×190 mm; gold	145
136 91 0658	Víko neperforované; 310×190 mm; černé	Lid non perforated; 310×190 mm; black	145
136 91 0659	Víko neperforované; 300×140 mm; černé	Lid non perforated; 300×140 mm; black	146
136 91 0660	Vložka síťová; 270×125 mm	Wire base; 270×125 mm	146
136 91 0661	Koš síťový; 267×125×50 mm	Wire basket; 267×125×50 mm	146
136 91 0662	Koš síťový; 274×172×43 mm	Wire basket; 274×172×43 mm	145
136 91 0667	Rám napínací jednoduchý 255×255 mm	Drape retainer single 255×255 mm	144
136 91 0668	Rám napínací 255×255 mm	Drape retainer double 255×255 mm	144
136 91 0669	Rám napínací dentální; 270×170 mm	Drape retainer dental; 270×170 mm	145
136 91 0670	Rám napínací malý; 270×125 mm	Drape retainer small; 270×125 mm	146
136 91 0675	Síto oddělovací; 255×245×130 mm	Divider; 255×245×130 mm	144
136 91 0676	Filtr dentální papírový; 100 ks	Filter; paper; 100 pieces; dental	147
136 91 0677	Filtr dentální textilní; 1 ks	Filter; textile; 1 piece; dental	147
136 91 0684	Kontejner mini; 300×140×40mm; černý	Small set container; 300×140×40mm; black	146
136 91 0685	Kontejner mini; 300×140×70mm; černý	Small set container; 300×140×70mm; black	146
136 91 0686	Kontejner mini; 300×140×100mm; černý	Small set container; 300×140×100mm; black	146
136 91 0687	Kontejner mini; 300×140×40mm; černý	Small set container; 300×140×40mm; black	146
136 91 0688	Kontejner mini; 300×140×70mm; černý	Small set container; 300×140×70mm; black	146
136 91 0689	Kontejner mini; 300×140×100mm; černý	Small set container; 300×140×100mm; black	146
136 91 0690	Vana perforovaná; 310×190×40 mm	Bottom perforated; 310×190×40 mm	145
136 91 0691	Vana perforovaná; 310×190×65 mm	Bottom perforated; 310×190×65 mm	145
136 91 0692	Vana perforovaná; 310×190×130 mm	Bottom perforated; 310×190×130 mm	145
136 91 0693	Vana neperforovaná; 310×190×40 mm	Bottom non perforated; 310×190×40 mm	145
136 91 0694	Vana neperforovaná; 310×190×65 mm	Bottom non perforated; 310×190×65 mm	145
136 91 0695	Vana neperforovaná; 310×190×130 mm	Bottom non perforated; 310×190×130 mm	145
136 91 0696	Kontejner dentální; 310×190×40 mm; stříbrný	Dental container; 310×190×40 mm; silver	145
136 91 0697	Kontejner dentální; 310×190×40 mm; modrý	Dental container; 310×190×40 mm; blue	145
136 91 0698	Kontejner dentální; 310×190×40 mm; červený	Dental container; 310×190×40 mm; red	145
136 91 0699	Kontejner dentální; 310×190×40 mm; zelený	Dental container; 310×190×40 mm; green	145
136 91 0700	Kontejner dentální; 310×190×40 mm; zlatý	Dental container; 310×190×40 mm; gold	145
136 91 0701	Kontejner dentální; 310×190×40 mm; černý	Dental container; 310×190×40 mm; black	145
136 91 0702	Kontejner dentální; 310×190×65 mm; stříbrný	Dental container; 310×190×65 mm; silver	145
136 91 0703	Kontejner dentální; 310×190×65 mm; modrý	Dental container; 310×190×65 mm; blue	145
136 91 0704	Kontejner dentální; 310×190×65 mm; červený	Dental container; 310×190×65 mm; red	145
136 91 0705	Kontejner dentální; 310×190×65 mm; zelený	Dental container; 310×190×65 mm; green	145
136 91 0706	Kontejner dentální; 310×190×65 mm; zlatý	Dental container; 310×190×65 mm; gold	145
136 91 0707	Kontejner dentální; 310×190×65 mm; černý	Dental container; 310×190×65 mm; black	145
136 91 0708	Kontejner dentální; 310×190×130 mm; stříbrný	Dental container; 310×190×130 mm; silver	145
136 91 0709	Kontejner dentální; 310×190×130 mm; modrý	Dental container; 310×190×130 mm; blue	145

číslo – number	název	item	strana – page
136 91 0710	Kontejner dentální; 310×190×130 mm; červený	Dental container; 310×190×130 mm; red	145
136 91 0711	Kontejner dentální; 310×190×130 mm; zelený	Dental container; 310×190×130 mm; green	145
136 91 0712	Kontejner dentální; 310×190×130 mm; zlatý	Dental container; 310×190×130 mm; gold	145
136 91 0713	Kontejner dentální; 310×190×130 mm; černý	Dental container; 310×190×130 mm; black	145
136 91 0714	Kontejner dentální; 310×190×40 mm; stříbrný	Dental container; 310×190×40 mm; silver	145
136 91 0715	Kontejner dentální; 310×190×40 mm; modrý	Dental container; 310×190×40 mm; blue	145
136 91 0716	Kontejner dentální; 310×190×40 mm; červený	Dental container; 310×190×40 mm; red	145
136 91 0717	Kontejner dentální; 310×190×40 mm; zelený	Dental container; 310×190×40 mm; green	145
136 91 0718	Kontejner dentální; 310×190×40 mm; zlatý	Dental container; 310×190×40 mm; gold	145
136 91 0719	Kontejner dentální; 310×190×40 mm; černý	Dental container; 310×190×40 mm; black	145
136 91 0720	Kontejner dentální; 310×190×65 mm; stříbrný	Dental container; 310×190×65 mm; silver	145
136 91 0721	Kontejner dentální; 310×190×65 mm; modrý	Dental container; 310×190×65 mm; blue	145
136 91 0722	Kontejner dentální; 310×190×65 mm; červený	Dental container; 310×190×65 mm; red	145
136 91 0723	Kontejner dentální; 310×190×65 mm; zelený	Dental container; 310×190×65 mm; green	145
136 91 0724	Kontejner dentální; 310×190×65 mm; zlatý	Dental container; 310×190×65 mm; gold	145
136 91 0725	Kontejner dentální; 310×190×65 mm; černý	Dental container; 310×190×65 mm; black	145
136 91 0726	Kontejner dentální; 310×190×130 mm; stříbrný	Dental container; 310×190×130 mm; silver	145
136 91 0727	Kontejner dentální; 310×190×130 mm; modrý	Dental container; 310×190×130 mm; blue	145
136 91 0728	Kontejner dentální; 310×190×130 mm; červený	Dental container; 310×190×130 mm; red	145
136 91 0729	Kontejner dentální; 310×190×130 mm; zelený	Dental container; 310×190×130 mm; green	145
136 91 0730	Kontejner dentální; 310×190×130 mm; zlatý	Dental container; 310×190×130 mm; gold	145
136 91 0731	Kontejner dentální; 310×190×130 mm; černý	Dental container; 310×190×130 mm; black	145
136 91 1275	Buben sterilizační; 125×80 mm	Sterilization drum; 125×80 mm	143
136 91 1276	Buben sterilizační; 125×100 mm	Sterilization drum; 125×100 mm	143
136 91 1277	Buben sterilizační; 125×125 mm	Sterilization drum; 125×125 mm	143
136 91 1278	Buben sterilizační; 150×100 mm	Sterilization drum; 150×100 mm	143
136 91 1279	Buben sterilizační; 150×130 mm	Sterilization drum; 150×130 mm	143
136 91 1280	Buben sterilizační; 150×150 mm	Sterilization drum; 150×150 mm	143
136 91 1281	Buben sterilizační; 150×190 mm	Sterilization drum; 150×190 mm	143
136 91 1282	Buben sterilizační; 150×240 mm	Sterilization drum; 150×240 mm	143
136 91 1283	Buben sterilizační; 190×95 mm	Sterilization drum; 190×95 mm	143
136 91 1284	Buben sterilizační; 190×125 mm	Sterilization drum; 190×125 mm	143
136 91 1285	Buben sterilizační; 190×145 mm	Sterilization drum; 190×145 mm	143
136 91 1286	Buben sterilizační; 190×165 mm	Sterilization drum; 190×165 mm	143
136 91 1287	Buben sterilizační; 190×190 mm	Sterilization drum; 190×190 mm	143
136 91 1288	Buben sterilizační; 190×240 mm	Sterilization drum; 190×240 mm	143
136 91 1289	Buben sterilizační; 190×290 mm	Sterilization drum; 190×290 mm	143
136 91 1290	Buben sterilizační; 240×120 mm	Sterilization drum; 240×120 mm	143
136 91 1291	Buben sterilizační; 240×165 mm	Sterilization drum; 240×165 mm	143
136 91 1292	Buben sterilizační; 240×190 mm	Sterilization drum; 240×190 mm	143
136 91 1293	Buben sterilizační; 240×240 mm	Sterilization drum; 240×240 mm	143
136 91 1294	Buben sterilizační; 240×290 mm	Sterilization drum; 240×290 mm	143
136 91 1295	Buben sterilizační; 290×120 mm	Sterilization drum; 290×120 mm	143
136 91 1296	Buben sterilizační; 290×145 mm	Sterilization drum; 290×145 mm	143
136 91 1297	Buben sterilizační; 290×165 mm	Sterilization drum; 290×165 mm	143
136 91 1298	Buben sterilizační; 290×190 mm	Sterilization drum; 290×190 mm	143
136 91 1299	Buben sterilizační; 290×240 mm	Sterilization drum; 290×240 mm	143
136 91 1300	Buben sterilizační; 290×290 mm	Sterilization drum; 290×290 mm	143
136 91 1301	Buben sterilizační; 340×120 mm	Sterilization drum; 340×120 mm	143
136 91 1302	Buben sterilizační; 340×145 mm	Sterilization drum; 340×145 mm	143
136 91 1303	Buben sterilizační; 340×165 mm	Sterilization drum; 340×165 mm	143
136 91 1304	Buben sterilizační; 340×190 mm	Sterilization drum; 340×190 mm	143
136 91 1305	Buben sterilizační; 340×240 mm	Sterilization drum; 340×240 mm	143
136 91 1306	Buben sterilizační; 340×290 mm	Sterilization drum; 340×290 mm	143
136 91 1307	Buben sterilizační; 390×140 mm	Sterilization drum; 390×140 mm	143
136 91 1308	Buben sterilizační; 390×165 mm	Sterilization drum; 390×165 mm	143
136 91 1309	Buben sterilizační; 390×190 mm	Sterilization drum; 390×190 mm	143
136 91 1310	Buben sterilizační; 390×240 mm	Sterilization drum; 390×240 mm	143
136 91 1311	Buben sterilizační; 390×290 mm	Sterilization drum; 390×290 mm	143
136 91 1312	Buben sterilizační; 390×340 mm	Sterilization drum; 390×340 mm	143
136 91 1313	Buben sterilizační; 390×390 mm	Sterilization drum; 390×390 mm	143
136 91 1314	Buben sterilizační; 125×80 mm	Sterilization drum; 125×80 mm	142
136 91 1315	Buben sterilizační; 125×100 mm	Sterilization drum; 125×100 mm	142
136 91 1316	Buben sterilizační; 125×125 mm	Sterilization drum; 125×125 mm	142
136 91 1317	Buben sterilizační; 150×80 mm	Sterilization drum; 150×80 mm	142
136 91 1318	Buben sterilizační; 150×100 mm	Sterilization drum; 150×100 mm	142
136 91 1319	Buben sterilizační; 150×130 mm	Sterilization drum; 150×130 mm	142
136 91 1320	Buben sterilizační; 150×150 mm	Sterilization drum; 150×150 mm	142
136 91 1321	Buben sterilizační; 150×190 mm	Sterilization drum; 150×190 mm	142
136 91 1322	Buben sterilizační; 150×240 mm	Sterilization drum; 150×240 mm	142
136 91 1323	Buben sterilizační; 190×95 mm	Sterilization drum; 190×95 mm	142
136 91 1324	Buben sterilizační; 190×125 mm	Sterilization drum; 190×125 mm	142
136 91 1325	Buben sterilizační; 190×145 mm	Sterilization drum; 190×145 mm	142
136 91 1326	Buben sterilizační; 190×165 mm	Sterilization drum; 190×165 mm	142
136 91 1327	Buben sterilizační; 190×190 mm	Sterilization drum; 190×190 mm	142
136 91 1328	Buben sterilizační; 190×240 mm	Sterilization drum; 190×240 mm	142
136 91 1329	Buben sterilizační; 190×290 mm	Sterilization drum; 190×290 mm	142

číslo – number	název	item	strana – page
<b>136 91 1330</b>	Buben sterilizační; 240×95 mm	Sterilization drum; 240×95 mm	142
<b>136 91 1331</b>	Buben sterilizační; 240×120 mm	Sterilization drum; 240×120 mm	142
<b>136 91 1332</b>	Buben sterilizační; 240×145 mm	Sterilization drum; 240×145 mm	142
<b>136 91 1333</b>	Buben sterilizační; 240×165 mm	Sterilization drum; 240×165 mm	142
<b>136 91 1334</b>	Buben sterilizační; 240×190 mm	Sterilization drum; 240×190 mm	142
<b>136 91 1335</b>	Buben sterilizační; 240×240 mm	Sterilization drum; 240×240 mm	142
<b>136 91 1336</b>	Buben sterilizační; 240×290 mm	Sterilization drum; 240×290 mm	142
<b>136 91 1337</b>	Buben sterilizační; 240×340 mm	Sterilization drum; 240×340 mm	142
<b>136 91 1338</b>	Buben sterilizační; 240×390 mm	Sterilization drum; 240×390 mm	142
<b>136 91 1339</b>	Buben sterilizační; 290×120 mm	Sterilization drum; 290×120 mm	142
<b>136 91 1340</b>	Buben sterilizační; 290×145 mm	Sterilization drum; 290×145 mm	142
<b>136 91 1341</b>	Buben sterilizační; 290×165 mm	Sterilization drum; 290×165 mm	142
<b>136 91 1342</b>	Buben sterilizační; 290×190 mm	Sterilization drum; 290×190 mm	142
<b>136 91 1343</b>	Buben sterilizační; 290×240 mm	Sterilization drum; 290×240 mm	142
<b>136 91 1344</b>	Buben sterilizační; 290×290 mm	Sterilization drum; 290×290 mm	142
<b>136 91 1345</b>	Buben sterilizační; 290×340 mm	Sterilization drum; 290×340 mm	142
<b>136 91 1346</b>	Buben sterilizační; 290×390 mm	Sterilization drum; 290×390 mm	142
<b>136 91 1347</b>	Buben sterilizační; 340×120 mm	Sterilization drum; 340×120 mm	142
<b>136 91 1348</b>	Buben sterilizační; 340×145 mm	Sterilization drum; 340×145 mm	142
<b>136 91 1349</b>	Buben sterilizační; 340×165 mm	Sterilization drum; 340×165 mm	142
<b>136 91 1350</b>	Buben sterilizační; 340×190 mm	Sterilization drum; 340×190 mm	142
<b>136 91 1351</b>	Buben sterilizační; 340×240 mm	Sterilization drum; 340×240 mm	142
<b>136 91 1352</b>	Buben sterilizační; 340×290 mm	Sterilization drum; 340×290 mm	142
<b>136 91 1353</b>	Buben sterilizační; 340×340 mm	Sterilization drum; 340×340 mm	142
<b>136 91 1354</b>	Buben sterilizační; 340×390 mm	Sterilization drum; 340×390 mm	142
<b>136 91 1355</b>	Buben sterilizační; 390×140 mm	Sterilization drum; 390×140 mm	142
<b>136 91 1356</b>	Buben sterilizační; 390×165 mm	Sterilization drum; 390×165 mm	142
<b>136 91 1357</b>	Buben sterilizační; 390×190 mm	Sterilization drum; 390×190 mm	142
<b>136 91 1358</b>	Buben sterilizační; 390×240 mm	Sterilization drum; 390×240 mm	142
<b>136 91 1359</b>	Buben sterilizační; 390×290 mm	Sterilization drum; 390×290 mm	142
<b>136 91 1360</b>	Buben sterilizační; 390×340 mm	Sterilization drum; 390×340 mm	142
<b>136 91 1361</b>	Buben sterilizační; 390×390 mm	Sterilization drum; 390×390 mm	142
<b>136 91 1362</b>	Buben sterilizační; 390×490 mm	Sterilization drum; 390×490 mm	142
<b>136 91 1363</b>	Buben sterilizační; 390×590 mm	Sterilization drum; 390×590 mm	142
<b>136 91 1364</b>	Buben sterilizační; 480×165 mm	Sterilization drum; 480×165 mm	142
<b>136 91 1365</b>	Buben sterilizační; 480×190 mm	Sterilization drum; 480×190 mm	142
<b>136 91 1366</b>	Buben sterilizační; 480×240 mm	Sterilization drum; 480×240 mm	142
<b>136 91 1367</b>	Buben sterilizační; 480×290 mm	Sterilization drum; 480×290 mm	142
<b>136 91 1368</b>	Buben sterilizační; 480×340 mm	Sterilization drum; 480×340 mm	142
<b>136 91 1369</b>	Buben sterilizační; 480×390 mm	Sterilization drum; 480×390 mm	142
<b>139</b>	<b>Stomatologické soubory</b>	<b>Stomatological Sets</b>	
<b>139 50 0120</b>	Soubor základních stomatologických nástrojů malý	Set of basic stomatological instruments small	76
<b>139 50 0150</b>	Držák	Holder	76, 139
<b>139 50 0160</b>	Kazeta s držákem	Cassette with holder	139
<b>139 50 0170</b>	Kazeta pro stomatologické nástroje	Cassette	76, 139
<b>139 50 0360</b>	Soubor pro zubní techniky	Set for dental technicians	124
<b>139 50 0770</b>	Soubor parodontologických nástrojů, set 1	Set of periodontal instruments, set 1	104
<b>139 50 0780</b>	Soubor parodontologických nástrojů, set 2	Set of periodontal instruments, set 2	104
<b>139 50 0810</b>	Soubor parodontologických nástrojů Mini, set 1	Set of mini periodontal instruments, set 1	104
<b>147</b>	<b>Nástroje na zubní kámen</b>	<b>Scalers</b>	
<b>147 51 0010</b>	Nástroj na zubní kámen; 15,5 cm	Scaler; 15,5 cm	106
<b>147 51 0016</b>	Nástroj na zubní kámen; 15,5 cm	Scaler; 15,5 cm	106
<b>147 51 0018</b>	Nástroj na zubní kámen; 15,5 cm TiN	Scaler TiN; 15,5 cm	106
<b>147 51 0020</b>	Drápek na zubní kámen; 15,5 cm	Scaler; 15,5 cm	106
<b>147 51 0026</b>	Drápek na zubní kámen; 15,5 cm	Scaler; 15,5 cm	106
<b>147 51 0028</b>	Drápek na zubní kámen; 15,5 cm TiN	Scaler TiN; 15,5 cm	106
<b>147 51 0030</b>	Srpek na zubní kámen; 0,6 mm; 15,5 cm	Scaler; 0,6 mm; 15,5 cm	106
<b>147 51 0036</b>	Srpek na zubní kámen; 0,6 mm; 15,5 cm	Scaler; 0,6 mm; 15,5 cm	106
<b>147 51 0038</b>	Srpek na zubní kámen; 0,6 mm; 15,5 cm TiN	Scaler TiN; 0,6 mm; 15,5 cm	106
<b>147 51 0040</b>	Srpek na zubní kámen; 0,9 mm; 15,5 cm	Scaler; 0,9 mm; 15,5 cm	76, 106
<b>147 51 0046</b>	Srpek na zubní kámen; 0,9 mm; 15,5 cm	Scaler; 0,9 mm; 15,5 cm	106
<b>147 51 0048</b>	Srpek na zubní kámen; 0,9 mm; 15,5 cm TiN	Scaler TiN; 0,9 mm; 15,5 cm	106
<b>147 51 0060</b>	Srpek na zubní kámen 2xlomený; 15,5, cm	Scaler double angled; 15,5, cm	107
<b>147 51 0066</b>	Srpek na zubní kámen 2xlomený; 15,5, cm	Scaler double angled; 15,5, cm	107
<b>147 51 0068</b>	Srpek na zubní kámen 2xlomený; 15,5, cm TiN	Scaler double angled TiN; 15,5, cm	107
<b>147 51 0070</b>	Škrabka na zubní kámen pravá; 2 mm; 15,5 cm	Scaler right; 2 mm; 15,5 cm	107
<b>147 51 0076</b>	Škrabka na zubní kámen pravá; 2 mm; 15,5 cm	Scaler right; 2 mm; 15,5 cm	108
<b>147 51 0078</b>	Škrabka na zubní kámen pravá; 2 mm; 15,5 cm TiN	Scaler right TiN; 2 mm; 15,5 cm	107
<b>147 51 0080</b>	Škrabka na zubní kámen pravá; 3 mm; 15,5 cm	Scaler right; 3 mm; 15,5 cm	107
<b>147 51 0086</b>	Škrabka na zubní kámen pravá; 3 mm; 15,5 cm	Scaler right; 3 mm; 15,5 cm	108
<b>147 51 0088</b>	Škrabka na zubní kámen pravá; 3 mm; 15,5 cm TiN	Scaler right TiN; 3 mm; 15,5 cm	107
<b>147 51 0100</b>	Škrabka na zubní kámen levá; 2 mm; 15,5 cm	Scaler left; 2 mm; 15,5 cm	107
<b>147 51 0106</b>	Škrabka na zubní kámen levá; 2 mm; 15,5 cm	Scaler left; 2 mm; 15,5 cm	108
<b>147 51 0108</b>	Škrabka na zubní kámen levá; 2 mm; 15,5 cm TiN	Scaler left TiN; 2 mm; 15,5 cm	107
<b>147 51 0110</b>	Škrabka na zubní kámen levá; 3 mm; 15,5 cm	Scaler left; 3 mm; 15,5 cm	107
<b>147 51 0116</b>	Škrabka na zubní kámen levá; 3 mm; 15,5 cm	Scaler left; 3 mm; 15,5 cm	108
<b>147 51 0118</b>	Škrabka na zubní kámen levá; 3 mm; 15,5 cm TiN	Scaler left TiN; 3 mm; 15,5 cm	107

číslo – number	název	item	strana – page
147 51 0130	Black dlátka na sklovinu pravé; 9x2 mm; 15,5 cm	Black scaler right; 9x2 mm; 15,5 cm	111
147 51 0136	Black dlátka na sklovinu pravé; 9x2 mm; 15,5 cm	Black scaler right; 9x2 mm; 15,5 cm	111
147 51 0138	Black dlátka na sklovinu pravé; 9x2 mm; 15,5 cm TiN	Black scaler right TiN; 9x2 mm; 15,5 cm	111
147 51 0150	Black dlátka na sklovinu levé; 9x2 mm; 15,5 cm	Black scaler left; 9x2 mm; 15,5 cm	111
147 51 0156	Black dlátka na sklovinu levé; 9x2 mm; 15,5 cm	Black scaler left; 9x2 mm; 15,5 cm	111
147 51 0158	Black dlátka na sklovinu levé; 9x2 mm; 15,5 cm TiN	Black scaler left TiN; 9x2 mm; 15,5 cm	111
147 51 0170	Black dlátka na sklovinu pravé; 8x1,5 mm; 15,5 cm	Black scaler right; 8x1,5 mm; 15,5 cm	111
147 51 0176	Black dlátka na sklovinu pravé; 8x1,5 mm; 15,5 cm	Black scaler right; 8x1,5 mm; 15,5 cm	111
147 51 0178	Black dlátka na sklovinu pravé; 8x1,5 mm; 15,5 cm TiN	Black scaler right TiN; 8x1,5 mm; 15,5 cm	111
147 51 0180	Black dlátka na sklovinu levé; 8x1,5 mm; 15,5 cm	Black scaler left; 8x1,5 mm; 15,5 cm	111
147 51 0186	Black dlátka na sklovinu levé; 8x1,5 mm; 15,5 cm	Black scaler left; 8x1,5 mm; 15,5 cm	111
147 51 0188	Black dlátka na sklovinu levé; 8x1,5 mm; 15,5 cm TiN	Black scaler left TiN; 8x1,5 mm; 15,5 cm	111
147 51 0200	Nástroj na zubní kámen pravý; 1,5 mm; 15,5 cm	Cutting instrument right; 1,5 mm; 15,5 cm	109
147 51 0206	Nástroj na zubní kámen pravý; 1,5 mm; 15,5 cm	Cutting instrument right; 1,5 mm; 15,5 cm	109
147 51 0208	Nástroj na zubní kámen pravý; 1,5 mm; 15,5 cm TiN	Cutting instrument right TiN; 1,5 mm; 15,5 cm	109
147 51 0210	Nástroj na zubní kámen pravý; 2,0 mm; 15,5 cm	Cutting instrument right; 2,0 mm; 15,5 cm	109
147 51 0216	Nástroj na zubní kámen pravý; 2,0 mm; 15,5 cm	Cutting instrument right; 2,0 mm; 15,5 cm	109
147 51 0218	Nástroj na zubní kámen pravý; 2,0 mm; 15,5 cm TiN	Cutting instrument right TiN; 2,0 mm; 15,5 cm	109
147 51 0220	Nástroj na zubní kámen pravý; 2,5 mm; 15,5 cm	Cutting instrument right; 2,5 mm; 15,5 cm	109
147 51 0226	Nástroj na zubní kámen pravý; 2,5 mm; 15,5 cm	Cutting instrument right; 2,5 mm; 15,5 cm	109
147 51 0228	Nástroj na zubní kámen pravý; 2,5 mm; 15,5 cm TiN	Cutting instrument right TiN; 2,5 mm; 15,5 cm	109
147 51 0250	Nástroj na zubní kámen levý; 1,5 mm; 15,5 cm	Cutting instrument left; 1,5 mm; 15,5 cm	109
147 51 0256	Nástroj na zubní kámen levý; 1,5 mm; 15,5 cm	Cutting instrument left; 1,5 mm; 15,5 cm	109
147 51 0258	Nástroj na zubní kámen levý; 1,5 mm; 15,5 cm TiN	Cutting instrument left TiN; 1,5 mm; 15,5 cm	109
147 51 0260	Nástroj na zubní kámen levý; 2,0 mm; 15,5 cm	Cutting instrument left; 2,0 mm; 15,5 cm	109
147 51 0266	Nástroj na zubní kámen levý; 2,0 mm; 15,5 cm	Cutting instrument left; 2,0 mm; 15,5 cm	109
147 51 0268	Nástroj na zubní kámen levý; 2,0 mm; 15,5 cm TiN	Cutting instrument left TiN; 2,0 mm; 15,5 cm	109
147 51 0270	Nástroj na zubní kámen levý; 2,5 mm; 15,5 cm	Cutting instrument left; 2,5 mm; 15,5 cm	109
147 51 0276	Nástroj na zubní kámen levý; 2,5 mm; 15,5 cm	Cutting instrument left; 2,5 mm; 15,5 cm	109
147 51 0278	Nástroj na zubní kámen levý; 2,5 mm; 15,5 cm TiN	Cutting instrument left TiN; 2,5 mm; 15,5 cm	109
147 51 0300	Black dlátka na sklovinu; 9x1,5 mm; 15,5 cm	Black enamel chisel; 9x1,5 mm; 15,5 cm	110
147 51 0306	Black dlátka na sklovinu; 9x1,5 mm; 15,5 cm	Black enamel chisel; 9x1,5 mm; 15,5 cm	110
147 51 0308	Black dlátka na sklovinu; 9x1,5 mm; 15,5 cm TiN	Black enamel chisel TiN; 9x1,5 mm; 15,5 cm	110
147 51 0310	Black dlátka na sklovinu; 9x2,0 mm; 15,5 cm	Black enamel chisel; 9x2,0 mm; 15,5 cm	110
147 51 0316	Black dlátka na sklovinu; 9x2,0 mm; 15,5 cm	Black enamel chisel; 9x2,0 mm; 15,5 cm	110
147 51 0318	Black dlátka na sklovinu; 9x2,0 mm; 15,5 cm TiN	Black enamel chisel TiN; 9x2,0 mm; 15,5 cm	110
147 51 0320	Black dlátka na sklovinu; 9x3,0 mm; 15,5 cm	Black enamel chisel; 9x3,0 mm; 15,5 cm	110
147 51 0326	Black dlátka na sklovinu; 9x3,0 mm; 15,5 cm	Black enamel chisel; 9x3,0 mm; 15,5 cm	110
147 51 0328	Black dlátka na sklovinu; 9x3,0 mm; 15,5 cm TiN	Black enamel chisel TiN; 9x3,0 mm; 15,5 cm	110
147 51 0336	Black škrabka na zubní kámen levá; 1,0 mm; 15,5 cm	Black scaler left; 1,0 mm; 15,5 cm	108
147 51 0346	Black škrabka na zubní kámen pravá; 1,0 mm; 15,5 cm	Black scaler right; 1,0 mm; 15,5 cm	108
147 51 0350	Black dlátka na sklovinu zahnuté; 8x1,5 mm; 15,5 cm	Black enamel chisel curved; 8x1,5 mm; 15,5 cm	110
147 51 0356	Black dlátka na sklovinu zahnuté; 8x1,5 mm; 15,5 cm	Black enamel chisel curved; 8x1,5 mm; 15,5 cm	110
147 51 0358	Black dlátka na sklovinu zahnuté; 8x1,5 mm; 15,5 cm TiN	Black enamel chisel curved TiN; 8x1,5 mm; 15,5 cm	110
147 51 0360	Black dlátka na sklovinu zahnuté; 9x2 mm; 15,5 cm	Black enamel chisel curved; 9x2 mm; 15,5 cm	110
147 51 0366	Black dlátka na sklovinu zahnuté; 9x2 mm; 15,5 cm	Black enamel chisel curved; 9x2 mm; 15,5 cm	110
147 51 0368	Black dlátka na sklovinu zahnuté; 9x2 mm; 15,5 cm TiN	Black enamel chisel curved TiN; 9x2 mm; 15,5 cm	110
147 51 0376	Black dlátka na sklovinu levé; 8x1 mm; 15,5 cm	Black enamel chisel left; 8x1 mm; 15,5 cm	111
147 51 0386	Black dlátka na sklovinu pravé; 8x1 mm; 15,5 cm	Black enamel chisel right; 8x1 mm; 15,5 cm	111
147 51 0806	Zešíkmořič gingiválních okrajů distální; 16,6 cm	Gingival margin trimmer distal; 16,6 cm	108
147 51 0816	Zešíkmořič gingiválních okrajů meziální; 16,6 cm	Gingival margin trimmer mesial; 16,6 cm	108
<b>148</b>	<b>Exkavátory</b>	<b>Excavators</b>	
148 51 0010	Exkavátor jednostranný rovný; 2,0 mm; 15,5 cm	Excavator straight; 2,0 mm; 15,5 cm	79
148 51 0016	Exkavátor jednostranný rovný; 2,0 mm; 15,5 cm	Excavator straight; 2,0 mm; 15,5 cm	79
148 51 0026	Exkavátor jednostranný rovný; 2,5 mm; 15,5 cm	Excavator straight; 2,5 mm; 15,5 cm	79
148 51 0056	Exkavátor jednostr.zahnutý pravý; 1,5 mm; 15,5 cm	Excavator curved right; 1,5 mm; 15,5 cm	79
148 51 0076	Exkavátor jednostr.zahnutý levý; 1,5 mm; 15,5 cm	Excavator curved left; 1,5 mm; 15,5 cm	79
148 51 0096	Exkavátor oboustranný; 0,8/1,0 mm; 16,8 cm	Excavator double-faced; 0,8/1,0 mm; 16,8 cm	80
148 51 0100	Exkavátor oboustranný; 1,5 mm; 17,0 cm	Excavator double-faced; 1,5 mm; 17,0 cm	80
148 51 0106	Exkavátor oboustranný; 1,5 mm; 16,8 cm	Excavator double-faced; 1,5 mm; 16,8 cm	80
148 51 0110	Exkavátor oboustranný; 2,0 mm; 17,0 cm	Excavator double-faced; 2,0 mm; 17,0 cm	76, 80
148 51 0116	Exkavátor oboustranný; 2,0 mm; 16,8 cm	Excavator double-faced; 2,0 mm; 16,8 cm	80
148 51 0120	Exkavátor oboustranný; 2,5 mm; 17,0 cm	Excavator double-faced; 2,5 mm; 17,0 cm	80
148 51 0126	Exkavátor oboustranný; 2,5 mm; 16,8 cm	Excavator double-faced; 2,5 mm; 16,8 cm	80
148 51 0136	Exkavátor oboustranný; 1,0 mm; 16,8 cm	Excavator double-faced; 1,0 mm; 16,8 cm	80
<b>151</b>	<b>Nástroje pro výplně</b>	<b>Filling Instruments</b>	
151 51 0010	Nosič amalgamu lopatkový; 3,0 mm; 15,5 cm	Plastic filling instrument – carrier; 3,0 mm; 15,5 cm	81
151 51 0016	Nosič amalgamu lopatkový; 3,0 mm; 15,5 cm	Plastic filling instrument – carrier; 3,0 mm; 15,5 cm	81
151 51 0056	Nosič amalgamu lžičkový; 1,2/3 mm; 16,7 cm	Plastic filling instrument – carrier; 1,2/3 mm; 16,7 cm	81
151 51 0060	Nosič amalgamu s kříž. řezem; 1,2/3 mm; 17,0 cm	Plastic filling instrument – carrier; 1,2/3 mm; 17,0 cm	81
151 51 0066	Nosič amalgamu s kříž. řezem; 1,2/3 mm; 16,7 cm	Plastic filling instrument – carrier; 1,2/3 mm; 16,7 cm	81
151 51 0080	Cpátko amalgamu oboustranné; 2/3 mm; 17,0 cm	Plastic filling instrument – plugger; 2/3 mm; 17,0 cm	82
151 51 0086	Cpátko amalgamu oboustranné; 2/3 mm; 16,5 cm	Plastic filling instrument – plugger; 2/3 mm; 16,5 cm	82
151 51 0096	Cpátko amalgamu oboustranné; 2/3 mm; 16,5 cm	Plastic filling instrument – plugger; 2/3 mm; 16,5 cm	82
151 51 0097	Cpátko kompoz.mater.oboustr.; 2/3 mm; 17,0 cm TiN	Plastic filling instrument – plugger TiN; 2/3 mm; 17,0 cm	82
151 51 0126	Hladítko se cpátkem fig. 1; 16,6 cm	Plastic filling instrument – spatula-plugger fig. 1; 16,6 cm	86
151 51 0127	Hladítko se cpátkem fig. 1; 16,6 cm TiN	Plastic filling instrument – spatula-plugger fig. 1 TiN; 16,6 cm	86

číslo – number	název	item	strana – page
151 51 0130	Hladítko se cpátkem fig. 1; 17,0 cm	Plastic filling instrument – spatula-plugger fig. 1; 17,0 cm	86
151 51 0136	Hladítko se cpátkem fig. 1; 16,6 cm	Plastic filling instrument – spatula-plugger fig. 1; 16,6 cm	86
151 51 0140	Hladítko se cpátkem fig. 2; 17,0 cm	Plastic filling instrument – spatula-plugger fig. 2; 17,0 cm	86
151 51 0146	Hladítko se cpátkem fig. 2; 16,6 cm	Plastic filling instrument – spatula-plugger fig. 2; 16,6 cm	86
151 51 0160	Cpátka jednostr.kořenové lomené; 0,8 mm; 16,0 cm	Plastic filling instrument – plugger; 0,8 mm; 16,0 cm	84
151 51 0166	Cpátka jednostr.kořenové lomené; 0,8 mm; 15,8 cm	Plastic filling instrument – plugger; 0,8 mm; 15,8 cm	84
151 51 0170	Cpátka jednostr.kořenové lomené; 1,2 mm; 16,0 cm	Plastic filling instrument – plugger; 1,2 mm; 16,0 cm	84
151 51 0176	Cpátka jednostr.kořenové lomené; 1,2 mm; 15,8 cm	Plastic filling instrument – plugger; 1,2 mm; 15,8 cm	84
151 51 0177	Cpátka jednostr.kořenové lomené; 1,2 mm; 17,0 cm TiN	Plastic filling instrument – plugger TiN; 1,2 mm; 17,0 cm	84
151 51 0186	Cpátka oboustranné; 0,6/0,8 mm; 16,7 cm	Plastic filling instrument – plugger; 0,6/0,8 mm; 16,7 cm	84
151 51 0187	Cpátka oboustranné; 0,6/0,8 mm; 17,0 cm TiN	Plastic filling instrument – plugger TiN; 0,6/0,8 mm; 17,0 cm	84
151 51 0190	Cpátka oboustranné; 1,2/1,6 mm; 17,0 cm	Plastic filling instrument – plugger; 1,2/1,6 mm; 17,0 cm	84
151 51 0196	Cpátka oboustranné; 1,2/1,6 mm; 16,8 cm	Plastic filling instrument – plugger; 1,2/1,6 mm; 16,8 cm	84
151 51 0197	Cpátka oboustranné; 1,2/1,6 mm; 17,0 cm TiN	Plastic filling instrument – plugger TiN; 1,2/1,6 mm; 17,0 cm	84
151 51 0200	Cpátka oboustranné; 2,0/2,5 mm; 17,0 cm	Plastic filling instrument – plugger; 2,0/2,5 mm; 17,0 cm	84
151 51 0206	Cpátka oboustranné; 2,0/2,5 mm; 16,8 cm	Plastic filling instrument – plugger; 2,0/2,5 mm; 16,8 cm	84
151 51 0207	Cpátka oboustranné; 2,0/2,5 mm; 17,0 cm TiN	Plastic filling instrument – plugger TiN; 2,0/2,5 mm; 17,0 cm	84
151 51 0246	Hladítko se cpátkem fig. 2; 16,6 cm	Plastic filling instrument – spatula-plugger fig. 2; 16,6 cm	86
151 51 0247	Hladítko se cpátkem fig. 2; 16,6 cm TiN	Plastic filling instrument – spatula-plugger TiN; 16,6 cm	86
151 51 0280	Cpátka jednostranné; 1,0/1,8 mm; 17,0 cm	Plastic filling instrument – plugger; 1,0/1,8 mm; 17,0 cm	83
151 51 0286	Cpátka oboustranné; 1,0/1,8 mm; 16,6 cm	Plastic filling instrument – plugger; 1,0/1,8 mm; 16,6 cm	83
151 51 0287	Cpátka oboustranné; 1,0/1,8 mm; 17,0 cm TiN	Plastic filling instrument – plugger TiN; 1,0/1,8 mm; 17,0 cm	83
151 51 0290	Cpátka oboustranné; 1,4/2,0 mm; 17,0 cm	Plastic filling instrument – plugger; 1,4/2,0 mm; 17,0 cm	83
151 51 0296	Cpátka oboustranné; 1,4/2,0 mm; 16,6 cm	Plastic filling instrument – plugger; 1,4/2,0 mm; 16,6 cm	83
151 51 0297	Cpátka oboustranné; 1,4/2,0 mm; 17,0 cm TiN	Plastic filling instrument – plugger TiN; 1,4/2,0 mm; 17,0 cm	83
151 51 0306	Cpátka oboustranné; 0,6/0,8 mm; 16,6 cm	Plastic filling instrument – plugger; 0,6/0,8 mm; 16,6 cm	83
151 51 0310	Cpátka kopytkové oboustranné; 17,0 cm	Plastic filling instrument – plugger; 17,0 cm	83
151 51 0316	Cpátka kopytkové oboustranné; 16,6 cm	Plastic filling instrument – plugger; 16,6 cm	83
151 51 0317	Cpátka kopytkové oboustranné; 17,0 cm TiN	Plastic filling instrument – plugger TiN; 17,0 cm	83
151 51 0320	Cpátka oboustranné; 17,0 cm	Plastic filling instrument – plugger; 17,0 cm	82
151 51 0326	Cpátka oboustranné; 16,6 cm	Plastic filling instrument – plugger; 16,6 cm	82
151 51 0340	Hladítko se cpátkem fig. 3; 17,0 cm	Plastic filling instrument – spatula-plugger fig. 3; 17,0 cm	86
151 51 0346	Hladítko se cpátkem fig. 3; 16,6 cm	Plastic filling instrument – spatula-plugger fig. 3; 16,6 cm	86
151 51 0347	Hladítko se cpátkem fig. 3; 16,6 cm TiN	Plastic filling instrument – spatula-plugger fig. 3 TiN; 16,6 cm	86
151 51 0356	Hladítko se cpátkem; 1,0/1,5 mm; 16,4 cm	Plastic filling instrument – spatula-plugger; 1,0/1,5 mm; 16,4 cm	86
151 51 0416	Nosič amalgamu; 1,4/2,0 mm; 16,6 cm	Plastic filling instrument – carrier; 1,4/2,0 mm; 16,6 cm	81
151 51 0426	Nosič amalgamu; 2,5/3,0 mm; 17,0 cm	Plastic filling instrument – carrier; 2,5/3,0 mm; 17,0 cm	81
151 51 0466	Cpátka vlákna do sulku; 2 mm; 16,6 cm	Fibre filling instrument; 2 mm; 16,6 cm	85
151 51 0506	Cpátka vlákna do sulku; 15,4 cm	Fibre filling instrument; 15,4 cm	85
151 51 0516	Zavaděč retrakčních vláken; 16,8 cm	Retentive fibre instrument; 16,8 cm	85
151 51 0526	Zavaděč retrakčních vláken; 16,8 cm	Retentive fibre instrument; 16,8 cm	85
151 51 0570	Hladítko pružné; 2,5 mm; 15,5 cm	Plastic filling instrument; 2,5 mm; 15,5 cm	88
151 51 0576	Hladítko pružné; 2,5 mm; 15,3 cm	Plastic filling instrument; 2,5 mm; 15,3 cm	88
151 51 0577	Hladítko pružné; 2,5 mm; 15,5 cm TiN	Plastic filling instrument TiN; 2,5 mm; 15,5 cm	88
151 51 0590	Nástroj na plast.výplně kapkovitý fig. 1; 15,5 cm	Plastic filling instrument fig. 1; 15,5 cm	92
151 51 0596	Nástroj na plast.výplně kapkovitý fig. 1; 15,3 cm	Plastic filling instrument fig. 1; 15,3 cm	92
151 51 0597	Nástroj na plast.výplně kapk. fig. 1; 15,5 cm TiN	Plastic filling instrument fig. 1 TiN; 15,5 cm	92
151 51 0600	Nástroj na plast.výplně kapkovitý fig. 2; 15,5 cm	Plastic filling instrument – spatula fig. 2; 15,5 cm	92
151 51 0606	Nástroj na plast.výplně kapkovitý fig. 2; 15,3 cm	Plastic filling instrument – spatula fig. 2; 15,3 cm	92
151 51 0607	Nástroj na plast.výplně kapk. fig. 2; 15,5 cm TiN	Plastic filling instrument – spatula fig. 2 TiN; 15,5 cm	92
151 51 0616	Nástroj na plast. výplně; 16,6 cm	Instrument for malleable fillings; 16,6 cm	92
151 51 0620	Hladítko oboustranné fig. 1; 17,0 cm	Plastic filling instrument – spatula fig. 1; 17,0 cm	89
151 51 0626	Hladítko oboustranné fig. 1; 16,6 cm	Plastic filling instrument – spatula fig. 1; 16,6 cm	89
151 51 0627	Hladítko oboustranné fig. 1; 16,6 cm TiN	Plastic filling instrument – spatula fig. 1 TiN; 16,6 cm	89
151 51 0630	Hladítko oboustranné fig. 2; 17,0 cm	Plastic filling instrument – spatula fig. 2; 17,0 cm	89
151 51 0636	Hladítko oboustranné fig. 2; 16,6 cm	Plastic filling instrument – spatula fig. 2; 16,6 cm	89
151 51 0637	Hladítko oboustranné fig. 2; 16,6 cm TiN	Plastic filling instrument – spatula fig. 2 TiN; 16,6 cm	89
151 51 0650	Hladítko oboustranné 3x lomené; 17,0 cm	Plastic filling instrument – spatula; 17,0 cm	88
151 51 0656	Hladítko oboustranné 3x lomené; 16,6 cm	Plastic filling instrument – spatula; 16,6 cm	88
151 51 0657	Hladítko oboustranné 3x lomené; 17,0 cm TiN	Plastic filling instrument – spatula TiN; 17,0 cm	88
151 51 0690	Hladítko oboustranné; 1,5 mm; 17,0 cm	Spatula – filling instrument; 1,5 mm; 17,0 cm	89
151 51 0696	Hladítko oboustranné; 1,5 mm; 16,6 cm	Spatula – filling instrument; 1,5 mm; 16,6 cm	89
151 51 0706	Heidemann hladítko oboustranné fig. 1; 16,6 cm	Heidemann spatula fig. 1; 16,6 cm	89
151 51 0716	Heidemann hladítko oboustranné fig. 2; 16,9 cm	Heidemann spatula fig. 2; 16,9 cm	89
151 51 0726	Heidemann hladítko oboustranné fig. 2; 17,3 cm	Heidemann spatula fig. 2; 17,3 cm	89
151 51 0760	Pistole na amalgam s kovovým pístem	Amalgam gun – metal piston	94
151 51 0770	Pistole na amalgam s kovovým pístem	Amalgam gun – metal piston	94
151 51 0780	Pistole na amalgam plastová	Amalgam gun plastic	94
151 51 0806	Nástroj na modelování výplní; 1,6 mm; 16,4 cm	Modelling instrument; 1,6 mm; 16,4 cm	90
151 51 0836	Nástroj na modelování výplní; 2,5 mm; 16,4 cm	Modelling instrument; 2,5 mm; 16,4 cm	90
151 51 0846	Nástroj na modelování výplní; 2,5 mm; 16,4 cm	Modelling instrument; 2,5 mm; 16,4 cm	90
151 51 0856	Sapin nástroj na modelování výplní; 1,6 mm; 16,0 cm	Sapin modelling instrument; 1,6 mm; 16,0 cm	90
151 51 0866	Frahm nástroj na modelování výplní; 5,0 mm; 16,6 cm	Frahm modelling instrument; 5,0 mm; 16,6 cm	90
151 51 0876	Nástroj na modelování výplní; 1,4 mm; 16,6 cm	Modelling instrument; 1,4 mm; 16,6 cm	90
151 51 0886	Nástroj na modelování výplní; 1,6/2,5 mm; 16,4 cm	Modelling instrument; 1,6/2,5 mm; 16,4 cm	91
151 51 0887	Nástroj na modelov.výplní; 1,6/2,5 mm; 17,0 cm TiN	Modelling instrument TiN; 1,6/2,5 mm; 17,0 cm	91
151 51 0896	Nástroj na modelování výplní; 2,2 mm; 16,8 cm	Modelling instrument; 2,2 mm; 16,8 cm	92

číslo – number	název	item	strana – page
151 51 0910	Nástroj na výplně ostrý; 16,4 cm	Modelling instrument; 16,4 cm	90
151 51 0916	Nástroj na výplně ostrý; 16,6 cm	Modelling instrument; 16,6 cm	90
151 51 0930	Discoid-Cleoid nástroj na výplně; 2,0/2,2 mm; 16,8 cm	Discoid-Cleoid filling instrument; 2,0/2,2 mm; 16,8 cm	92
151 51 0936	Discoid-Cleoid nástroj na výplně; 2,0/2,2 mm; 16,8 cm	Discoid-Cleoid filling instrument; 2,0/2,2 mm; 16,8 cm	92
151 51 0940	Nástroj na výplně; 2,5/3,0 mm; 16,6 cm	Plastic filling instrument – plugger; 2,5/3,0 mm; 16,6 cm	91
151 51 0946	Nástroj na výplně; 2,5/3,0 mm; 16,6 cm	Plastic filling instrument – plugger; 2,5/3,0 mm; 16,6 cm	91
151 51 0970	Svorka na separační pásky 40° zahnutá; 3,3 cm	Strip clamp; 3,3 cm	93
151 51 0980	Svorka na separační pásky 90° zahnutá; 2,5 cm	Strip clamp; 2,5 cm	93
151 51 1010	Pásek separační hladký; 120x6 mm	Separative strip smooth; 120x6 mm	93
151 51 1020	Pásek separační hladký; 120x8 mm	Separative strip smooth; 120x8 mm	93
151 51 1496	Wiland nástroj na výplně oboustranný; 16,6 cm	Wiland amalgam carver double-faced; 16,6 cm	90
151 51 2020	Pásek separační diamant. 120x3 mm; D40	Separative strip diamond 120x3 mm; D40	93
151 51 2021	Pásek separační diamant. 120x3 mm; D64	Separative strip diamond 120x3 mm; D64	93
151 51 2022	Pásek separační diamant. 120x3 mm; D107	Separative strip diamond 120x3 mm; D107	93
151 51 2030	Pásek separační diamant. 120x4 mm; D40	Separative strip diamond 120x4 mm; D40	93
151 51 2031	Pásek separační diamant. 120x4 mm; D64	Separative strip diamond 120x4 mm; D64	93
151 51 2032	Pásek separační diamant. 120x4 mm; D107	Separative strip diamond 120x4 mm; D107	93
151 51 2040	Pásek separační diamant. 120x6 mm; D40	Separative strip diamond 120x6 mm; D40	93
151 51 2041	Pásek separační diamant. 120x6 mm; D64	Separative strip diamond 120x6 mm; D64	93
151 51 2042	Pásek separační diamant. 120x6 mm; D107	Separative strip diamond 120x6 mm; D107	93
151 51 2050	Pásek separační diamant. 120x8 mm; D40	Separative strip diamond 120x8 mm; D40	93
151 51 2051	Pásek separační diamant. 120x8 mm; D64	Separative strip diamond 120x8 mm; D64	93
151 51 2052	Pásek separační diamant. 120x8 mm; D107	Separative strip diamond 120x8 mm; D107	93
151 51 3006	Cpátko oboustran.kombinované; 0,8/1,0 mm; 16,6 cm	Plastic filling instrument – plugger; 0,8/1,0 mm; 16,6 cm	83
151 51 3016	Cpátko oboustran.kombinované; 1,2/1,4 mm; 16,6 cm	Plastic filling instrument – plugger; 1,2/1,4 mm; 16,6 cm	83
151 51 3026	Cpátko oboustran.kombinované; 1,6/2,0 mm; 16,6 cm	Plastic filling instrument – plugger; 1,6/2,0 mm; 16,6 cm	83
151 51 3050	Cpátko kuličkové s hladítkem; 1,2/1,5 mm; 16,6 cm	Plastic filling instrument – spatula-plugger; 1,2/1,5 mm; 16,6 cm	87
151 51 3056	Cpátko kuličkové s hladítkem; 1,2/1,5 mm; 16,6 cm	Plastic filling instrument – spatula-plugger; 1,2/1,5 mm; 16,6 cm	87
151 51 3070	Cpátko kuličkové s hladítkem; 2,0/2,5 mm; 16,8 cm	Plastic filling instrument – spatula-plugger; 2,0/2,5 mm; 16,8 cm	87
151 51 3076	Cpátko kuličkové s hladítkem; 2,0/2,5 mm; 16,8 cm	Plastic filling instrument – spatula-plugger; 2,0/2,5 mm; 16,8 cm	87
151 51 3080	Cpátko kuličkové s hladítkem; 2,5/3,0 mm; 17,0 cm	Plastic filling instrument – spatula-plugger; 2,5/3,0 mm; 17,0 cm	87
151 51 3090	Cpátko kuličkové s hladítkem; 3,0/3,0 mm; 17,0 cm	Plastic filling instrument – spatula-plugger; 3,0/3,0 mm; 17,0 cm	87
151 51 3116	Cpátko oboustranné oválné; 2,0x1,0 mm; 16,4 cm	Plastic filling instrument – plugger; 2,0x1,0 mm; 16,4 cm	82
151 51 3126	Cpátko oboustranné oválné; 3,0x1,5 mm; 16,5 cm	Plastic filling instrument – plugger; 3,0x1,5 mm; 16,5 cm	82
151 51 3140	Cpátko oboustranné oválné; 2,0x1,0 mm; 16,5 cm	Plastic filling instrument – plugger; 2,0x1,0 mm; 16,5 cm	82
151 51 3146	Cpátko oboustranné oválné; 2,0x1,0 mm; 16,4 cm	Plastic filling instrument – plugger; 2,0x1,0 mm; 16,4 cm	82
151 51 3150	Cpátko oboustranné oválné; 3,0x1,5 mm; 16,5 cm	Plastic filling instrument – plugger; 3,0x1,5 mm; 16,5 cm	82
151 51 3156	Cpátko oboustranné oválné; 3,0x1,5 mm; 16,5 cm	Plastic filling instrument – plugger; 3,0x1,5 mm; 16,5 cm	82
151 51 3180	Planátor; 1,4/1,7 mm; 16,1 cm	Amalgam condenser; 1,4/1,7 mm; 16,1 cm	91
151 51 3186	Planátor; 1,4/1,7 mm; 16,1 cm	Amalgam condenser; 1,4/1,7 mm; 16,1 cm	91
151 51 3190	Planátor; 1,9/2,3 mm; 16,6 cm	Amalgam condenser; 1,9/2,3 mm; 16,6 cm	91
151 51 3196	Planátor; 1,9/2,3 mm; 16,6 cm	Amalgam condenser; 1,9/2,3 mm; 16,6 cm	91
151 51 3210	Nástroj pro výplně; 1,4 mm; 16,6 cm	Filling instrument; 1,4 mm; 16,6 cm	90
151 51 3220	Nástroj pro výplně; 2,0 mm; 16,6 cm	Filling instrument; 2,0 mm; 16,6 cm	90
151 51 3250	Cpátko kuličkové s hladítkem; 1,2/1,5 mm; 16,4 cm	Plastic filling instrument – spatula-plugger; 1,2/1,5 mm; 16,4 cm	87
151 51 3256	Cpátko kuličkové s hladítkem; 1,2/1,5 mm; 16,4 cm	Plastic filling instrument – spatula-plugger; 1,2/1,5 mm; 16,4 cm	87
151 51 3260	Cpátko kuličkové s hladítkem; 1,6/2,0 mm; 16,4 cm	Plastic filling instrument – spatula-plugger; 1,6/2,0 mm; 16,4 cm	87
151 51 3266	Cpátko kuličkové s hladítkem; 1,6/2,0 mm; 16,4 cm	Plastic filling instrument – spatula-plugger; 1,6/2,0 mm; 16,4 cm	87
151 51 3270	Cpátko kuličkové s hladítkem; 2,0/2,5 mm; 16,6 cm	Plastic filling instrument – spatula-plugger; 2,0/2,5 mm; 16,6 cm	87
151 51 3280	Cpátko kuličkové s hladítkem; 2,5/3,0 mm; 16,8 cm	Plastic filling instrument – spatula-plugger; 2,5/3,0 mm; 16,8 cm	87
151 51 3286	Cpátko kuličkové s hladítkem; 2,5/3,0 mm; 16,8 cm	Plastic filling instrument – spatula-plugger; 2,5/3,0 mm; 16,8 cm	87
151 51 3290	Cpátko kuličkové s hladítkem; 3,0/3,0 mm; 16,8 cm	Plastic filling instrument – spatula-plugger; 3,0/3,0 mm; 16,8 cm	87
151 51 3570	Hladítko pružné jemné; 15,5 cm	Plastic filling instrument – spatula flexible; 15,5 cm	88
151 51 3576	Hladítko pružné jemné; 15,3 cm	Plastic filling instrument – spatula flexible; 15,3 cm	88
151 51 3577	Hladítko pružné jemné; 15,5 cm TiN	Plastic filling instrument TiN – spatula flexible; 15,5 cm	88
151 51 3620	Hladítko oboustranné jemné fig. 1; 17,0 cm	Plastic filling instrument – spatula fig. 1; 17,0 cm	89
151 51 3626	Hladítko oboustranné jemné fig. 1; 16,6 cm	Plastic filling instrument – spatula fig. 1; 16,6 cm	89
151 51 3627	Hladítko oboustranné jemné fig. 1; 16,6 cm TiN	Plastic filling instrument TiN – spatula fig. 1; 16,6 cm	89
151 51 3630	Hladítko oboustranné jemné fig. 2; 17,0 cm	Plastic filling instrument – spatula fig. 2; 17,0 cm	89
151 51 3636	Hladítko oboustranné jemné fig. 2; 16,6 cm	Plastic filling instrument – spatula fig. 2; 16,6 cm	89
151 51 3637	Hladítko oboustranné jemné fig. 2; 16,6 cm TiN	Plastic filling instrument TiN – spatula fig. 2; 16,6 cm	89
151 51 3650	Hladítko oboustranné jemné 3x lomené; 17,0 cm	Plastic filling instrument – spatula; 17,0 cm	88
151 51 3656	Hladítko oboustranné jemné 3x lomené; 16,6 cm	Plastic filling instrument – spatula; 16,6 cm	88
151 51 3657	Hladítko oboustranné jemné 3x lomené; 16,6 cm TiN	Plastic filling instrument TiN – spatula; 16,6 cm	88
151 56 0056	Nosič amalgamu lžičkový; 1,2/3 mm; 16,7 cm	Carrier hollow handle; 1,2/3 mm; 16,7 cm	81
151 56 0066	Nosič amalgamu s kříž. řezem; 1,2/3 mm; 16,7 cm	Carrier hollow handle; 1,2/3 mm; 16,7 cm	81
151 56 0086	Cpátko amalgamu oboustranné; 2/3 mm; 16,5 cm	Filling instrument – angled hollow handle; 2/3 mm; 16,5 cm	82
151 56 0096	Cpátko amalgamu oboustranné; 2/3 mm; 16,5 cm	Filling instrument – angled hollow handle; 2/3 mm; 16,5 cm	82
151 56 0097	Cpátko komp.mat.oboustr.; 2-3 mm; 16,6 cm TiN	Filling instrument – angled hollow handle TiN; 2/3 mm; 16,6 cm	82
151 56 0126	Hladítko se cpátkem fig. 1; 16,6 cm	Spatula – filling instrument hollow handle; 16,6 cm	86
151 56 0127	Hladítko se cpátkem fig. 1; 16,6 cm TiN	Spatula – filling instrument – hollow handle TiN; 16,6 cm	86
151 56 0136	Hladítko se cpátkem fig. 1; 16,6 cm	Spatula – filling instrument hollow handle; 16,6 cm	86
151 56 0146	Hladítko se cpátkem fig. 2; 17,0 cm	Spatula – filling instrument hollow handle; 17,0 cm	86
151 56 0186	Cpátko oboustranné; 0,6/0,8 mm; 16,7 cm	Filling instrument – angled hollow handle; 0,6/0,8 mm; 16,7 cm	84
151 56 0187	Cpátko oboustranné; 0,6/0,8 mm; 16,7 cm TiN	Filling instrument – angled hollow handle TiN; 0,6/0,8 mm; 16,7 cm	84
151 56 0196	Cpátko oboustranné; 1,2/1,6 mm; 16,8 cm	Filling instrument – angled hollow handle; 1,2/1,6 mm; 16,8 cm	84
151 56 0197	Cpátko oboustranné; 1,2/1,6 mm; 16,8 cm TiN	Filling instrument – angled hollow handle TiN; 1,2/1,6 mm; 16,8 cm	84

číslo – number	název	item	strana – page
151 56 0206	Cpátko oboustranné; 2,0/2,5 mm; 16,8 cm	Filling instrument – angled hollow handle; 2,0/2,5 mm; 16,8 cm	84
151 56 0207	Cpátko oboustranné; 2,0/2,5 mm; 16,8 cm TiN	Filling instrument – angled hollow handle TiN; 2,0/2,5 mm; 16,8 cm	84
151 56 0246	Hladítko se cpátkem fig. 2; 16,6 cm	Spatula – filling instrument hollow handle; 16,6 cm	86
151 56 0247	Hladítko se cpátkem fig. 2; 16,6 cm TiN	Spatula – filling instrument hollow handle TiN; 16,6 cm	86
151 56 0286	Cpátko oboustranné; 1,0/1,8 mm; 16,6 cm	Filling instrument – angled hollow handle; 1,0/1,8 mm; 16,6 cm	83
151 56 0287	Cpátko oboustranné; 1,0/1,8 mm; 16,6 cm TiN	Filling instrument – angled hollow handle TiN; 1,0/1,8 mm; 16,6 cm	83
151 56 0296	Cpátko oboustranné; 1,4/2,0 mm; 16,6 cm	Filling instrument – angled hollow handle; 1,4/2,0 mm; 16,6 cm	83
151 56 0297	Cpátko oboustranné; 1,4/2,0 mm; 16,6 cm TiN	Filling instrument – angled hollow handle TiN; 1,4/2,0 mm; 16,6 cm	83
151 56 0306	Cpátko oboustranné; 0,6/0,8 mm; 16,6 cm	Filling instrument – angled hollow handle; 0,6/0,8 mm; 16,6 cm	83
151 56 0316	Cpátko kopýtkové oboustranné; 16,6 cm	Filling instrument – angled hollow handle; 16,6 cm	83
151 56 0317	Cpátko kopýtkové oboustranné; 16,6 cm TiN	Filling instrument – angled hollow handle TiN; 16,6 cm	83
151 56 0326	Cpátko oboustranné; 16,6 cm	Filling instrument – angled hollow handle; 16,6 cm	82
151 56 0346	Hladítko se cpátkem fig. 3; 16,6 cm	Spatula – filling instrument hollow handle; 16,6 cm	86
151 56 0347	Hladítko se cpátkem fig. 3; 16,6 cm TiN	Spatula – filling instrument hollow handle TiN; 16,6 cm	86
151 56 0356	Hladítko se cpátkem; 1,0/1,5 mm; 16,4 cm	Spatula – filling instrument hollow handle; 1,0/1,5 mm; 16,4 cm	86
151 56 0416	Nosič amalgamu; 1,4/2,0 mm; 16,6 cm	Carrier hollow handle; 1,4/2,0 mm; 16,6 cm	81
151 56 0426	Nosič amalgamu; 2,5/3,0 mm; 16,6 cm	Carrier hollow handle; 2,5/3,0 mm; 16,6 cm	81
151 56 0466	Cpátko vlákna do sulku; 2 mm; 16,6 cm	Fibre filling instrument hollow handle; 2 mm; 16,6 cm	85
151 56 0516	Zavaděč retrakčních vláken (přední zuby), 2,5 mm; 16,8 cm	Retentive fibre instrument; 16,8 cm	85
151 56 0526	Zavaděč retrakčních vláken (zadní zuby), 2,5 mm; 16,8 cm	Retentive fibre instrument; 16,8 cm	85
151 56 0616	Nástroj na plast. výplně; 16,6 cm	Instrument for malleable fillings; 16,6 cm	92
151 56 0626	Hladítko oboustranné fig. 1; 16,6 cm	Spatula hollow handle; 16,6 cm	89
151 56 0627	Hladítko oboustranné fig. 1; 16,6 cm TiN	Spatula hollow handle tin; 16,6 cm TiN	89
151 56 0636	Hladítko oboustranné fig. 2; 16,6 cm	Spatula hollow handle; 16,6 cm	89
151 56 0637	Hladítko oboustranné fig. 2; 16,6 cm TiN	Spatula hollow handle TiN; 16,6 cm TiN	89
151 56 0656	Hladítko oboustranné 3× lomené; 16,6 cm	Spatula 3× angled hollow handle; 16,6 cm	88
151 56 0657	Hladítko oboustranné 3× lomené; 16,6 cm TiN	Spatula 3× angled hollow handle tin; 16,6 cm TiN	88
151 56 0696	Hladítko oboustranné; 1,5 mm; 16,6 cm	Spatula – filling instrument hollow handle; 1,5 mm; 16,6 cm	89
151 56 0706	Heidemann hladítko oboustranné fig. 1; 16,6 cm	Heidemann spatula hollow handle; 16,6 cm	89
151 56 0716	Heidemann hladítko oboustranné fig. 2; 16,9 cm	Heidemann spatula hollow handle; 16,9 cm	89
151 56 0726	Heidemann hladítko oboustranné fig. 2; 17,3 cm	Heidemann spatula hollow handle; 17,3 cm	89
151 56 0806	Nástroj na modelování výplní; 1,6 mm; 16,4 cm	Filling instrument hollow handle; 1,6 mm; 16,4 cm	90
151 56 0836	Nástroj na modelování výplní; 2,5 mm; 16,4 cm	Filling instrument hollow handle; 2,5 mm; 16,4 cm	90
151 56 0846	Nástroj na modelování výplní; 2,5 mm; 16,4 cm	Filling instrument hollow handle; 2,5 mm; 16,4 cm	90
151 56 0856	Sapin nástroj na modelování výplní; 1,6 mm; 16,0 cm	Sapin filling instrument hollow handle; 1,6 mm; 16,0 cm	90
151 56 0866	Frahm nástroj na modelování výplní; 5,0 mm; 16,6 cm	Frahm filling instrument hollow handle; 5,0 mm; 16,6 cm	90
151 56 0876	Nástroj na modelování výplní; 1,4 mm; 16,6 cm	Filling instrument hollow handle; 1,4 mm; 16,6 cm	90
151 56 0886	Nástroj na modelování výplní; 1,6/2,5 mm; 16,4 cm	Filling instrument hollow handle; 1,6/2,5 mm; 16,4 cm	91
151 56 0887	Nástroj na modelování výplní; 1,6/2,5 mm; 16,4 cm TiN	Filling instrument hollow handle TiN; 1,6/2,5 mm; 16,4 cm	91
151 56 0896	Nástroj na modelování výplní; 2,2 mm; 16,8 cm	Modelling instrument hollow handle; 2,2 mm; 16,8 cm	92
151 56 0916	Nástroj na výplně ostrý; 16,6 cm	Modelling instrument hollow handle; 16,6 cm	90
151 56 0936	Discoïd-Cleoid nástroj na výplně; 2,0/2,2 mm; 16,8 cm	Discoïd-Cleoid filling instrument hollow handle TiN; 2,0/2,2 mm; 16,8 cm	92
151 56 0946	Nástroj na výplně; 2,5/3,0 mm; 16,6 cm	Plastic filling instrument – plugger hollow handle; 2,5/3,0 mm; 16,6 cm	91
151 56 1496	Wiland nástroj na výplně oboustranný; 16,6 cm	Wiland amalgam carver double-faced; 16,6 cm	90
151 56 3006	Cpátko oboustran.kombinované; 0,8/1,0 mm; 16,6 cm	Filling instrument – angled hollow handle; 0,8/1,0 mm; 16,6 cm	83
151 56 3016	Cpátko oboustran.kombinované; 1,2/1,4 mm; 16,6 cm	Filling instrument – angled hollow handle; 1,2/1,4 mm; 16,6 cm	83
151 56 3026	Cpátko oboustran.kombinované; 1,6/2,0 mm; 16,6 cm	Filling instrument – angled hollow handle; 1,6/2,0 mm; 16,6 cm	83
151 56 3056	Cpátko kuličkové s hladítkem; 1,2/1,5 mm; 16,6 cm	Plastic filling instrument – spatula-plugger hollow handle; 1,2/1,5 mm; 16,6 cm	87
151 56 3076	Cpátko kuličkové s hladítkem; 2,0/2,5 mm; 16,8 cm	Plastic filling instrument – spatula-plugger hollow handle; 2,0/2,5 mm; 16,8 cm	87
151 56 3116	Cpátko oboustranné oválné; 2,0×1,0 mm; 16,4 cm	Plastic filling instrument – plugger hollow handle; 2,0×1,0 mm; 16,4 cm	82
151 56 3126	Cpátko oboustranné oválné; 3,0×1,5 mm; 16,5 cm	Plastic filling instrument – plugger hollow handle; 3,0×1,5 mm; 16,5 cm	82
151 56 3146	Cpátko oboustranné oválné; 2,0×1,0 mm; 16,4 cm	Plastic filling instrument – plugger hollow handle; 2,0×1,0 mm; 16,4 cm	82
151 56 3156	Cpátko oboustranné oválné; 3,0×1,5 mm; 16,5 cm	Plastic filling instrument – plugger hollow handle; 3,0×1,5 mm; 16,5 cm	82
151 56 3186	Planátor; 1,4/1,7 mm; 16,1 cm	Amalgam condenser hollow handle; 1,4/1,7 mm; 16,1 cm	91
151 56 3196	Planátor; 1,9/2,3 mm; 16,6 cm	Amalgam condenser hollow handle; 1,9/2,3 mm; 16,6 cm	91
151 56 3256	Cpátko kuličkové s hladítkem; 1,2/1,5 mm; 16,4 cm	Plastic filling instrument – spatula-plugger hollow handle; 1,2/1,5 mm; 16,4 cm	87
151 56 3266	Cpátko kuličkové s hladítkem; 1,6/2,0 mm; 16,4 cm	Plastic filling instrument – spatula-plugger hollow handle; 1,6/2,0 mm; 16,4 cm	87
151 56 3286	Cpátko kuličkové s hladítkem; 2,5/3,0 mm; 16,8 cm	Plastic filling instrument – spatula-plugger hollow handle; 2,5/3,0 mm; 16,8 cm	87
151 56 3626	Hladítko oboustranné jemné fig. 1; 16,6 cm	Spatula hollow handle; 16,6 cm	89
151 56 3627	Hladítko oboustranné jemné fig. 1; 16,6 cm TiN	Spatula hollow handle TiN; 16,6 cm TiN	89
151 56 3636	Hladítko oboustranné jemné fig. 2; 16,6 cm	Spatula hollow handle; 16,6 cm	89
151 56 3637	Hladítko oboustranné jemné fig. 2; 16,6 cm TiN	Spatula hollow handle TiN; 16,6 cm TiN	89
151 56 3656	Hladítko oboustranné jemné 3× lomené; 16,6 cm	Spatula 3× angled hollow handle; 16,6 cm	88
151 56 3657	Hladítko oboustranné jemné 3× lomené; 16,6 cm TiN	Spatula 3× angled hollow handle TiN; 16,6 cm TiN	88
152	Ortodoncie, Zubní náhrady	Orthodontic, Tooth Replacement	
152 52 1900	Zesilovací mřížka zlacená; 60×54×12 mm	Mesh strengthener; 60×54×12 mm	132
152 52 1910	Zesilovací mřížka nerezová; 60×54×12 mm	Mesh strengthener; 60×54×12 mm	132
154	Otiskovací lžice	Impression Trays	
154 52 0110	Lžice otiskovací; BOX1	Impression tray; BOX1	133
154 52 0120	Lžice otiskovací; BOX2	Impression tray; BOX2	133
154 52 0130	Lžice otiskovací; BOX3	Impression tray; BOX3	133
154 52 0140	Lžice otiskovací; BOX4	Impression tray; BOX4	133
154 52 0260	Lžice otiskovací; FX1	Impression tray; FX1	133
154 52 0270	Lžice otiskovací; FX2	Impression tray; FX2	133
154 52 0280	Lžice otiskovací; FX3	Impression tray; FX3	133
154 52 0290	Lžice otiskovací; FX4	Impression tray; FX4	133
154 52 0360	Lžice otiskovací; DHX1	Impression tray; DHX1	134



číslo – number	název	item	strana – page
154 52 0370	Lžice otiskovací; DHX2	Impression tray; DHX2	134
154 52 0380	Lžice otiskovací; DHX3	Impression tray; DHX3	134
154 52 0460	Lžice otiskovací; DDX1	Impression tray; DDX1	134
154 52 0470	Lžice otiskovací; DDX2	Impression tray; DDX2	134
154 52 0480	Lžice otiskovací; DDX3	Impression tray; DDX3	134
154 52 0550	Lžice otiskovací; PPX	Impression tray; PPX	133
154 52 0560	Lžice otiskovací; PLX	Impression tray; PLX	133
154 52 0600	Lžice otiskovací korunková	Crown impression tray	133
154 52 0610	Lžice otiskovací; FOX1	Impression tray; FOX1	134
154 52 0620	Lžice otiskovací; FOX2	Impression tray; FOX2	134
154 52 0630	Lžice otiskovací; FOX3	Impression tray; FOX3	134
154 52 0640	Lžice otiskovací; FOX4	Impression tray; FOX4	134
154 52 0660	Lžice otiskovací; UUX1	Impression tray; UUX1	134
154 52 0670	Lžice otiskovací; UUX2	Impression tray; UUX2	134
154 52 0680	Lžice otiskovací; UUX3	Impression tray; UUX3	134
154 52 0690	Lžice otiskovací; UUX4	Impression tray; UUX4	134
154 52 0790	Lžice otiskovací; BOXC3	Impression tray; BOXC3	134
154 52 0820	Lžice otiskovací; FXC2	Impression tray; FXC2	134
154 52 0830	Lžice otiskovací; FXC3	Impression tray; FXC3	134
154 52 1550	Soubor otiskovacích lžic perforovaných; 9 ks	Set of impression perforated trays; 9 pcs	133
154 52 1650	Soubor otiskovacích lžic dětských perforovaných; 6 ks	Set of impression perforated trays for children	134
154 52 9010	Lžice otiskovací-nerez; H1	Impression tray-stainless steel; H1	133
154 52 9011	Lžice otiskovací-nerez; H2	Impression tray-stainless steel; H2	133
154 52 9012	Lžice otiskovací-nerez; H3	Impression tray-stainless steel; H3	133
154 52 9013	Lžice otiskovací-nerez; H4	Impression tray-stainless steel; H4	133
154 52 9014	Lžice otiskovací-nerez; D1	Impression tray-stainless steel; D1	133
154 52 9015	Lžice otiskovací-nerez; D2	Impression tray-stainless steel; D2	133
154 52 9016	Lžice otiskovací-nerez; D3	Impression tray-stainless steel; D3	133
154 52 9017	Lžice otiskovací-nerez; D4	Impression tray-stainless steel; D4	133
154 52 9018	Lžice otiskovací-nerez; HX1	Impression tray-stainless steel; HX1	133
154 52 9019	Lžice otiskovací-nerez; HX2	Impression tray-stainless steel; HX2	133
154 52 9020	Lžice otiskovací-nerez; HX3	Impression tray-stainless steel; HX3	133
154 52 9021	Lžice otiskovací-nerez; HX4	Impression tray-stainless steel; HX4	133
154 52 9022	Lžice otiskovací-nerez; DX1	Impression tray-stainless steel; HX1	133
154 52 9023	Lžice otiskovací-nerez; DX2	Impression tray-stainless steel; DX2	133
154 52 9024	Lžice otiskovací-nerez; DX3	Impression tray-stainless steel; DX3	133
154 52 9025	Lžice otiskovací-nerez; DX4	Impression tray-stainless steel; DX4	133
<b>155</b>	<b>Nástroje modelovací</b>	<b>Modelling Instruments</b>	
155 52 0180	Le Cron nástroj modelovací; 17,5 cm	Le Cron modelling instrument; 17,5 cm	124, 125
155 52 0212	Nůž modelovací; 13,0 cm	Modelling knife; 13,0 cm	124, 125
155 52 0222	Nůž modelovací; 17,4 cm	Modelling knife; 17,4 cm	124, 125
155 52 1402	Nástroj modelovací fig. 1; 16,2 cm	Modelling instrument fig. 1; 16,2 cm	126, 127
155 52 1412	Nástroj modelovací fig. 2; 16,4 cm	Modelling instrument fig. 2; 16,4 cm	126, 127
155 52 1422	Nástroj modelovací fig. 3; 16,7 cm	Modelling instrument fig. 3; 16,7 cm	126, 127
155 52 1432	Nástroj modelovací fig. 4; 16,5 cm	Modelling instrument fig. 4; 16,5 cm	126, 127
155 52 1442	Nástroj modelovací fig. 5; 16,2 cm	Modelling instrument fig. 5; 16,2 cm	126, 127
155 52 1452	Nástroj modelovací fig. 6; 16,8 cm	Modelling instrument fig. 6; 16,8 cm	126, 127
155 52 1462	Nástroj modelovací fig. 7; 15,6 cm	Modelling instrument fig. 7; 15,6 cm	126, 127
155 52 1472	Nástroj modelovací fig. 8; 15,9 cm	Modelling instrument fig. 8; 15,9 cm	126, 127
155 52 1482	Nástroj modelovací fig. 9; 15,9 cm	Modelling instrument fig. 9; 15,9 cm	126, 127
155 52 9000	Sada modelovacích nástrojů	Set of modelling instruments	127
<b>156</b>	<b>Matrice</b>	<b>Matrix Bands</b>	
156 52 0010	Ivory matrice na tvarování výplní malá; 2,5 cm	Ivory matrix band small; 2,5 cm	96
156 52 0020	Ivory matrice na tvarování výplní střední; 3,6 cm	Ivory matrix band medium; 3,6 cm	96
156 52 0030	Ivory matrice na tvarování výplní velká; 3,5 cm	Ivory matrix band large; 3,5 cm	96
156 52 0050	Ivory napínač matric; 7,0 cm	Ivory matrix retainer; 7,0 cm	96
156 52 0070	Ivory separátor; 6,7 cm	Ivory separator; 6,7 cm	96
156 52 0300	Napínač matric; 6,4 cm	Universal retainer; 6,4 cm	97
156 91 0001	Matrice pásková; 5 mm; 1 m	Matrix band; 5 mm; 1 m	97
156 91 0002	Matrice pásková; 6 mm; 1 m	Matrix band; 6 mm; 1 m	97
156 91 0003	Matrice pásková; 7 mm; 1 m	Matrix band; 7 mm; 1 m	97
<b>157</b>	<b>Kyvety, třmeny, lisy</b>	<b>Flasks, Claps, Presses</b>	
157 52 0011	Kyveta korunková	Crown flask	130
157 52 0021	Kyveta čtyřdílná nerezová	Four-piece flask stainless	130
157 52 0030	Třmen pro jednu kyvetu; 17,0 cm	Clap for one flask; 17,0 cm	129
157 52 0031	Kyveta čtyřdílná mosazná	Four-piece flask brass	130
157 52 0040	Třmen pro dvě kyvety; 22,5 cm	Clap for two flasks; 22,5 cm	129
157 52 0050	Třmen pro tři kyvety; 28,0 cm	Clap for three flasks; 28,0 cm	129
157 52 0210	Opěrka kyvety korunkové	Support of crown flask	130
<b>158</b>	<b>Pomůcky pro lití</b>	<b>Casting Devices</b>	
158 52 0010	Kroužek kovový licí; 22×30 mm	Casting ring; 22×30 mm	132
158 52 0020	Kroužek kovový licí; 28×40 mm	Casting ring; 28×40 mm	132
158 52 0030	Kroužek kovový licí; 40×45 mm	Casting ring; 40×45 mm	132
158 52 0040	Kroužek kovový licí; 40×48 mm	Casting ring; 40×48 mm	132
158 52 0050	Kroužek kovový licí; 50×55 mm	Casting ring; 50×55 mm	132
158 52 0060	Kroužek kovový licí; 60×55 mm	Casting ring; 60×55 mm	132
158 52 0070	Kroužek kovový licí; 70×55 mm	Casting ring; 70×55 mm	132

číslo – number	název	item	strana – page
<b>158 52 0080</b>	Kroužek kovový licí; 80×55 mm	Casting ring; 80×55 mm	132
<b>158 52 0090</b>	Kroužek kovový licí; 25×35 mm	Casting ring; 25×35 mm	132
<b>158 91 0001</b>	Podložka pod licí kroužky; 9,0 cm	Washer for casting rings; 9,0 cm	131
<b>158 99 0022</b>	Kroužek kovový licí; 38×55 mm	Casting ring; 38×55 mm	131
<b>158 99 0023</b>	Kroužek kovový licí; 48×55 mm	Casting ring; 48×55 mm	131
<b>158 99 0024</b>	Kroužek kovový licí; 65×55 mm	Casting ring; 65×55 mm	131
<b>158 99 0025</b>	Kroužek kovový licí; 30×55 mm	Casting ring; 30×55 mm	131
<b>158 99 0026</b>	Kroužek kovový licí; 80×55 mm	Casting ring; 80×55 mm	131
<b>159</b>	<b>Pomocné vybavení</b>	<b>Auxiliary Devices</b>	
<b>159 53 0050</b>	Nádobka na vatu s pružinou	Cotton wool box with spring	137
<b>159 53 0060</b>	Nádobka na vatové odpadky	Cotton wool container	137
<b>159 53 0100</b>	Držátko ubrousku řetízkové, UH svorky; 47,0 cm	Napkin holder with metal chain; 47 cm	137
<b>159 53 0110</b>	Držátko ubrousku UH, kovové svorky; 48,0 cm	Napkin holder; 48 cm	137
<b>159 53 0120</b>	Držátko ubrousku řetízkové, kovové svorky 23,0 cm	Napkin holder with metal chain; 23 cm	137
<b>285 499 54 7000</b>	Plomba pro sterilizační kontejnery	Seal for sterilizing containers	147

# Jmenný rejstřík – český

## Alphabetical index – Czech

<b>A</b>			
Adson pinzeta anatomická	68		
<b>B</b>			
Babcock svorka chirurgická	46		
Backhaus svorka na prádlo	48		
Backhaus-Clip svorka na prádlo	48		
Barry páka extrakční	25		
Bein páka extrakční	21–22		
Black dlátka na sklovinu	110–111		
Black škrabka na zubní kámen	108		
Blumenthal kleště štípací na kosti	16		
Boynton jehelec oční	52		
Brünnings lopatka na jazyk	74		
Buben sterilizační	142-143		
Buchwald lopatka na jazyk	74		
<b>C</b>			
Castroviejo jehelec	53		
Castroviejo jehelec mikro	53		
Castroviejo nůžky na duhovku	62		
Castroviejo nůžky oční	62		
Cleveland kleště štípací na kosti	16		
Collin kleště na jazyk	19		
Cpátka amalgamu oboustranné	82		
Cpátka kombinované oboustranné	83		
Cpátka kompozitních materiálů oboustranné	82		
Cpátka kopýtkové oboustranné	83		
Cpátka kořenové jednostranné	84		
Cpátka kuličkové s hladítkem	87		
Cpátka oboustranné	82–84		
Cpátka oválné oboustranné	82		
Cpátka vlákna do sulku	85		
Crile jehelec jemný	50, 52		
Cushing háček jemný	32		
<b>Č</b>			
Čepelka skalpelová	43		
<b>D</b>			
De Bakey pinzeta atraumatická	69		
De Bakey-Mosquito svorka atraumatická	47		
De Bakey-Pean svorka atraumatická	47		
Desmarres háček jemný	32		
Dieffenbach skalpel oční	41		
Discoïd-Cleoid nástroj na výplně	92		
Dlaha dentální prefabrikovaná	54		
Dláto ploché jemné	28		
Dláto poloklínové jemné	29		
Dláto žlábkové	28		
Dláto žlábkové jemné	29		
Drápek na zubní kámen	106		
Držák	76, 139		
Držátko skalpelových čepelk	42, 127		
Držátko ubrousku řetízkové	137		
Držátko zubního zrcátka	75, 76		
<b>E</b>			
Exkavátor jednostranný zahnutý	79		
Exkavátor oboustranný	76, 80		
Explorer	101		
<b>F</b>			
Filtr	147		
Flohr páka extrakční	22		
Frahm nástroj na modelování výplní	90		
Freer páčidlo na nosní přepážku	20		
Freer páčidlo nosní	20		
Friedman kleště štípací na kosti	16		
Furkační kyreta	105		
<b>G</b>			
Gillies pinzeta chirurgická	68		
Goldman-Fox nůžky na dásně	56		
Gomel nůžky mikro	63		
Gracey kyreta	102, 104		
Graefe pinzeta fixační	70		
Graefe pinzeta oční	70		
<b>H</b>			
Háček na rány	31		
Háček oční	33		
Háček pro plastiku	33		
Hák intraorální	36		
Hák resekční	35		
Halsted-Mosquito svorka na cévy	45		
Hartmann svorka	45		
Heidemann hladítka	89		
Heister rozvěrač úst	37		
Heywood-Smith kleště tamponové	19		
Hladítka oboustranné	88, 89		
Hladítka pružná	88		
Hladítka se cpátkem	86		
<b>I</b>			
Ivory matrice na tvarování výplní	96		
Ivory napínač matric	96		
Ivory separátor	96		
<b>J</b>			
Jabaley-Stille nůžky micro super cut	60		
Jacobson jehelec mikro	53		
Jansen kleště štípací	17		
Jehelec hloubkový rovný	50, 51		
Jehelec s vnitřním uzávěrem	50		
Jennings rozvěrač úst	37		
Jeweler pinzeta	68		
Joseph háček na rány	31		
Joseph pilník	27		
<b>K</b>			
Kazeta pro stomatologické nástroje	76, 139		
Kazeta s držákem	139		
Kelly svorka na cévy zahnutá	46		
Kladívko chirurgické kovové	30		
Kladívko laboratorní ocelové	128		
Kleště extrakční	11–15		
Kleště k odstranění kořenových nástrojů	15		
Kleště laboratorní	116, 124		
Kleště laboratorní čočkové	116		
Kleště laboratorní kuželové	116		
Kleště laboratorní oblé	116		
Kleště laboratorní ohýbací	117, 118		
Kleště laboratorní ploché	116, 117		
Kleště laboratorní utahovací	118		

Kleště na kelímky	115
Kleště štípací	18
Kleště štípací na drát	115
Kontejner ½	144
Kontejner dentální	145
Kontejner mini	146
Koš síťový	144–146
Krabička kulatá	139
Krabička na katetry	140
Krabička na umělý chrup	141
Krabička s bočními prohlubněmi	141
Krabička s poklopem	140
Krabička s přihrádkami	140
Krabička s rovným víkem	140
Krabička s vypouklým víčkem	140
Krabička sterilizační	140
Kroužek kovový lící	131, 132
Kyveta čtyřdílná	130
Kyveta korunková	130

## L

Langenbeck hák na rány	35
Langenbeck chránič prstu	36
Langenbeck páčidlo	20
Langenbeck škrabka	26
Le Cron nástroj modelovací	124, 125
Lecluse páka extrakční	25
List k pilce upínací stomatologické	122
Lister kleště tamponové	19
Lister nůžky na obvazy	55
Liston kleště štípací	18
Littauer nůžky pro ligaturu	57
Löbker kleště na jazyk	19
Lopatka na cement	95, 123
Lopatka na míchání otiskovacích hmot	95, 123
Lopatka na sádro	123
Lorna svorka na prádlo	49
Luer kleště štípací na kosti	16, 17
Luniatschek zavaděč drenů	54
Lžice otiskovací	133, 134
Lžice otiskovací korunková	133
Lžička exkochleační	40
Lžička laboratorní	123
Lžička oboustranná	38
Lžička ostrá	39
Lžička ostrá oboustranná	38

## M

Mathieu jehelec	50, 52
Matrice pásková	97
Micro-Mosquito svorka na cévy	45
Middeldorpf hák na rány	34
Mini Gracey kyreta	103, 104
Mini-Friedman kleště štípací na kosti	16
Mini-Langenbeck háček jemný	32
Mod. Bonn nůžky	60
Mosquito-Halsted svorka na cévy	44, 124, 127

## N

Nabers furkační sonda	101
Nádobka kovová	139
Nádobka medicínská kovová	139
Nádobka na vatové odpadky	137
Nádobka na vatu s pružinou	137
Nádobka oválná – emitní miska	139
Napínač matric	97
Nástroj modelovací	126, 127
Nástroj na modelování výplní	90–92
Nástroj na plastické výplně	92
Nástroj na snímání korunek	98
Nástroj na výplně	90–91
Nástroj na zubní kámen	106, 109
Nástroj pro výplně	90

Nosič amalgamu	81
Noyes nůžky na duhovku	62
Nůž modelovací	124, 125
Nůž na dásně oboustranný	40
Nůž na gingivektomii	40
Nůž na sádro s otvíračem kyvet	123, 124
Nůžky	61
Nůžky chirurgické	59
Nůžky lomené	61
Nůžky mikro	63
Nůžky na dásně	56
Nůžky na korunky	122
Nůžky rovné	61
Nůžky zahnuté	61

## O

Obtahovací kamínek na ostření kyret	105
Oehler pinzeta chirurgická	68
Olsen-Hegar jehelec/nůžky	51
Opěrka kyvety korunkové	130

## P

Páčidlo na nosní přepážku	20
Páka extrakční	23
Páka extrakční se zuby	25
Pásek separační diamantovaný	93
Pásek separační hladký	93
Pátradlo zubní háčkové	73
Pátradlo zubní obloukové	73
Pátradlo zubní vyhnuté	73, 76
Peers svorka na prádlo	49
Pilník	27
Pilník diamantovaný	112
Pinzeta anatomická	65, 127
Pinzeta cévní atraumatická	69
Pinzeta chirurgická	67
Pinzeta laboratorní	121
Pinzeta na kořenové čípky	64
Pinzeta šicí	67
Pinzeta zkřížená	121
Pinzeta zkřížená se šroubovákem	121
Pinzeta zubní	64, 76, 124
Pistole na amalgam	94
Planátor	91
Plomba pro sterilizační kontejnery	147
Podložka pod lící kroužky	131
Podložka silikonová	148
Přecechtěl škrabka nosní	26

## Q

Quinby nůžky na dásně	56
-----------------------	----

## R

Rám napínací	144–146
Rám upínací pilky stomatologické	122
Reynolds nůžky preparační	57
Roeder svorka na prádlo	49
Rochester-Pean svorka na cévy	46
Roser-König rozvěrač úst	37
Rouška textilní zelená	148
Ryder jehelec	51

## S

Sada modelovacích nástrojů	127
Sanvenero nůžky preparační	57
Sapin nástroj na modelování výplní	90
Scaler oboustranný	104, 105
Semken pinzeta anatomická	68
Schlemmer páka extrakční	23
Síto oddělovací	144
Sonda parodontologická	101

Sonda parodontologická s pátradlem	101
Soubor otiskovacích lžic	133
Soubor otiskovacích lžic dětských	134
Soubor parodontologických nástrojů	104
Soubor pro zubní techniky	124
Soubor základních stomatologických nástrojů	76
Spencer nůžky pro ligaturu	57
Srpek na zubní kámen	76, 106, 107
Standard nůžky chirurgické	58, 59
Standard pinzeta anatomická	66
Standard pinzeta chirurgická	66, 67
Stellbrink kleště štípací na kosti	16
Stevens nůžky micro super cut	60
Stille nůžky micro super cut	60
Svorka na separační pásky	93

## Š

Škrabka na operaci slzného vaku	26
Škrabka na zubní kámen	107, 108
Špinar páka extrakční	24
Štítek identifikační	147

## T

Tácek	141
Tácek dentální	141
Testovací tyčinka PMMA	105
Tohoku-Japan svorka na prádlo	49
Toulec na kleště	138
Toulec na pinzety	138
Třmen pro kyvety	129

## U

Utahovací klíček	42
------------------	----

## V

Vana neperforovaná	144–146
Vana perforovaná	144–146
Víko neperforované	144–146
Víko ochranné	144
Víko perforované	144–146
Vložka síťová	146

## W

Wagner nůžky	60
West dláto žlábkové	28
White páka extrakční	24, 25
Whitehead rozvěrač úst	37
Wiland nástroj na výplně	90
Williger páčidlo	20
Williger škrabka	26

## Z

Zámek bezpečnostní plastový	147
Zavaděč retrakčních vláken	85
Zesilovací mřížka	132
Zešikmovač gingiválních okrajů	108
Zrcátko intraorální	74
Zrcátko zubní	75, 76

### A

Adson forceps	68
Amalgam condenser	91
Amalgam gun	94

### B

Babcock tissue seizing forceps	46
Backhaus towel forceps	48
Backhaus-Clip towel forceps	48
Barry root elevator	25
Bein root elevator	21, 22
Black enamel chisel	110, 111
Black scaler	108, 111
Blade of stomatological saw	122
Blumenthal bone ronguers	16
Bone curette	40
Bone curette double-faced	38
Bone rongeurs	18
Bottom non perforated	144–146
Bottom perforated	144–146
Bowl	139
Box	140, 141
Box for denture	141
Box round	139
Boynton eye needle holder	50
Brünnings tongue spatula	74
Buchwald tongue spatula	74

### C

Carrier hollow handle	81
Cassette	76, 139
Cassette with holder	139
Casting ring	131, 132
Castroviejo eye scissors	62
Castroviejo iris scissors	62
Castroviejo micro-needle holder	53
Castroviejo needle holder	53
Cement spatula	95, 123
Chisel flat fine	28
Chisel grooved fine	29
Chisel half-wedged fine	29
Clap for flasks	129
Cleveland bone ronguers	16
Cloth green	148
Collin tongue holding forceps	19
Container ½	144
Cotton wool box	137
Crile needle holder	50, 52
Cross-action forceps	121
Cross-action forceps with screwdriver	121
Crown flask	130
Crown impression tray	133
Crown remover	98
Crown scissors	122
Crucible forceps	115
Cushing delicate hook	32
Cutting instrument	109

### D

De Bakey atrauma forceps	69
De Bakey-Mosquito atrauma forceps	47
De Bakey-Pean atrauma forceps	47
De Bakey-Rankin atrauma forceps	47
Delicate hook	31
Dental container	145

Dental forceps	64, 76, 124
Dental mirror	75
Dental probe	73, 76
Dental tray	141
Desmarres delicate hook	32
Diamond file	112
Dieffenbach knife	41
Discoïd-Cleoid filling instrument	92
Dissection micro scissors	63
Divider	144
Drape retainer dental	144–146
Dressing forceps	66

### E

Excavator curved	79
Excavator double-faced	76, 80
Excavator straight	79
Explorer	101
Extraction forceps	11–15
Eye hook	33

### F

Fibre filling instrument	85
Filling instrument	82–84, 90, 91
Filter	147
Flohr root elevator	22
Forceps for extraction of root instruments	15
Forceps quiver	138
Four-piece flask	130
Frahm filling instrument	90
Frahm modelling instrument	90
Frame of stomatological saw	122
Freer nasal elevator	20
Freer septum elevator	20
Friedman bone ronguers	16
Furcation curette	105

### G

Gillies tissue forceps	68
Gingival margin trimmer	108
Gingivectomy knife	40
Goldman-Fox scissors	56
Gomel dissection micro scissors	63
Gouge grooved	28
Gracey curette	102, 104
Graefe eye forceps	70
Graefe fixation forceps	70
Gum knife mutual	40
Gum scissors	56

### H

Halsted-Mosquito artery forceps	45
Hartmann forceps	45
Heidemann spatula	89
Heister mouth retractor	37
Heywood-Smith sponge holding forceps	19
Holder	76, 139

### I

Identification label	147
Impression tray	133, 134
Instrument for malleable fillings	92
Intraolar hook	36
Intraoral mirror	74

Ivory matrix band	96
Ivory matrix retainer	96
Ivory separator	96

## J

Jabaley-Stille scissors micro super cut	60
Jacobson micro-needle holder	53
Jansen mastoid forceps	17
Jennings mouth retractor	37
Jeweler forceps	68
Joseph delicate hook	31
Joseph rasp	27

## K

Kelly artery forceps	46
----------------------	----

## L

Label	147
Laboratory bending forceps	118
Laboratory forceps	116, 124
Laboratory forceps with conical jaws	116
Laboratory forceps with flat jaws	116, 117, 121
Laboratory forceps with groove jaws	117
Laboratory forceps with lens jaws	116
Laboratory forceps with rounded jaws	116
Laboratory mallet	128
Laboratory spoon	123
Laboratory tighten forceps	118
Lachrymal sac raspatory	26
Langenbeck elevator	20
Langenbeck finger protector	36
Langenbeck raspatory	26
Langenbeck retractor	35
Le Cron modelling instrument	124, 125
Lecluse root elevator	25
Lid non perforated	144–146
Lid perforated	144–146
Lister bandage scissors	55
Lister sinus forceps	19
Liston bone rongeurs	18
Littauer ligature scissors	57
Löbker tongue holding forceps	19
Lorna towel forceps	49
Luer bone rongeurs	16, 17
Luniatschek drain introducer	54

## M

Mathieu needle holder	50, 52
Matrix band	97
Mesh strengthener	132
Micro-Mosquito artery forceps	45
Middeldorpf retractor	34
Mini Gracey curette	103, 104
Mini-Friedman bone rongeurs	16
Mini-Langenbeck delicate hook	32
Mirror handle	75, 76
Mixing spatula	95, 123
Mod. Bonn extra delicate scissors	60
Modelling instrument	126, 127
Modelling instrument	90–92
Modelling knife	124, 125
Mosquito-Halsted artery forceps	44, 124, 127
Mouth mirror	75
Mouth mirror flat	75
Mouth mirror magnifying	75, 76

## N

Nabers furcation probe	101
Napkin holder	137
Needle holder	50, 51
Non-traumatic forceps	69

Noyes iris scissors	62
---------------------	----

## O

Oehler tissue forceps	68
Olsen-Hegar needle holder/scissors	51
Operating scissors	59

## P

Peers towel forceps	49
Periodontal and dental probe	101
Periodontal probe	101
Plaster knife	123, 124
Plaster spatula	123
Plastic filling instrument	88, 89, 92
Plastic filling instrument – carrier	81
Plastic filling instrument – plugger	82–84, 91
Plastic filling instrument – spatula	88, 89, 92
Plastic filling instrument – spatula/plugger	86, 87
Plastic hook	33
Plastic security seal	147
Plastic test stick	105
Prefabricated plate	54
Přecechtěl nasal raspatory	26

## Q

Quinby gum scissors	56
Quiver for forceps	138

## R

Rasp	27
Resection hook	35
Retentive fibre instrument	85
Reynolds dissecting scissors	57
Roeder towel forceps	49
Rochester-Pean artery forceps	46
Root elevator	23–25
Root suppository forceps	64
Roser-König mouth retractor	37
Ryder needle holder	51

## S

Safety lid	144
Sanvenero dissecting scissors	57
Sapin filling instrument	90
Sapin modelling instrument	90
Scaler	76, 106–108
Scaler double-faced	104, 105
Scalpel blade	43
Scalpel handle	42, 127
Scissors	61
Seal for sterilizing containers	147
Semken dissecting forceps	68
Separative strip diamond	93
Separative strip smooth	93
Septum nasal elevator	20
Set for dental technicians	124
Set of basic stomatological instruments	76
Set of impression trays	133
Set of impression trays for children	134
Set of modelling instruments	127
Set of periodontal instruments	104
Sharp spoon	39
Sharpening stone for curretes	105
Schlemmer root elevator	23
Silicon mat	148
Small set container	146
Spanner	42
Spatula	86, 88, 89
Spencer ligature scissors	57
Standard operating scissors	58, 59
Stellbrink bone rongeurs	16

Sterilization box	140
Sterilization drum	142, 143
Stevens scissors micro super cut	60
Stille scissors micro super cut	60
Strip clamp	93
Support of crown flask	130
Surgical mallet	30
Suture tying forceps	67
Špinar root elevator	24

## T

Tissue forceps	65–67, 127
Tohoku-Japan towel forceps	49
Tray	141
Tweezer quiver	138























## U

Universal retainer	97
--------------------	----

## W

Wagner fine scissors	60
Walton fine scissors	60
Washer for casting rings	131
West gouge grooved	28
Whitehead mouth retractor	37
Wiland amalgam carver	90
Williger elevator	20, 26
Wire base	146
Wire basket	144–146
Wire cutting forceps	115



	použit do	use by
	datum výroby	date of manufacture
	výrobce	manufacturer
	nepoužívat znovu	do not reuse
	neprovádět opětovnou sterilizaci	do not resterilize
	nepoužívat, jestliže je balení poškozeno	do not use if package is damaged
	otevřené balení nebude nahrazeno	opened packages are not replaced
	set, souprava	assortment
	pozor sledujte průvodní dokumentaci	caution, consult accompanying documents
	nesterilní	non sterile
	doporučené otáčky za minutu, doporučená frekvence otáčení XXX-XXX min <sup>-1</sup>	recommended rotation speed
	kód dávky	batch code
	katalogové číslo	catalogue number
	množství	quantity
	kontrola	control
	sterilní	sterile
	sterilizace ozářením	sterilization using irradiation
	sterilizace ethylenoxidem	sterilization using ethylene oxide
	sterilní zdravotnické prostředky zpracované aseptickou technologií	sterile by aseptic techniques
	diagnostický zdravotnický prostředek in vitro	in vitro diagnostic medical device
	globální nomenklatura zdravotnických prostředků	global medical device nomenclature code
	sledujte návod k použití	consult instructions for use



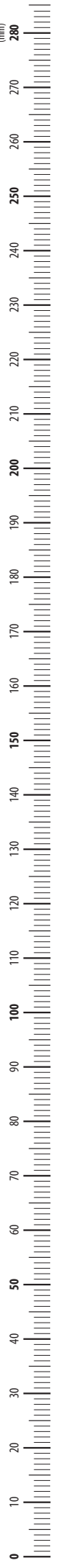



MEDIN, a.s.  
Vlachovická 619  
Nové Město na Moravě  
CZ 592 31  
Czech Republic  
IČO 43378030  
DIČ CZ43378030

[www.medin.cz](http://www.medin.cz)  
[www.medin.eu](http://www.medin.eu)

PRODEJ ČESKÁ REPUBLIKA  
tel.: 566 684 327  
fax: 566 684 384  
e-mail: [prodej@medin.cz](mailto:prodej@medin.cz)

EXPORT  
phone: +420 566 684 336  
fax: +420 566 684 385  
e-mail: [export@medin.cz](mailto:export@medin.cz)



2012